

# 1.0mm Pitch LIF Right Angle DIP FFC/FPC Connector

1.0A-WS-nPF

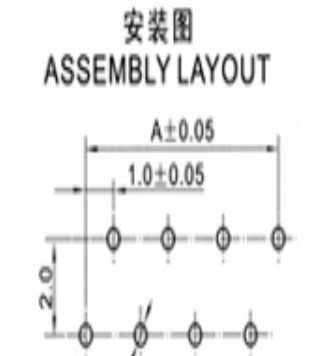

正针 PCB 寸法  
Positive needle PCB LAYOUT

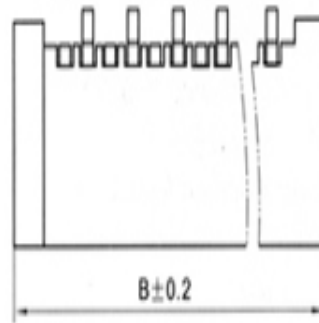
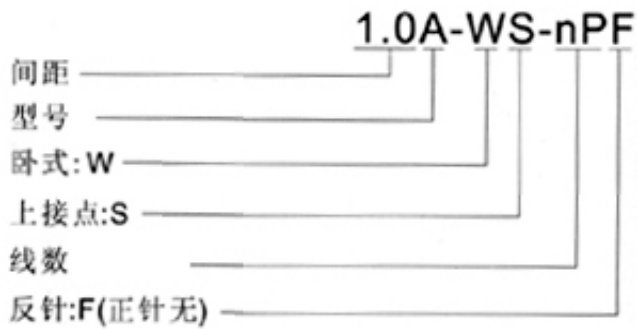
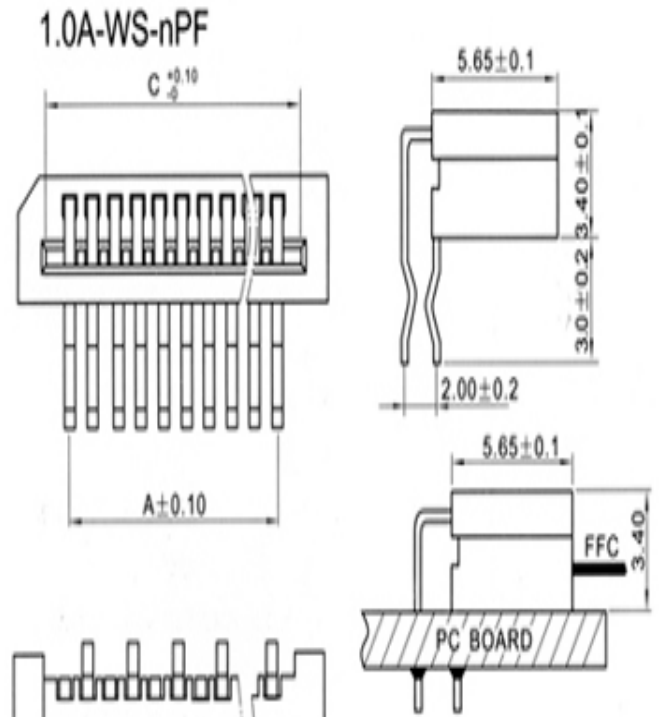
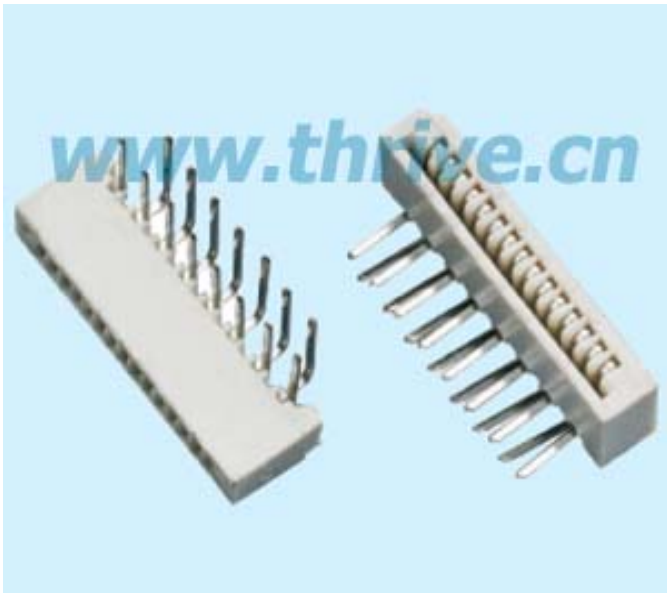
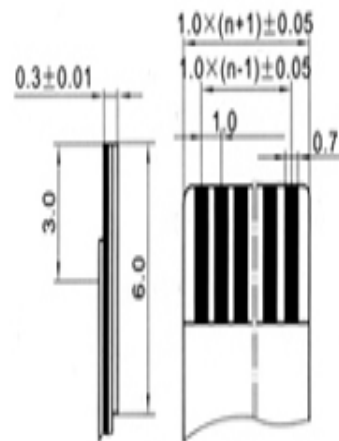

适用扁平电缆  
Proper cable

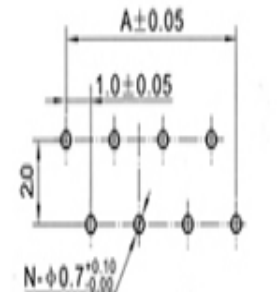

反针 PCB 寸法  
Versa needle PCB LAYOUT

## Contact parts

\*Material: Phosphor bronze

## Body:

\*Material: Nylon 46, UL94V-0

## Packing

- \* Brede
- \* Tube
- \* Bag

## Technology parameter

- \* Pin: 4 ~ 50
- \* Rated Voltage: AC、DC、200V (50HZ)
- \* Rating current: > 0.4A 、 AC、 DC
- \* Dielectric Withstanding Voltage :500V AC/m
- \* Operating Temperature: -25℃ ~+ 85℃
- \*Insulation Resistance:  $\geq 500M\Omega$
- \* Contact Resistance :  $\leq 0.02\Omega$
- \* Single side Contact

Pin	A	B	C	Pin	A	B	C	Pin	A	B	C
4	3	7.5	5.1	5	4	8.5	6.1	6	5	9.5	7.1
7	6	10.5	8.1	8	7	11.5	9.1	9	8	12.5	10.1
10	9	13.5	11.1	11	10	14.5	12.1	12	11	15.5	13.1
13	12	16.5	14.1	14	13	17.5	15.1	15	14	18.5	16.1
16	15	19.5	17.1	17	16	20.5	18.1	18	17	21.5	19.1
19	18	22.5	20.1	20	19	23.5	21.1	21	20	24.5	22.1
22	21	25.5	23.1	23	22	26.5	24.1	24	23	27.5	25.1
25	24	28.5	26.1	26	25	29.5	27.1	27	26	30.5	28.1
28	27	31.5	29.1	29	28	32.5	30.1	30	29	33.5	31.1
31	30	34.5	32.1	32	31	35.5	33.1	33	32	36.5	34.1
34	33	37.5	35.1	35	34	38.5	36.1	36	35	39.5	37.1
37	36	40.5	38.1	38	37	41.5	39.1	39	38	42.5	40.1
40	39	43.5	41.1								