

GSM/GPRS/GPS Vehicle Tracker USER MANUAL

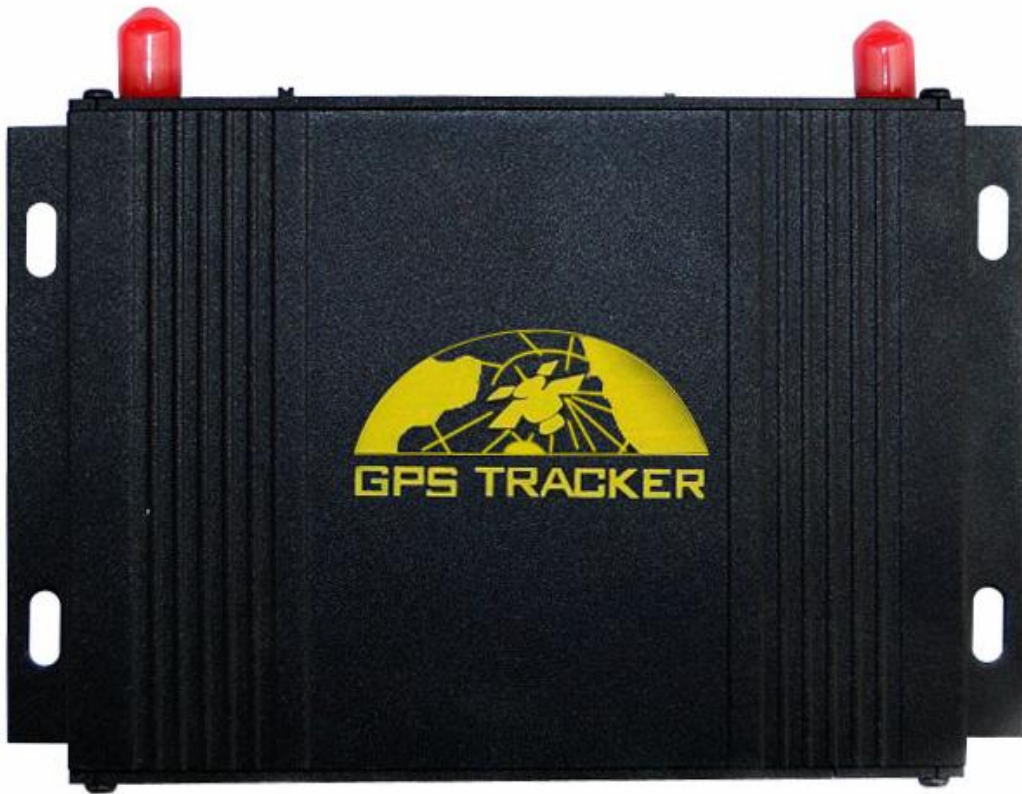

Preface

Thank you for purchasing the tracker. This manual shows how to operate the device smoothly and correctly. Make sure to read this manual carefully before using this product. Please note that specification and information are subject to changes without prior notice in this manual. Any change will be integrated in the latest release. The manufacturer assumes no responsibility for any errors or omissions in this document.

Contents

1.	Function introduction	5
2.	Applications.....	5
3.	Interface Schematic	5
4.	Accessories	6
5.	Specifications	8
6.	Installation	8
	6.1 Installation instructions.....	8
	6.2 Installation wiring diagram	9
	6.2.1 Main unit installation wiring diagram	9
	6.2.2 Relay box (JD01) wiring diagram	10
	6.2.3 Central locking system wiring diagram	10
	6.3 SIM Installation.....	10
7.	Function and Operation	11
	7.1 Turn on device.....	11
	7.2 GSM/GPS LED Indicator	11
	7.3 Alarming LED indicator	11
	7.4 Initialization	11
	7.5 Change Password	11
	7.6 Authorization	12
	7.7 Modes switch “track”, “monitor”& “call”	12
	7.8 Single Locating	12
	7.9 Auto track continuously.....	12
	7.9.1 Track with limited times upon time interval:.....	13
	7.9.2 Track with unlimited times upon time interval:	13
	7.9.3 Smart track upon time and distance interval:.....	13
	7.10 Automatic update positions of vehicle turns.....	13
	7.11 GPS drift suppression	13
	7.12 Absolute street address.....	13
	7.13 Location based service (LBS).....	13
	7.14 View photos on cell phone	14
	7.15 Storage.....	14
	7.15.1 Auto Storage.....	14
	7.15.2 Logging upon times	14
	7.15.3 Multi-logging	14
	7.15.4 Logging Clearance	14
	7.16 Data Load	14
	7.17 Forward the third parties’ message	14
	7.18 Charges Inquiry	15
	7.19 ACC working alarm.....	15
	7.20 Dialer (Optional)	15
	7.20.1 Picture of Dialer	15
	7.20.2 Dialer and remote controller program	15
	7.20.3 .Dial a Phone.....	16
	7.21 Remote controller (optional)	16
	7.21.1 SOS Emergency Alarm/remote start settings.....	16
	7.22 Switch of Electric lock and Vapor lock	16
	7.23 Silent Mode.....	16

7.24. Arm/lock (all lock/unlock functions request the central lock relay box).....	16
7.24.1 Set up arm/lock door by SMS	16
7.24.2. Arm by remote controller	17
7.25 Disarm	17
7.25.1. Disarm by SMS	17
7.25.2 Disarm by remote controller.....	17
7.25.3 Alarm Pause	17
7.26 Find vehicle via remote control	17
7.27 .Remote boot Release	17
7.28 Alerts Function.....	17
7.28.1 SOS Emergency Alarm	17
7.28.2 Geo-fence.....	18
7.28.3 Multi-area management	18
7.28.4.Movement alarm	19
7.28.5. Over Speed Alarm	19
7.28.6 Fuel Checking Alerts(optional)	19
7.28.7 Temperature Checking Alerts (optional)	19
7.28.7.1 Temperature Alert Setting	19
7.28.7.2 Temperature alerts canceling;	19
7.28.7.3 Celsius and Fahrenheit Switch	20
7.28.8 Low battery alarm	20
7.28.9 Power off alarm.....	20
7.28.10. GPS blind Spot alert	20
7.28.11 Accident alarm (Option).....	20
7.29 Alarms under Arm State	20
7.29.1 Door Open Alarm	20
7.29.2 Bonnet alerts	20
7.29.3 Footbrake Alerts	20
7.29.4 ACC alerts.....	21
7.29.5 Shock sensor alerts (Optional).....	21
7.30 Auto Photograph (Optional)	21
7.31 Alerts Resend	21
7.32 Car Trigger Memory/informing	21
7.33 Alarm without GSM network service.....	21
7.34 Cut off the Oil and Power System	21
7.35 Resume the Oil and Power System	21
7.36 Auto-arming	22
7.37 Door closing remind	22
7.38 Park warning	22
7.39 Automatic Central Locking System	22
7.40 Startup appointment (optional)	22
7.40.1 Vehicle type.....	22
7.40.2 Startup appointment of MT vehicles	22
7.40.3 Startup appointment fails.	22
7.40.4 Cancel startup appointment	22
7.41 Start/turn off car remotely	23
7.42 Empty / load.....	23
7.43 Dispatch screen / handset (optional)	23
7.44 LED ads screen (optional).....	23

7.44.1 Add/delete ads	23
7.44.2 Alarm display	23
7.45 RFID (optional)	24
7.46 OBDII/Can (optional)	24
7.46.1 SMS configure how OBD data is sent to Center	24
7.46.2 Request for OBD data by SMS	24
7.46.3 CAN	24
7.47 Check the Vehicle State	24
7.48 Reset by SMS	25
7.49 Sleep Mode	25
7.50 Check IMEI	25
7.51. Set up Terminal (local) Time	25
7.52 TCP/UDP switch	25
7.53 Configure parameters by USB	25
7.54 GPRS Setting	25
7.54.1 APN configuration	25
7.54.2 Configure GPRS User Name and password	26
7.54.3 Configure IP and Port	26
7.55 Less GPRS traffic	26
7.56 Modes Switch between “SMS” and “GPRS”	26
7.57 Set up monitor center number	27
7.58 Web platform and PC installation tracking software user manual	27
8. Cautions	27
9. Faults & solutions	27

1. Function introduction

1.1 This product is a new product based on the GSM / GPRS network and GPS satellites positioning system, which integrates multiple functions of anti-theft alarm, tracking and schedule management. It can track and monitor vehicles via SMS or internet.

1.2 Features

- 1.2.1 GPS / LBS (location based service) double tracking solutions.
- 1.2.2 SMS/GPRS/Internet Network data transmission
- 1.2.3 GPRS on-line and re-connected automatically if GPRS drops
- 1.2.4 SMS / GPRS dual-mode switching
- 1.2.5 Remote configure settings and control tracker
- 1.2.6 Remote start
- 1.2.7 Remote lock
- 1.2.8 Two-way voice communication
- 1.2.9 Voice monitor
- 1.2.10 Snapshot automatically with alarms
- 1.2.11 Fuel measurement, oil theft / leak alarm
- 1.2.12 Temperature detect
- 1.2.13 Data logging
- 1.2.14 Scheduling screen / handheld scheduling equipment
- 1.2.15 LED advertising screen
- 1.2.16 OBD/CAN/RFID

2. Applications

Used widely for tracking and managing vehicle and other moving objects.

3. Interface Schematic



- (JP1) 16PIN harness port
- (JP2) 8PIN harness port
- (JP3) call handheld / scheduling screen port
- (JP4) CAN/OBDII/RFID port
- (JP5) LED advertising screen port
- (JP6) Camera port
- (JP7) 6PIN harness port

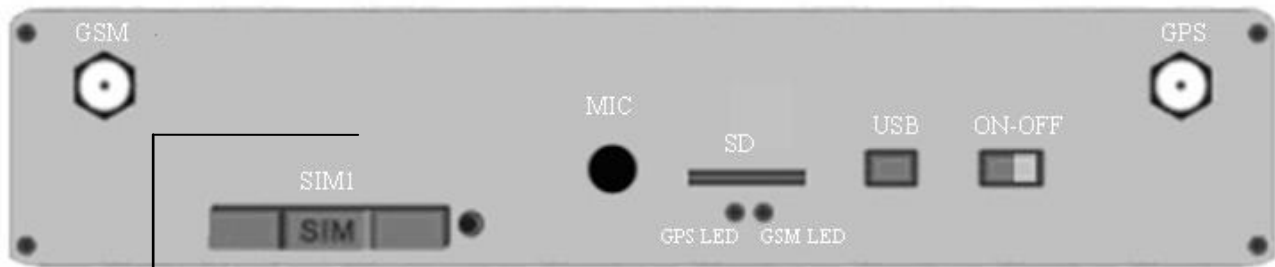



Built-in SIM II

4. Accessories

NO.	PICTURE	NAME	SPECS
1		GPS antenna	3 meters
2		GSM antenna	2 meters
3		Microphone	1.5 meters
4		Harness	16PIN
5		Harness	6PIN
6		Relay	12V/40A
7		Shock sensor	option
8		Siren	option

9		Remote controller	option
10		Dialer	option
11		Voice siren	option
12		Camera	option
13		Temperature sensor	option
14		Fuel sensor	option
15		Central locking relay box (JD01)	option
16		Scheduling screen	option
17		Call handheld	option

18		OBDII/CAN	option
19		RFID	option
20		LED advertising screen	option

5. Specifications

content	Specifications
DIM	110*80*26mm
weight	215g
network	GSM/GPRS
band	850/900/1800/1900Mhz
GPS Module	SIRF3 chip
GPS sensitivity	-159dBm
GPS accuracy	5m
GPS Start time	Cold status 45s Warm status 35s Hot status 1s
Applicable vehicle power	12 V/24V
Backup battery	Chargeable changeable 3.7V 500mAh Li-ion battery
Storage Temp	-40 ℃ to +85 ℃
Operation Temp	-20 ℃ to +65 ℃
Interface	5%--95% non-condensing

6. Installation

6.1 Installation instructions

6.1.1 Please ask the qualified engineers to install.

6.1.2 Do not install it in an environment which is over GSM performance and please fix the antennas in an appropriate position with good reception.

6.1.3 Make sure installation position preventing water and dust.

6.1.4 Find the harnesses in package and insert it into the corresponding holes of the products, and connect the wires to the original car circuit as the installation diagram showing below:

6.1.5 Knowing about the type of the door trigger is positive or negative. Please connect the green wire to the door control circuit if it is positive, and connect blue wire if it is negative.

6.1.6 The default settings for tracker to connect central locking system is electric lock, if vehicle is air compressor lock, please refer to the below descriptions about electric and air compressor lock switch command.

6.1.7 Fuel sensor diagram instructions: Please refer to the fuel sensor installation manual with the fuel sensor.

6.1.8 Connect the GPS and GSM antenna to the right connector, and find an appropriate place to fix the antennas to make sure good reception.

6.2 Installation wiring diagram

6.2.1 Main unit installation wiring diagram

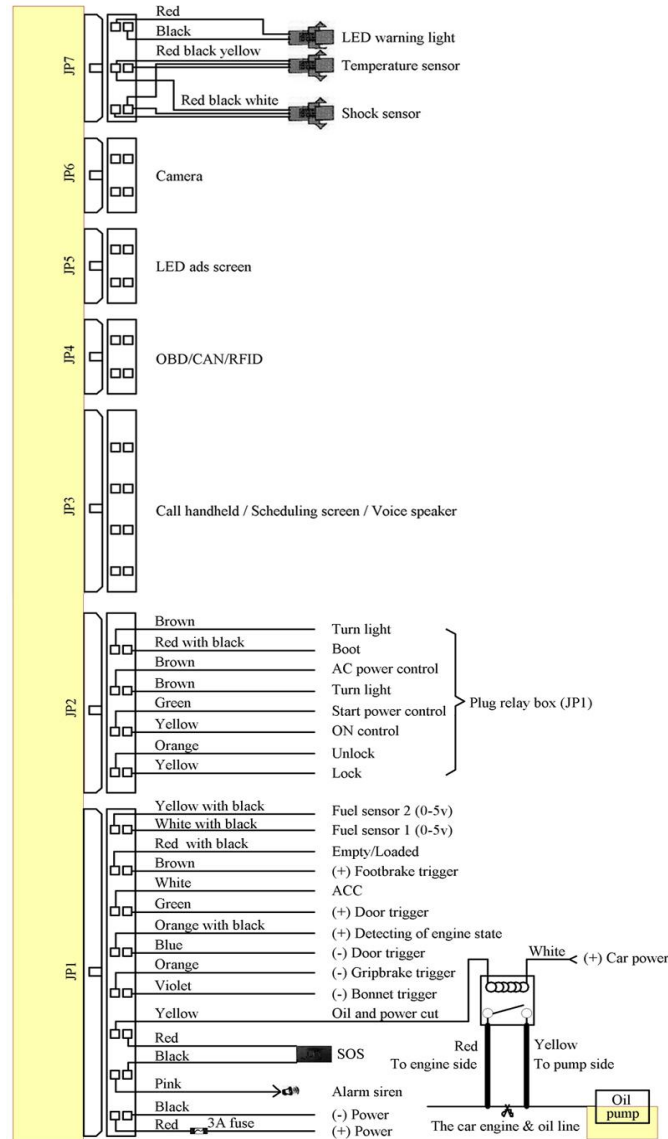

*Orange with black wire of JP1: Engine status detection, it is used to detect the engine started or not after automatically start command, this wire connects to the power wire of fuel pump(for gasoline vehicle) or output wire of generator (for diesel vehicle), and it has 9V-14V voltage after engine started.

6.2.2 Relay box (JD01) wiring diagram

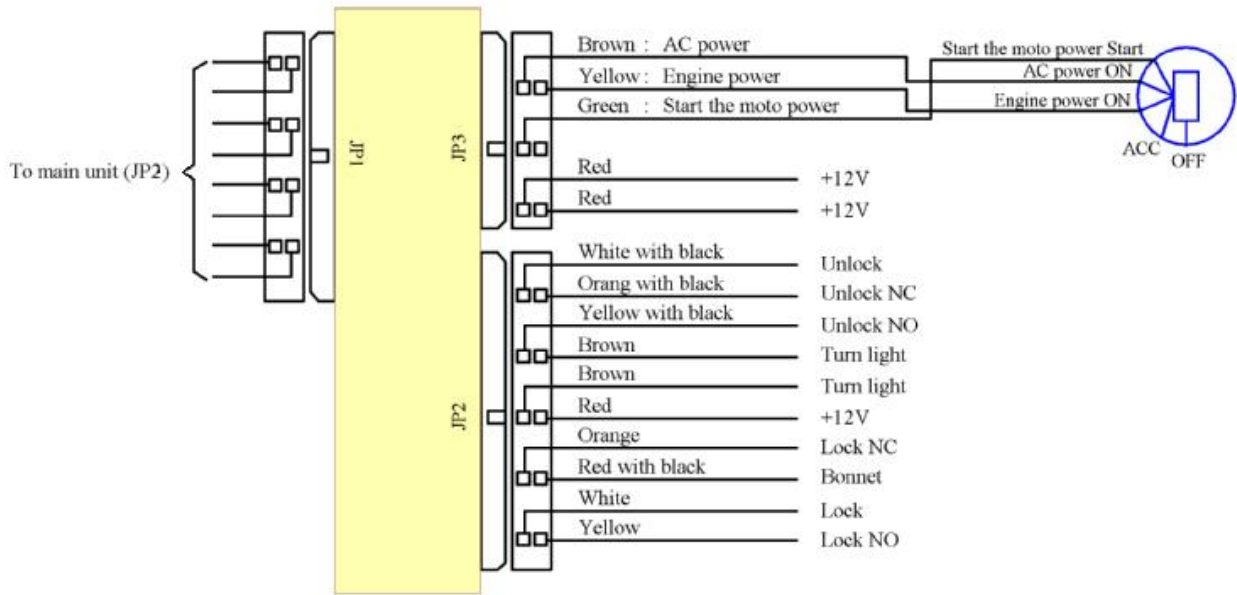

6.2.3 Central locking system wiring diagram

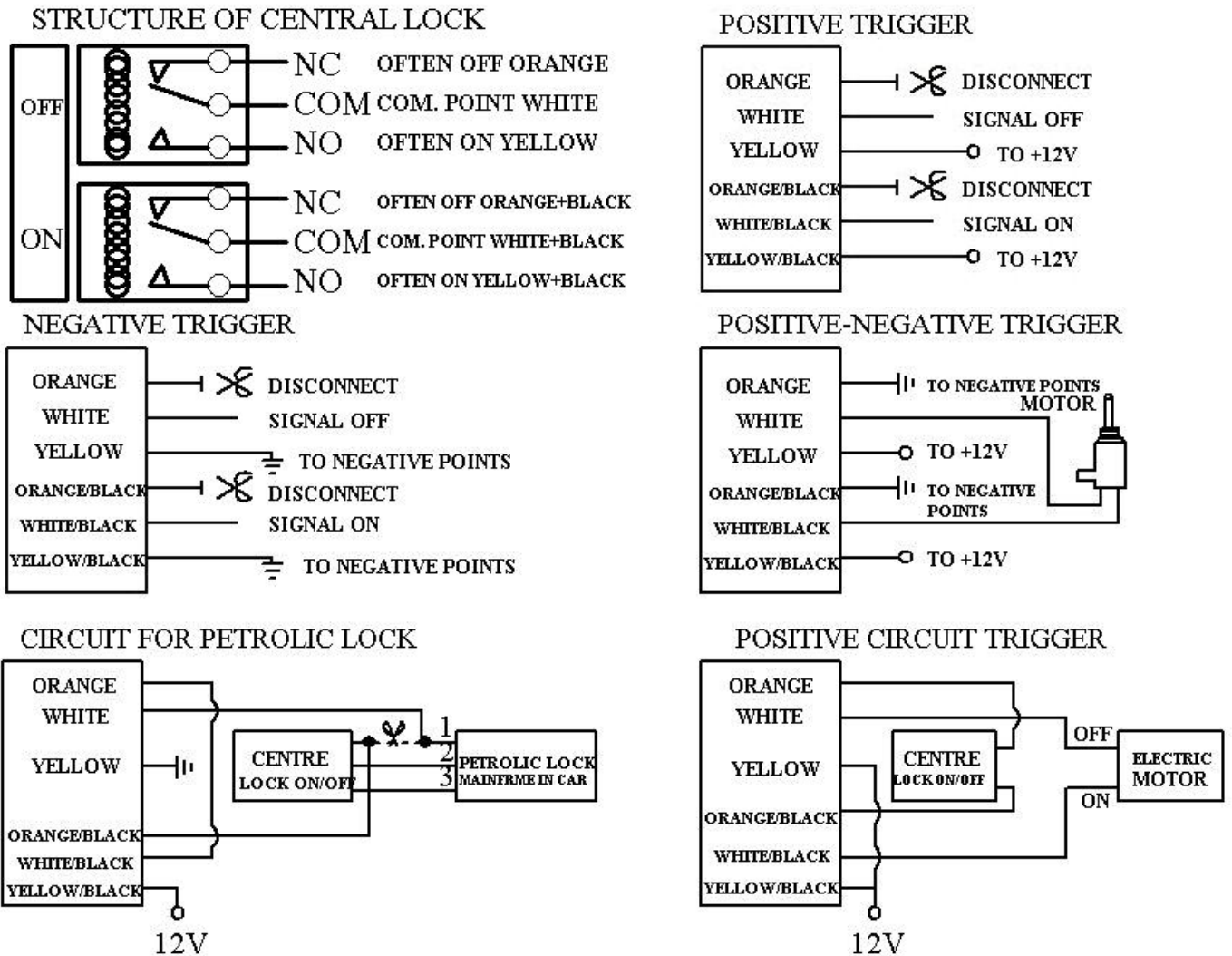

6.3 SIM Installation

6.3.1 Use a tweezers or a sharp thing to touch the SIM CARD popup switch, the SIM CARD slot will pop up, take out the SIM card slot to load the SIM card, and then put the SIM card slot back to its original position after confirm the SIM card in the right place.

6.3.2 The slot of SIM II built in the internal of the tracker, please disassemble the case to install it.

6.3.3 Please make sure that the SIM card is GSM network and able to execute the function of incoming calls display, no calls can be diverted and the PIN code is locked. The SMS format must be TXT format, and can't recognize the PDU format.

6.3.4 If need to save old positions or positions when GSM not available, please insert microSD card to its slot.

7. Function and Operation

7.1 Turn on device

7.1.1 Connect the positive (red) and negative (black) wire to 12V or 24V car power, wait for 1 minute after connecting power to wait tracker works normal, and then turn on the backup battery switch.

7.2 GSM/GPS LED Indicator

LED color	Behavior	Descriptions
Red	NO	No GSM signal
Red	one time per second (fast)	GSM signal normal and work under GSM mode
Red	one time per 3 seconds (slow)	GPRS mode
Green	Quick flash	GPS signal normal
Green	OFF	No GPS signal
Red & Green	Flash three times alternately	Detect microSD card

7.3 Alarming LED indicator

State	LED Behavior
Non-armed state	flash once, stop for 3 seconds.....
Armed state	flash 2 times, stop for 1 second.....
After alarm being triggered	light for 2 seconds, stop for 2 seconds.....
Disarming after being triggered	light for 3 seconds.
After SOS being triggered	flash 3 times in 5 seconds.

7.4 Initialization

Send SMS “begin+password” to the unit, it will reply “begin OK” and initialize all the settings to default factory settings. (default password: 123456)

For example: Send SMS “begin123456”, it will reply “begin ok”. (No quotation marks “” when sending all the SMS)

7.5 Change Password

7.5.1 Send SMS “password+old password+space+new password” to the unit to change the password.

For example: send SMS “password123456 888888” to the unit. If succeeded, “Password ok” will reply to your cell phone.

7.5.2 Keep the new password in mind, the machine will not work properly if lost the password.

7.5.3 Note: The new password must be 6 digits of the Arabic numerals, or the device will not recognize.

7.5.4 Please don't type “+” character in all commands, space means press the space keyboard on cell phone.

7.6 Authorization

There are 5 numbers to be allowed to authorize in the tracker at most.

7.6.1 Call and track the tracker device for 10 times from cell phone in success, it will make the cell phone number as the authorized number automatically, and reply “add master ok”.

7.6.2 Authorization: Send SMS “admin+password+space+cell phone number” to set up an authorized number, the other authorized numbers should be set by the first authorized number, if the number is successfully authorized, the unit will reply “admin ok” by SMS.

7.6.3 Delete authorization: Send SMS“ noadmin+password+space+authorized number” to delete the authorized number.

7.6.4 If you want to track the target when it enters into another country, you must add the country code before the cell phone number, for example, send SMS“admin123456 008613322221111” to the device. Note: 13322221111 will be set up as the authorized number.

7.7 Modes switch “track”, “monitor”& “call”

7.7.1 The default mode is “track” (track mode).

7.7.2 Send SMS command "monitor+password" to tracker device, it will reply " monitor ok!" and switch to monitor mode, and then call the number in device to monitor the voice.

7.7.3 Send SMS command "call+password" to tracker device, it will reply " call ok!" and switch to call mode, and then call the number in device, it will pick up automatically, press the end call button of dial panel to end the call.

7.7.4 Send SMS command "tracker+password" to tracker device, It will reply "tracker ok" and restore to track mode.

7.8 Single Locating

7.8.1 Any number calls the tracker device, it will reply a SMS including the position of latitude and longitude if authorized number has not been set yet. If authorized number has been set successfully, the device won't reply SMS including the positioning of latitude and longitude when the unauthorized number dials it up.

7.8.2 Dialing the tracker device from the authorized number, it will hang up your calling and respond to a real-time latitude and longitude information as following:



**Tracking location, when no GPS signal, the SMS includes the last valid latitude & longitude as well as the LAC code of current position, the LAC code can be input in the column of “manual track” menu of web platform to check the location.

7.9 Auto track continuously

7.9.1 Track with limited times upon time interval:

Send SMS command “fix030s005n +password” to the tracker device, it will report the latitude & longitude at intervals of 30 seconds for 5 times. (s:second, m:minute, h:hour). This command set must be in 3 digits and the maximum value is 255.

7.9.2 Track with unlimited times upon time interval:

Send SMS “fix030s***n+password” to the tracker device, it will reply the latitude & longitude continuously at interval of 30 seconds.

Note: the interval must not less than 20s.

7.9.3 Smart track upon time and distance interval:

7.9.3.1 Please set "track with unlimited times upon time interval" before this function, and send "distance+password+space+distance", tracker will reply "Distance ok", and then tracker will locate upon both the pre-set time and distance.

E.G: Send "distance123456 0050", it means distance is 50 meters; the number must be 4 digits Arabic numbers.

7.9.3.2 Set this function on web server: Set time interval first and then distance interval, tracker will locate upon the time and distance.

7.9.4 Cancel: Send SMS “nofix+password” to the tracker device to cancel the “auto track”.

7.10 Automatic update positions of vehicle turns

7.10.1 The tracker will update the positions automatically to web server once the vehicle changing driving direction over pre set angle value to form a smooth trajectory consistent with the actual road, this function is only effective in GPRS mode.

7.10.2 Send "angle+password+space+angle" to tracker, it will reply" angle ok".

7.10.3 The angle must be 3 digits Arabic numbers, default angle value is 30 degree.

7.11 GPS drift suppression

7.11.1 This function is deactivated as default, send "suppress+password" to tracker, it will reply" suppress drift ok". The GPS data stop updating if vehicle is not driving and latitude and longitude always keep same, and GPS data updates automatically when vehicle is moving (ACC is ON) .

7.11.2 Cancel: send "nosuppress+password" to tracker, it will reply" nosuppress ok ".

7.12 Absolute street address

7.12.1 You must set up the APN of your local GSM network for the SIM card in tracker first before using this function, if there is user name and password for GPRS login, Please refer to below pages to configure the APN, user name and password for GPRS login.

7.12.2 After configure the APN, send “address+password” to device, it will reply SMS including physical street/ address. For example: No.8, Guankou 2nd Rd., Nantou, Nanshan district, Shenzhen, Guangdong, china.

7.13 Location based service (LBS)

When the tracker device doesn't receive valid GPS signals, tracker will locate by location based service(LBS),

the messages includes the GPS coordinates of the last position in SMS mode, but the LAC in message is the current new position, you can also send command “address+password” to tracker to get the newest absolute/physical address and GPS coordinates as well; tracker will automatically switch to track by location based service in GPRS mode, and actualized on the map of web server with LBS mark. And there may be some inaccuracy with actual location by LBS tracking; the bias depends on GSM reception.

7.14 View photos on cell phone

7.14.1 You must set up the APN of your local GSM network for the SIM card in tracker first before using this function, if there is user name and password for GPRS login, Please refer to below pages to configure the APN, user name and password for GPRS login.

7.14.2 After APN configuration, send “photo+password” to device, it will take photos and send a link SMS to authorized cell phone. Click the link, then photo can be viewed on cell phone via Internet.

7.15 Storage

Storage Volume is depends on the capacity of the SD card inserted in the tracker device; it can be copied to computers through card reader.

7.15.1 Auto Storage

When the tracker device lost GSM signals or fall offline from GPRS, tracker will store the tracking position and alerts automatically in the SD card on the basis of the pre-set condition, when GSM signals get back, all the event alerts will be auto-sent to the authorized numbers or monitoring platform (server), but the stored tracking data should be loaded to the monitoring platform via SMS command.

7.15.2 Logging upon times

Send SMS: “save030s005n+password” to the tracker unit, it will reply “save ok”, and will log the lat, long locations every 30 seconds for 5 times. (S: second, m: minute; h: hour).

7.15.3 Multi-logging

Send SMS:”save030s***n+password” to tracker device, it will reply “save ok”.

7.15.4 Logging Clearance

Send SMS: “clear+password” to tracker device, it will reply “clear ok”.

7.16 Data Load

7.16.1 Current date Load: Send SMS: “load+ password” to tracker device, it will reply: “load ok” if the device is working well under GPRS mode; if not, it will reply “load fail! Please check gprs” that means device does not work under GPRS mode.

7.16.2 Specified date Load: Send SMS: “load+ password+ space+ year month date” to tracker device, it will reply: “load ok” and load the tracking data to the monitoring platform upon the valid time you choose. For Example: send SMS: “load123456 20110425” to the tracker device, means to load the tracking data of 25th April 2011 to monitoring platform.

7.17 Forward the third parties’ message

7.17.1 Send SMS "forward+password+space+third parties phone number" from authorized phone number, tracker will reply"forward ok", and supports 1 third parties phone numbers at most.

For example, set the phone number of the service provider of the simcard in the tracker, when charge remind message coming in, tracker will forward it to authorized phone number.

7.17.2 Cancel: Send SMS command "noforward+password".

7.18 Charges Inquiry

Send SMS command "balance+password+space+carrier's phone number+space+code" to tracker, it will forward the code to carrier's phone number and return the balance message received from carrier's phone number.

7.19 ACC working alarm

7.19.1 This function is disabled as default. To active this functions, send "ACC+password" to tracker, it will reply"ACC ok". And tracker will send "ACC on+latitude & longitude" to authorized numbers when detect ignition action, that means the vehicle has been started; and tracker will send "ACC off+latitude & longitude" to authorized numbers, that means vehicle stop working.

7.19.9.2 Send "noACC+password" to disabled this function, tracker will reply "noACC ok".

7.19.9.3 This configuration can only enable and disable the alarm to authorized numbers; it will send to web server automatically in GPRS mode and can't be disabled.

7.20 Dialer (Optional)

7.20.1 Picture of Dialer

0—9 * # Phone button

YES Dial the phone

C Delete the last number

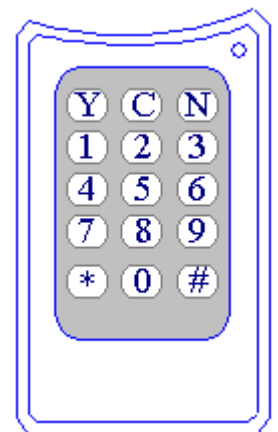

NO Delete exit number / Hang up

Press 0-9 the user can hear the number he dialed, with toot by press other buttons, also the indicator of dialer will blink one time.



7.20.2 Dialer and remote controller program





Keep stepping on foot brake, short press SOS button for 7 times, the siren will beep one time, turn light will flash for one time to enter programming mode, then press button"1", meanwhile siren beeps 3 times, program succeed.

1. Short press  of the first remote controller, the turn light flash for one time and the siren beep one time, that means first remote controller program succeed.
2. Short press  of the second remote controller, the turn light flash for 2 times and the siren beep 2 times, that means the second remote controller program succeed.
3. Short press "0" button of the dialer, the turn light flash for 3 times and the siren beep 3 times, that means dialer program succeed.
4. Loosen the foot brake, quit programming mode and save automatically.

7.20.3 .Dial a Phone

Enter the phone number which needs to dial, press “YES” to call out, press “NO” to hang up the phone.

7.21 Remote controller (optional)

Button	Function	Descriptions
	ARM/LOCK	Press for 0.5 second, the siren will beep one time.
	Deterrence/car search	Press for 0.5 second when it is in arm state, siren will beep 10 seconds
	DISARM & UNLOCK	Press for 0.5 second when it is in arm state, the siren will beep two times.
	Open vehicle boot	Press for 2 seconds in disarm mode, vehicle boot will be open.
	SOS/start engine remotely	Press for 3 seconds, Tracker will send SOS alert to authorized phone numbers without voice or start your car engine, it is set by yourself

7.21.1 SOS Emergency Alarm/remote start settings

7.21.1.1  is for SOS as default settings.

7.21.1.2 Send SMS “startkey+password+ start” to the tracker device, it will reply “startkey start ok!”

When Long press  button, car engine will be started remotely.

7.21.1.3 Send SMS “startkey+password+ sos” to the tracker device, it will reply “startkey SOS ok!”

When Long press  button, SOS emergency alarm will be triggered.

7.22 Switch of Electric lock and Vapor lock

Send SMS command “locktype+password+ space+1” to the tracker, it will reply“Vapor lock ok!”
Tracker device will switch to Vapor lock.

Send SMS command “locktype+password+ space+0” to the tracker, it will reply“Electric lock ok!”
Tracker device will switch to electric lock.

7.23 Silent Mode

Send SMS “silent+password” to tracker device, it will reply “silent ok!” .It means tracker device enters into silent mode, no action from siren after alarm is triggered, but tracker will send alarm SMS to authorized numbers.

Quit silent mode , Send SMS “loud+password” to tracker device, it will reply “ loud ok!”. It means tracker quit from silent mode, siren will sound after alarm is triggered, and tracker will also send SMS alarm to authorized numbers.

7.24.Arm/lock (all lock/unlock functions request the central lock relay box)

7.24.1 Set up arm/lock door by SMS

Send SMS command “ arm+password” to the tracker, the terminal of vehicles will enter the arm state, Meanwhile ,car door is locked, and it will reply SMS “Tracker is activated”.

If the vehicle are in ignition state (ACC is ON), car door will be locked, but ARM will fail, Meanwhile , it will reply SMS “ set up fail! pls turn off ACC” .

If ACC is off, but door is not closed, tracker cannot set the arm state, and it will reply “ set up fail! pls close the door”.

7.24.2. Arm by remote controller

In disarm mode, short-press remote control button ,the door of the vehicle will lock, it enter sound and light arm states, siren beeps one time, turn light blink one time, no SMS message.

If the vehicles are in ignition state (ACC is ON), fail to set arm state, but door will be locked, siren will not beep. If car door is not closed, siren will beep for 3 times with turn light flashing.

7.25 Disarm

7.25.1. Disarm by SMS

Send SMS command "disarm+password" to the tracker device in the vehicle, It will reply “Tracker is deactivated” in both armed and disarmed state, and the SMS command will make the tracker device enter into disarmed state if the unit currently armed.

It won't alarm if the door is open and sensor is vibrated and the engine is started when deactivated this arm function.

7.25.2 Disarm by remote controller

During arm mode, short press  button, vehicles go to disarm state , siren will beep for 2 times, turn light fashes for 2 times.

7.25.3 Alarm Pause

When alarm is triggered, press  button to stop siren and turn light, but the alarm system is in the arm state, Then, not lock door or unlock door.

7.26 Find vehicle via remote control

During arm mode, short-press  button 1 time, Siren will beep for 10 seconds with turn light flashing , press any button to stop.

7.27 .Remote boot Release

Long-press  button for 2 seconds in disarm mode, vehicle trunk will be open.

7.28 Alerts Function

7.28.1 SOS Emergency Alarm

7.28.1.1 SOS via Remote Control

Long-press  button for 3 seconds to ask for help, without any action from siren or turn light, the device will send sms: “help me + lat/long” to every authorized no. in 3 minutes interval. Alerts will stop after you reply sms: “help me!” to the device by any authorized no.

7.28.1.2 SOS via SOS button

Long-press SOS button for 2 seconds, the device will send sms: “help me + lat/long” to every authorized no. without any action from siren or turn light. Alerts will stop after you reply sms: “help me!” to the device by any authorized no.

7.28.2 Geo-fence

Set up a geo-fence for the tracker device to restrict its movements within a district. The unit will send SMS to the authorized numbers when it goes out of this district.

Set up: When the tracker stays immobile in a place for 3-10 minutes, the user can send SMS “stockade+password+space+latitude,longitude;latitude,longitude” to tracker to set the restricted district. In case of breach, it will send SMS “stockade!+latitude/longitude.” to the authorized numbers.

Note: The first latitude & longitude is coordinate of the top left corner of the Geo-fence, while the second latitude & longitude is the coordinate of the bottom right corner, it will alarm SMS in 3 minutes interval.

Cancel: Send SMS “nostockade+password” to deactivate this function

7.28.3 Multi-area management

7.28.3.1. Set Area

Send SMS command "area+password+space+latitude,longitude+space+areaname,distanceM" to tracker(distance unit: M for meter, K for kilometer), it will reply "area01 ok".

Example: Send "area123456 22.353648,113.543678 school,800M".

Note: 5 areas at most and the distance between two points can't be less than the total distance in the 2 commands, and different areas can't cover each other.

7.28.3.2 Delete areas

Send SMS command:"noarea+password+space+area name", tracker will reply:"noarea ok".

7.28.3.3 Rename and set distance

Send SMS command "rename+password+space+old name;new name,distanceM" to tracker, if name is not repeated and area doesn't cover others, it will reply "rename ok!" for successful configuration.

Example: Send"rename123456 area01;school,800M", it means the new area name is "school", and covers area of a radius of 800 meters.

7.28.3.4 Activate multi-area management

Send SMS command "area+password+space+on" to tracker, it will reply "Area on ok!", when tracker enter the pre set area, it will send SMS "area name+latitude & longitude" to all the authorized phone number, and send same SMS when goes out of the area.

7.28.3.5 Deactivate Multi-area management

Send SMS command "area+password+space+off" to tracker, it will reply"area off ok!"

7.28.4.Movement alarm

7.28.4.1.Set up: when the unit stays immobile in a place for 3-10 minutes with GPS signal reception, the user can send SMS“move+password+space+0200” to the tracker (Suppose area of a radius of 200 meters, it supports 4 digits at most. Unit: Meter). It will reply “move OK”. In case of such a movement (the default distance is 200m), it will send SMS “Move+ latitude & longitude” to the authorized numbers at interval of 3 minutes.

7.28.4.2 Cancel: Send SMS “nomove+password” to deactivate the movement alarm.

7.28.5. Over Speed Alarm

Set up: Send SMS “speed+password+space+080” to the tracker. (Suppose the speed is 80km/h), and it will reply “speed ok!” When the tracker moves exceeding 80km/h, the tracker will send SMS “speed+080!+latitude/longitude” to the authorized numbers in 3 minutes interval.

Cancel: Send SMS “nospeed+password” to deactivate the overspeed alarm.

Remark: The recommended speed should be not less than 30km/h. For below that rate, it will be effected the accuracy by GPS signals drift etc.

7.28.6 Fuel Checking Alerts(optional)

During driving process, when the Tracker Device detects the fuel decrease by 20% in 3 minutes, then it will send oil leak or theft alert “oil:XX%+Lat, Long” to authorized number in 3 minutes interval. Siren beeps 30 seconds continuously.

When Acc off and Car stop, the tracker device detects the fuel decrease 2% comparing with pervious fuel when car stop, It will send oil leak or theft alert “oil: XX%+ Lat, Long” to authorized number in 3 minutes interval. Siren beeps 30 seconds continuously with turn light flashing.

Cancel fuel alarm: Send SMS command “nooil+password” to tracker.

7.28.7 Temperature Checking Alerts (optional)

The available temperature range is from -050°C to $+125^{\circ}\text{C}$, the number should be 3 digits and temperature unit must be in upper case in SMS command

7.28.7.1 Temperature Alert Setting

Send SMS command “temperature+password+space+***C, ***C”to the tracker, it will reply “temperature ok” .When the temperature is beyond the limited range, the tracker will send SMS alarm to the authorized numbers in 3 minutes interval.

For example: Send SMS “temperature123456 -020C,060C” ,when the temperature is below -20°C or above 60°C ,the tracker will send SMS alarm to the authorized numbers in 3 minutes interval. With siren beeps 30 seconds with turn light flashing.

7.28.7.2 Temperature alerts canceling;

Send SMS command “notemperature+password” to tracker, it will reply “notemperature OK”

7.28.7.3 Celsius and Fahrenheit Switch

Switch between Celsius and Fahrenheit .The default temperature unit is Celsius, in the sms commend C = °C F= °F

7.28.8 Low battery alarm

7.28.8.1 Send SMS “lowbattery+password+space+on”, it will send SMS “low battery+latitude/longitude” to authorized numbers 2 times in total **in 15 minutes interval** when voltage of battery is going to be about 3.55V.

7.28.8.2 This function activates as default, send SMS “lowbattery+password+space+off” to deactivate.

7.28.9 Power off alarm

7.28.9.1 Send “ extpower+password+space+on” to activate, it will send SMS “power alarm+latitude/longitude” to authorized numbers every 3 minutes when external power is cut off.

7.28.9.2 This function activates as default.

Cancel: Send SMS “ extpower+password+space+off” to deactivate it.

7.28.10. GPS blind Spot alert

7.28.10.1 This function deactivates as default, send SMS “gpssignal+password+space+on”, it will send alert SMS “no gps+last valid latitude/longitude before lost signal”

7.28.10.2 Send SMS “gpssignal+password+space+off” to deactivate.

7.28.11 Accident alarm (Option)

When tracker detects accident occurred (severe impact) during normal driving, it will send “Accident! + latitude & longitude ” to all authorized phone numbers.

7.28.11.2 This function is active as default. To disable this functions, send "Accident+password+space+off" to tracker,

7.28.13. send "Accident+password+space+on" to tracker, when need to active this function again.

7.29 Alarms under Arm State

7.29.1 Door Open Alarm

When the door open during arm mode, the device will send sms “door alarm +lat/long” to Authorized no. in 3 minutes interval; Siren beeps 30 seconds continuously with turn light flashing. Disarm the device to stop.

7.29.2 Bonnet alerts

When open bonnet during arm mode, the device will send “bonnet alarm+lat/long” to Authorized no. in 3 minutes interval; siren beeps 30 minutes continuously with turn light flashing. Disarm the device to stop.

7.29.3 Footbrake Alerts

When step footbrake during arm mode, device will send “footbrake alarm+lat/long” to authorized no. in 3 minutes interval; siren will beeps 30 seconds continuously with turn light flashing. Disarm the device to stop.

7.29.4 ACC alerts

when the key turn to ACC On position/ any ACC Action /Car Acc on during arm mode, the device will send SMS:”ACC alarm+lat/long” to authorized no in 3 minutes interval; siren beeps 30 seconds with turn light flashing. Disarm the device to stop.

7.29.5 Shock sensor alerts (Optional)

When shock sensor be trigged during arm mode, device will send sms”sensor alarm+lat/long” to authorized no. in 3 minutes interval; Siren beeps for 5 seconds if shock sensor alarm is triggered one time in 15 seconds and beeps for 30 seconds if it is triggered two times in 15 seconds with turn light flashing at same time, Disarm the device to stop.

7.30 Auto Photograph (Optional)

When the tracker terminal device detects DOOR/ ACC / SOS / alarm, the tracker device will be automatically ready for photo during sending the alarm and then shoot camera to upload the photo to the monitoring platform (web server).Meanwhile, the device will send link SMS to all authorized cell phone numbers, then photos can be viewed on cell phone . Meanwhile all these photos will be automatically saved in the SD card, and viewed after copied to computers through card reader.

7.31 Alerts Resend

Siren beeps in Non-quiet mode if DOOR/SHOCK SENSOR/ACC, OIL alarms are triggered during gsm blind areas, and these alarms will be stored and send to authorized numbers or web server after GSM signal recover.

7.32 Car Trigger Memory/informing

When open the door after door alert deactivated, siren beeps one time with 3seconds alarm indicator on that means the vehicle has been triggered.

7.33 Alarm without GSM network service

When the car is in the place without GSM network service, siren will be sound under non-silent mode if alarm is triggered (door, sensor, ACC), no SMS alarm will be sent to authorized number.

7.34 Cut off the Oil and Power System

7.34.1 Send command “stop+password” to tracker, tracker will execute it and reply “Stop engine Succeed”. And it will remain immobile state until next command to resume.

7.34.2 Stop mode

7.34.2.1 Execute immediately: Send command “quickstop+password” to tracker, it will reply “quickstop OK”. Then tracker will stop the car immediately after “stop” command.

7.34.2.2 Execute depends on speed(Default mode): Send command “noquickstop+password” to tracker, It will reply “noquickstop OK”, Then the tracker won’t stop the car immediately after “stop” command, instead, it will reply “it will be executed after speed less than 20KM/H”, and stop the car when the speed is less than 20KM/H.

7.35 Resume the Oil and Power System

Send “resume+password” to tracker, it will reply "Resume engine succeed", that means vehicle has resume the oil supply.

7.36 Auto-arming

After stop the car and close the door, within one minute, if no arm action, anti-theft system automatically close the door and enter into arm status

Auto-arming function is deactivated in default. Send SMS “auto arming+password” to activate it . And re-send the same command to deactivate it.



7.37 Door closing remind

Door closed improperly during arm mode, siren beeps 3 times with turn light flashing to remind.

7.38 Park warning

When ACC is off and door is open, turn light will flash, informing cars behind. Press any button to stop it.

7.39 Automatic Central Locking System

When Vehicle is on (step on footbrake and turn on ACC), step on the footbrake to lock the door automatically, during driving process, press  Button to lock or press  button to unlock the door.

7.40 Startup appointment (optional)

To auto start the manual transmission vehicle, the car should be started in advance when parking . Otherwise , the vehicle cannot be auto started .

7.40.1 Vehicle type

Manual-transmission vehicles need be started in advance.

Send sms “ Cartype+password+space+hand” , gps device will reply “ cartype hand ok !” . Vehicle is manual transmission (MT) type.

Send sms “ Cartype+password+space+auto” , gps device will reply “ cartype auto ok !” . Vehicle is auto transmission (AT) type.

7.40.2 Startup appointment of MT vehicles

- 1). When parking, the gear shift should be pushed to Neutral gear before ACC is off .
- 2). Pull the handbrake, release the foot brake.
- 3). the vehicle will stay mobile state for 2 minutes, and then pull out the key to turn off the engine.
- 4). After turn off engine, open door and close door, Turn light flashes 2 times. Startup appointment succeeds.

7.40.3 Startup appointment fails.

- 1). Within 2 minutes, engine is off. Startup appointment fails.
- 2). When pulling out the key, the footbrake is not released. Startup appointment fails.

7.40.4 Cancel startup appointment

- 1). Push footbrake and pull out key to stop engine .Startup appointment will be not activated.

- 2). Open car door or turn on engine can cancel startup appointment.
- 3). Send door open alert or ACC alert can cancel startup appointment.

7.41 Start/turn off car remotely

7.41.1 start/turn off car remotely by remote controller

Long press  button on remote controller, the car will start in 2 seconds.

Prerequisites are: The key is not placed “On”, MT vehicle startup appointment succeeds, AT vehicles are on P or N gear (the handbrake should be pulled up)

Results: The siren and turn light act one time if succeeds. The siren and turn light act 2 times if not succeed for 3 times. When it is in arm state, after start car remotely, it still remains arm state. Before loading, driver should switch vehicle to “disarm “state by turning key to “On “place (Attention: artificial ignition is forbidden. Footbrake should be pushed one time before driving). When the engine turns on for more than 10 minutes and key is not pushed to “On “place, engine will automatically turn off. After starting remotely succeeds, long press , the car will turn off.

7.41.2 Start / turn off car remotely by sms

Send sms“carstart+password”, gps device replies “now start the car!” and starts the car remotely. Send it again to turn off car and “flameout ok!” will be replied.

7.42 Empty / load

In case of people getting on / off car, gps device will send sms to monitor center.

7.43 Dispatch screen / handset (optional)

Dispatch screen and handset share the same interface. Please refer to dispatch screen/handset user manual.

Main features are:

1. Make/receive phone calls.
2. Adjust volume.
3. Display gps information, e.g. lat/long, speed etc.
4. Receive and display monitor center news.
5. Phone call dispatch.

7.44 LED ads screen (optional)

7.44.1 Add/delete ads

Ads news from monitor center will be transmitted to LED screen automatically. LED screen can store 100 ads information. Ads can be deleted by central management.

7.44.2 Alarm display

In the case of SOS emergency, “SOS!” will flash quickly on LED screen. Alarm display will be cancelled by disarm or cancel alarm after alarm is stopped and LED screen will resume to display ads.

7.45 RFID (optional)

RFID module is supported. RFID data can be uploaded to service center via GPRS. Service center will display And record RFID data.

7.46 OBDII/Can (optional)

7.46.1 SMS configure how OBD data is sent to Center

Send sms command “Obdii+password+space+0” to gps device, OBD data will be turned off.

Send sms command “Obdii+password+space+1” to gps device, OBD data will be sent both when multi tracking and single tracking.

Send sms command “Obdii+password+space+2” to gps device, OBD data will only be sent when single tracking. (Default mode)

7.46.2 Request for OBD data by SMS

Send sms command “Obdmsg+password” to gps device, below information will be returned:

T: 05/21/13 15:25:50

ODO:	Accumulative mileage
IF:	Instant fuel
AF:	Average Fuel
Dtime:	Driving time
speed:	Speed
Pload:	Power load
TEMP:	Water temperature
Throttle:	Throttle percentage
Espeed:	Engine speed
BAT	battery voltage
DTC	diagnostic trouble code

7.46.3 CAN

It depends on the specific car type.

7.47 Check the Vehicle State

Send SMS command “check+password” to the tracker device in the vehicle, It will reply the status of external power, battery, GPS reception, GPRS,ACC, door, GSM reception and oil consumption, temperature to the authorized numbers.

For example: Send SMS “check123456” to the tracker device in the vehicle, it will reply following SMS after executed the command.

Power: ON Battery : 100%

Door : OFF ACC :ON

GPS : OK

GPRS: OFF line

GSM Signal: 21 (1-32) the higher digit it shows; the stronger of GSM reception it receives.

Oil: 65.5% 65.7 Temperature: +32.0

7.48 Reset by SMS

Send SMS “reset+password” to tracker device to reset the GSM module and GPS module of the tracker device, it will reply “reset ok”

7.49 Sleep Mode

6.31.1 This function is deactivated as default, send “sleep+password+space+on”, tracker will reply “sleep on ok”. When vehicle is not driving (ACC is OFF), GSM module fall asleep; GPS module shut off; and tracker works in low power consumption. Calling, SMS command and any triggered alarm can awake it.

6.31.2 Cancel: Send “sleep+password+space+off”, tracker will reply “sleep off ok”, then tracker won't sleep, GSM and GPS works all the time.

7.50 Check IMEI

Send SMS command "imei+password" to the unit. E.g. Send SMS command "imei123456" to the tracker device, an IMEI number in 15 digits will reply to your cell phone.

7.51. Set up Terminal (local) Time

7.51.1 Send SMS command “time+space+zone+password+space+time” to the tracker unit, If succeed, It will reply “time OK”

7.51.2 For example: Send SMS “time zone123456 8”, 8 is Chinese time zone, If your country time zone is minus, send SMS “time zone123456 -8”.

7.52 TCP/UDP switch

Send command: "gprs+password,0,0" switch back to TCP mode, this is the default mode.

Second command:"gprs+password,1,1" switch to UDP mode.

7.53 Configure parameters by USB

Copy the Serial debugging tool (SSCOM.EXE) to computer, connect the tracker with computer and open serial debugging tool with the USB cable (optional parts), then choose correct COM port, baud rate is 19200, send serial port command (Tick "send new " on SSCOM interface): \$SET GT PARA, tracker will return the sample format of the command, send appropriate commands according to the sample format of command. Tracker will return "ok" after succeeding in configuring to indicate successful configuration. For detailed operations, please check “COM PORT COMMAND USER MANUAL”

7.54 GPRS Setting

User must send SMS via cell phone to set up APN, IP and port before starting tracking by GPRS

7.54.1 APN configuration

APN is short for Access Point Name and differs from country to country. For more information about your local APN, please inquire with your local GPRS network operator.

7.54.1.1 APN settings of the first SIM card: (External SIM card is the first SIM card)

Send SMS “APNONE+password+Space+your local APN” via a cell phone and if succeeded, the tracker will return the message “APN OK”.

7.54.1.2 APN settings of the second SIM card: (Internal SIM card is the second SIM card)

Send SMS “APNTWO+password+Space+your local APN” via a cell phone and if succeeded, the tracker will reply “APN OK”

7.54.1.3 E.g. Send SMS command “APNONE123456 CMNET”. If succeeded, tracker will reply “APN OK”

Notes: 123456 refer to password of tracker and CMNET is the APN of the china mobile

7.54.2 Configure GPRS User Name and password

7.54.2.1 In most countries, the user name and password involving GPRS login are not compulsorily necessary, therefore, the entry can be skipped. For those countries requiring user name and password, please configure as following:

7.54.2.2 User name and password settings of the first SIM card

Send SMS “upone+password+space+user+space+password”If succeeded, tracker will reply “user,password ok! ”

7.54.2.3 User name and password settings of the second SIM card

Send SMS “uptwo+password+space+user+space+password”If succeeded, tracker will reply “user,password ok!

7.54.2.4 For instance, send SMS “upone123456 jonnes 666666” to the tracker, and if succeeded, tracker will reply “user, password OK”

Note: 123456 is tracker device password, jonnes is the user name for GPRS login, 666666 is the password for GPRS login.

7.54.3 Configure IP and Port

7.54.3.1 Send SMS as below via a cell phone: adminip+password+Space+IPAddress+Space+Port Number. If succeeded, “adminip OK” is returned by the device in SMS.

7.54.3.2 E.g. Send SMS command “adminip123456 202.104.150.75 9000” to the tracker device, If succeeded, “adminip OK” is returned by the device in SMS. (123456 is default password, 202.104.150.75 is IP, 9000 is port)

7.55 Less GPRS traffic

7.55.1 Tracker will change to less GPRS traffic mode after parking 5 minutes (ACC is OFF), GPRS disconnect and connect again when alarm being triggered or vehicle starts driving.

7.55.2 Activate this function: Send "less gprs123456 on", tracker will reply "less gprs on ok".

7.55.3 Deactivate this function: Send "less gprs123456 off", tracker will reply" less gprs off ok".

7.56 Modes Switch between “SMS” and “GPRS”

7.56.1 The default mode is “SMS”

7.56.2 Send SMS “GPRS+password” to the unit, and it will reply “GPRS ok!” it means tracker device has switched to “GPRS” mode.

7.56.3 Send SMS “SMS+password” to the unit, it will reply “SMS ok!” and restore to “SMS” mode.

7.57 Set up monitor center number

7.57.1 Setup: send command “centernum+password+space+number” to tracker, it will reply “center num ok”. After setup monitor center number, the messages of auto track by sms will be set to this center number, if all alarms need to be sent to this number too, then this center number must be setup as authorized number.

7.57.2 Cancel: Send “nocenternum+password” to tracker, it will reply “no center num ok”

7.58 Web platform and PC installation tracking software user manual

7.58.1 Web based platform www.gpstrackerxy.com. Configuration IP: 202.104.150.75 Port: 9000. Please check “software platform user manual” included in the CD for detailed operation information.

7.1.2 PC based installation tracking software user manual included in the CD in package.

8. Cautions

Please comply with the instructions to extend the unit life:

1. Keep the unit dry. Any liquid, i.e. rain, moisture, may destroy or damage the inside circuitry.
2. Don't use & store the unit in dusty places.
3. Don't put the unit in overheated or overcooled places.
4. Handle carefully. Don't vibrate or shake it violently.
5. Clear the unit with a piece of dry cloth. Don't clean in chemicals, detergent.
6. Don't paint the unit, this may cause some foreign materials left in between the parts.
7. Don't disassemble or refit the unit.
8. Please read the user manual carefully before installation and operation, learn something more about the voltage range. Otherwise, it won't work properly or destroy the product.

Please check “software platform user manual” included in the CD for detailed operation information.

9. Faults & solutions

Faults	Solutions
Startup Fail	Please check out the power wiring in correct place.
Call Fail	Check the GSM antenna connected. Check whether the SIM card in place. Check whether the normal power supply voltage
No GPS signal	Check the GPS antenna connected.
SMS reply fail	Check the password and the sms commands.
Hang up Fail	In existence of an authorized number, an unauthorized number dials up the unit. Please initialize the unit and re-setup the authorized numbers.
Stop engine fail	Check the relay for engine cut is right connected.

central lock fail	Check if the external cable is connected well according to Wiring diagram
Remote Controller , Dial panel fail	Remove external power , turn on the device and program again
Siren fail	Siren's voltage is DC12V/24V/1A. Siren can't be activated if it is negative triggered.