



sirius

SOFT STARTERS



3RW40
3RW44



SIEMENS

Global network of innovation

SIEMENS Distributor:

Easycom Automation Co.

Tel: +86-20-38473560 Fax: +86-20-38473550

Add. Hubiao Sq, Tianhe, Guangzhou, China

Email: info@gzeasycom.com

<http://www.gzeasycom.com>

Reduced Voltage Electronic Soft Starts

3



Catalog

	SIRIUS soft starters
3/2	Introduction
3/3	General data
	<u>For standard applications</u>
	SIRIUS 3RW40 soft starters
3/4	- Overview
3/4	- Application
3/4	- Selection and ordering data
3/5	- Accessories
	<u>For High Feature applications</u>
	SIRIUS 3RW44 soft starters
3/6	- Overview
3/6	- Application
3/7	- Selection and ordering data
3/9	- Accessories

Technical information

	SIRIUS soft starters
	<u>For standard applications</u>
3/10	SIRIUS 3RW40 soft starters
3/10	- Function
3/11	- Technical specifications
3/15	- Characteristic curves
3/15	- Dimensional drawings
3/16	- Schematics
3/17	- More information
	<u>For High Feature applications</u>
	SIRIUS 3RW44 soft starters
3/18	- Function
3/19	- Technical specifications
3/27	- Characteristic curves
3/27	- Dimensional drawings
3/28	- Schematics
3/32	- More information



SIRIUS Soft Starters

Introduction

Overview

3

Products at a glance



3RW30/3RW31



3RW40



3RW44

SIRIUS soft starters

for standard applications

SIRIUS 3RW30 soft starters

- SIRIUS 3RW30/31 soft starters for soft starting and smooth ramp-down of three-phase asynchronous motors
- Rating range of up to 60 Hp at 460 V (50 °C ambient)
- Application areas:
 - Fans
 - Pumps
 - Building/construction machines
 - Presses
 - Escalators
 - Transport systems
 - Air conditioning systems
 - Ventilators
 - Assembly lines
 - Compressors and coolers
 - Operating mechanisms

Order No.	Page
-----------	------

3RW30, 3RW31	See Industrial Controls catalog
--------------	---------------------------------

SIRIUS 3RW40 soft starters

- SIRIUS 3RW40 soft starters with integrated functions
 - solid-state motor overload and intrinsic device protection and
 - adjustable current limiting
 for the soft starting and stopping of three-phase asynchronous motors
- Rating range from 75 to 300 Hp at 460 V (50 °C ambient)
- Application areas:
 - Fans
 - Pumps
 - Building/construction machines
 - Presses
 - Escalators
 - Transport systems
 - Air conditioning systems
 - Ventilators
 - Assembly lines
 - Compressors and coolers
 - Operating mechanisms

3RW40	3/4
-------	-----

for High Feature applications

SIRIUS 3RW44 soft starters

- In addition to soft starting and soft ramp-down, the solid-state SIRIUS 3RW44 soft starters provide numerous functions for higher-level requirements
- Rating range
 - up to 900 Hp (at 460 V)¹⁾ in inline circuit
- Application areas
 - Pumps
 - Ventilators
 - Compressors
 - Cooling systems
 - Industrial refrigerating systems
 - Water transport
 - Conveying systems
 - Hydraulics
 - Machine tools
 - Mills

3RW44	3/6
-------	-----

1) After phase two release, 1st quarter 2006.

Overview

The advantages of the SIRIUS soft starters at a glance:

- Soft starting and soft stop¹⁾
- Stepless starting
- Reduction of current peaks
- Avoidance of mains voltage fluctuations during starting
- Reduced load on the power supply network

- Reduction of the mechanical load in the operating mechanism
- Considerable space savings and reduced wiring compared with mechanical reduced voltage starters
- Maintenance-free switching
- Very easy handling
- Fits perfectly in the SIRIUS modular system



		SIRIUS 3RW30/31 Standard applications	SIRIUS 3RW40	SIRIUS 3RW44 High Feature applications
Rated current at 50 °C	A	2.6 ... 85	117 ... 385	26 ... 1051
Rated operating voltage	V	200 ... 575	200 ... 600	200 ... 690
Motor rating at 460 V				
• Inline circuit	Hp	1.1 ... 60	75 ... 300	15 ... 950
• Inside-delta circuit	Hp	—	—	22 ... 600
Temperature range	°C	-25 ... +60	-25 ... +60	0 ... +60
Soft starting/ramp-down		✓ ¹⁾	✓	✓
Voltage ramp		✓	✓	✓
Starting/stopping voltage	%	40 ... 100	40 ... 100	20 ... 100
Starting and ramp-down time	s	0 ... 20	0 ... 20	1 ... 360
Torque control				✓
Starting/stopping torque	%	—	—	20 ... 100
Torque limit	%	—	—	20 ... 200
Ramp time	s	—	—	1 ... 360
Integral bypass contact system		✓ ²⁾	✓	✓
Intrinsic device protection		—	✓	✓
Motor overload protection		—	✓	✓
Thermistor motor protection		—	—	✓
Adjustable current limiting		—	✓	✓
Inside-delta circuit		—	—	✓
Breakaway pulse		—	—	✓
Creep speed in both directions		—	—	✓
Pump ramp-down		—	—	✓ ⁷⁾
DC braking		—	—	✓ ^{3) 7)}
Combined braking		—	—	✓ ^{3) 7)}
Motor heating		—	—	✓ ⁴⁾
Communication		—	—	with PROFIBUS DP ⁴⁾ (option)
External display and operator module		—	—	(option ⁴⁾)
LCD Operating measured value display		—	—	✓
Error logbook		—	—	✓ ⁴⁾
Event list		—	—	✓ ⁴⁾
Slave pointer function		—	—	✓ ⁴⁾
Trace function		—	—	✓ ⁵⁾
Programmable control inputs and outputs		—	—	✓
Number of parameter sets		1 (2 with 3RW31)	1	3
Parameterization software (Softstarter ES)		—	—	✓ ⁴⁾
Power semiconductors (thyristors)		2 controlled phases	2 controlled phases	3 controlled phases
Spring-loaded terminals		✓ (only 3RW30 03)	✓	✓
Screw terminals		✓	✓	✓
UL/CSA		✓ ⁶⁾	✓	✓
CE marking		✓	✓	✓
Soft starting under heavy starting conditions		—	—	✓ ⁷⁾
Configuring support		Win-SOFTSTARTER Technical Assistance 1-800-241-4453		

- ✓ Function is available
- Function not available

1) Soft stop not available for 3RW31.
 2) Not available for 3RW30 03.
 3) Not possible in inside-delta circuit.
 4) Start of delivery 2nd quarter of 2006.

5) Trace function with Softstarter ES software.
 6) For 3RW30 03 up to 230 V.
 7) Calculate soft starter and motor with size allowance where required.

You can find further information on the Internet at:
<http://sielect.sea.siemens.com>

SIRIUS Soft Starters

For Standard Applications

SIRIUS 3RW40 soft starters

3

Overview

SIRIUS 3RW40

SIRIUS 3RW40 soft starters have all the same advantages as the 3RW30/31 soft starters including soft start and soft stop,¹⁾ and internal bypass. At the same time they come with additional functions, i.e. selectable solid-state motor overload, intrinsic device protection and adjustable current limiting, as well as a new patented two-phase control method (Polarity Balancing) that is unique in this rating range.

SIRIUS 3RW40 soft starters are part of the SIRIUS modular system. This results in advantages such as identical sizes and a uniform connection system. Thanks to their particularly compact design, SIRIUS 3RW40 soft starters are only half as big as comparable wye-delta starters. Hence they can be mounted in compact space requirements in the control cabinet. Configuring and installation are carried out quickly and easily thanks to the 3-wire connection.

SIRIUS 3RW40 for three-phase motors

Soft starters rated up to 300 Hp (at 460 V) for standard applications in three-phase power systems. Extremely small sizes, low power losses and simple commissioning are just three of the many advantages of the SIRIUS 3RW40 soft starters.



3RW40 56-6BB44



3RW40 76-6BB44

Area of application

The SIRIUS 3RW40 solid-state soft starters are suitable for soft starting and stopping of three-phase asynchronous motors.

Using the patented two-phase control, the current is kept at minimum values in all three phases throughout the entire starting time and typical direct current components are eliminated. This not only enables the two-phase starting of motors up to 300 Hp (at 460 V) but also avoids the current and torque peaks which occur i.e. with wye-delta starters or other mechanical starters.

Application areas

- Fans
- Pumps
- Building/construction machines
- Presses
- Escalators
- Transport systems
- Air conditioning systems
- Ventilators
- Assembly lines
- Compressors and coolers
- Operating mechanisms

Applicable standards

- IEC 60947-2
- UL/CSA #E143112

Ambient temperature 40 °C					Ambient temperature 50 °C					Size	Order No.	List Price \$	Approx. weight per PU
Rated operating current I_e	Rated output of three-phase induction motors for rated operating voltage U_e				Rated operating current I_e	Rated output of three-phase induction motors for rated operating voltage U_e							
A	200 V	230 V	460 V	575 V	A	200 V	230 V	460 V	575 V				
	hp	hp	hp	hp		hp	hp	hp	hp				
Inline circuit, rated operating voltage 200 ... 460 V													
134	40	50	100	–	117	30	40	75	–	S6	3RW40 55-□BB□4	2,000.00	5.700
162	50	60	125	–	145	40	50	100	–		3RW40 56-□BB□4	2,200.00	5.700
230	75	75	150	–	205	60	75	150	–	S12	3RW40 73-□BB□4	2,575.00	7.000
280	75	100	200	–	248	75	100	200	–		3RW40 74-□BB□4	2,900.00	7.000
356	100	125	250	–	315	100	125	250	–	S12	3RW40 75-□BB□4	3,200.00	7.000
432	150	150	350	–	385	125	1250	300	–		3RW40 76-□BB□4	4,100.00	7.000
Inline circuit, rated operating voltage 400 ... 600 V													
134	–	–	100	125	117	–	–	75	100	S6	3RW40 55-□BB□5	2,300.00	5.700
162	–	–	125	150	145	–	–	100	150		3RW40 56-□BB□5	2,530.00	5.700
230	–	–	150	200	205	–	–	150	200	S12	3RW40 73-□BB□5	2,970.00	7.000
280	–	–	200	250	248	–	–	200	250		3RW40 74-□BB□5	3,340.00	7.000
356	–	–	250	350	315	–	–	250	300	S12	3RW40 75-□BB□5	3,680.00	7.000
432	–	–	350	450	385	–	–	300	400		3RW40 76-□BB□5	4,720.00	7.000

Order No. extension for connection method

- with spring-loaded terminals
- with screw-type terminals

Order No. extension for the rated control supply voltage U_s ²⁾

- 115 V AC
- 230 V AC

1) Soft stop not available on 3RW31.

2) Control by way of the internal 24 V DC supply and direct control by means of PLC possible.

Selection of the soft starter depends on the motor's rated current.







2
6
3
4

The SIRIUS 3RW40 solid-state soft starters are designed for easy starting conditions. $J_{Load} < 10 \times J_{Motor}$. In the event of deviating conditions or increased duty cycle, it may be necessary to choose a larger device. Siemens recommends the use of the selection and simulation program Win-SOFTSTARTER. See technical information for information about rated currents for ambient temperatures > 40 °C.

SIRIUS Soft Starters For Standard Applications

SIRIUS 3RW40 soft starters

Accessories

For soft starters		Design	Order No.	List Price \$	Approx. weight per PU		
Type	Size	Rated control supply voltage U_c			kg		
Box terminal block for soft starters							
for round and ribbon cables							
	3RW40 5.	S6	• up to 70 mm ² • up to 120 mm ²	2/0 AWG 4/0 AWG	3RT19 55-4G 3RT19 56-4G	60.00 70.00	0.237 0.270
	3RW40 7.	S12	• up to 240 mm ²	500 MCM	3RT19 66-4G	148.00	0.676
Covers for soft starters							
Terminal cover for box terminals							
additional touch protection to be fitted at the box terminals (2 items required per device)							
	3RW40 5.	S6			3RT19 56-4EA2	25.00	0.028
	3RW40 7.	S12			3RT19 66-4EA2	35.00	0.038
Terminal cover for cable lug and busbar connection							
	3RW40 5.	S6			3RT19 56-4EA1	23.00	0.067
	3RW40 7.	S12			3RT19 66-4EA1	35.00	0.124
Sealing cover							
	3RW40 5. and 3RW40 7.	S6, S12			3RW49 00-0PB00	62.00	0.010
Modules for RESET							
Module for remote RESET, electrical							
Working range 0.85 ... 1.1 x U_c , power consumption AC 80 VA, DC 70 W, ON period 0.2 s ... 4 s, operating frequency 60/h							
	3RW40 5. and 3RW40 7.	S6, S12	• 24 V ... 30 V AC/DC • 110 V ... 127 V AC/DC • 220 V ... 250 V AC/DC		3RU19 00-2AB71 3RU19 00-2AF71 3RU19 00-2AM71	49.00 49.00 49.00	0.066 0.067 0.066
Mechanical RESET comprising							
	3RW40 5. and 3RW40 7.	S6, S12	• Overload reset adapter with pushbutton and reset extension • Reset pushbutton IP65, Ø 22 mm, 12 mm stroke • Reset extension • Complete Assembly		3RU19 00-1A 3SB30 00-0EA11 3SX13 35 3SBES-RESET	12.00 15.50 1.45 35.00	0.038 0.021 0.004
See page 4/17 of the Industrial Controls catalog for dimensional data							
Cable release with holder for RESET							
For Ø 6.5 mm holes in the control panel; max. control panel thickness 8 mm							
	3RW40 5. and 3RW40 7.	S6, S12	• Length 400 mm • Length 600 mm		3RU19 00-1B 3RU19 00-1C	55.00 60.00	0.063 0.073

Components

For soft starters		Design	Order No.	List Price \$	Approx. weight per PU	
Type	Size	Rated control supply voltage U_c			kg	
Fans						
Fans for SIRIUS 3RW40 soft starters						
maximum 1 item per 3RW40 soft starter required						
	3RW40 5.-.BB3.	S6	115 V AC	3RW49 36-8VX30	345.00	0.300
	3RW40 5.-.BB4.	S6	230 V AC	3RW49 36-8VX40	345.00	0.300
	3RW40 7.-.BB3.	S12	115 V AC	3RW49 47-8VX30	345.00	0.600
	3RW40 7.-.BB4.	S12	230 V AC	3RW49 47-8VX40	345.00	0.500

SIRIUS Soft Starters

For High Feature Applications

SIRIUS 3RW44 soft starters

3

Overview

SIRIUS 3RW44

In addition to soft starting and soft stopping, the solid-state SIRIUS 3RW44 soft starters provide numerous functions for higher-level requirements. They cover a rating range up to 950hp at 460 V in the inline circuit¹⁾.

The SIRIUS 3RW44 soft starters are characterized by a compact design for space-saving and clearly arranged control cabinet layouts. For optimized motor starting and stopping, the innovative SIRIUS 3RW44 soft starters are an attractive alternative with considerable savings potential compared to applications with a frequency converter. The new torque control and adjustable current limiting enable these high feature soft starters to be used in nearly every conceivable task. They reliably mitigate the sudden torque applications and current peaks during motor starting and stopping. This creates savings potential when calculating the size of the controlgear and when servicing the machinery installed. Be it for inline circuits or inside-delta circuits – the SIRIUS 3RW44 soft starter offers savings especially in terms of size and equipment costs.

Combinations of various starting, operating and ramp-down possibilities ensure an optimum adaptation to the application-specific requirements. Operating and commissioning can be performed by means of the user-friendly keypad and a menu-prompted, multi-line graphic display with background lighting. The optimized motor ramp-up and ramp-down can be effected by means of just a few settings with a previously selected language. Four-key operation and plain-text displays for each menu point guarantee full clarity at every moment of the parameterization and operation.

Applicable standards

- IEC 60947-4-2
- UL/CSA #E143112

¹⁾ Current range available up to 300hp at 460 V. Full range will be available in 2006.

Area of application

The SIRIUS 3RW44 solid-state soft starters are suitable for the torque-controlled soft starting and smooth ramp-down as well as braking of three-phase asynchronous motors.

Application areas, e.g.

- Pumps
- Ventilators
- Compressors
- Water transport
- Conveying systems and lifts
- Hydraulics
- Machine tools
- Mills
- Saws
- Breakers
- Mixers
- Centrifuges
- Industrial cooling and refrigerating systems

SIRIUS Soft Starters For High Feature Applications

SIRIUS 3RW44 soft starters

3

Selection and ordering data



3RW44 27-1BC44



3RW44 36-6BC44



3RW44 47-6BC44

Ambient temperature 40 °C					Ambient temperature 50 °C					Order No.	List Price \$	Approx. weight per PU kg
Rated operating current I_e A	Rated output of three-phase induction motors for rated operating voltage U_e				Rated operating current I_e A	Rated output of three-phase induction motors for rated operating voltage U_e						
	200 V hp	230 V hp	460 V hp	575 V hp		200 V hp	230 V hp	460 V hp	575 V hp			
Inline circuit, rated operating voltage 200 ... 460 V												
29	7.5	10	15	–	26	7.5	7.5	15	–	3RW44 22-□BC□4	2090.00	4.900
36	10	10	25	–	32	10	10	20	–	3RW44 23-□BC□4	2210.00	4.900
47	10	15	30	–	42	10	15	25	–	3RW44 24-□BC□4	2230.00	4.900
57	15	20	40	–	51	15	15	30	–	3RW44 25-□BC□4	2650.00	4.900
77	20	25	60	–	68	20	20	50	–	3RW44 26-□BC□4	2780.00	4.900
93	30	30	60	–	82	25	25	60	–	3RW44 27-□BC□4	3340.00	4.900

Order No. extension for connection method

- with spring-loaded terminals
- with screw-type terminals

113	30	40	75	–	100	30	30	75	–	3RW44 34-□BC□4	3940.00	7.900
134	40	50	100	–	117	30	40	75	–	3RW44 35-□BC□4	4160.00	7.900
162	50	60	125	–	145	40	50	100	–	3RW44 36-□BC□4	5400.00	7.900
203	60	75	150	–	180	50	60	125	–	3RW44 43-□BC□4	5870.00	10.300
250	75	100	200	–	215	60	75	150	–	3RW44 44-□BC□4	6190.00	10.300
313	100	125	250	–	280	75	100	200	–	3RW44 45-□BC□4	6710.00	10.300
356	100	125	250	–	315	100	125	250	–	3RW44 46-□BC□4	7460.00	10.300
432	150	150	350	–	385	125	150	300	–	3RW44 47-□BC□4	8300.00	10.300

Order No. extension for connection method

- with spring-loaded terminals
- with screw-type terminals

29	–	–	15	25	26	–	–	15	20	3RW44 22-□BC□5	2410.00	4.900
36	–	–	25	30	32	–	–	20	25	3RW44 23-□BC□5	2550.00	4.900
47	–	–	30	40	42	–	–	25	30	3RW44 24-□BC□5	2570.00	4.900
57	–	–	40	50	51	–	–	30	40	3RW44 25-□BC□5	3050.00	4.900
77	–	–	60	75	68	–	–	50	50	3RW44 26-□BC□5	3200.00	4.900
93	–	–	60	75	82	–	–	60	75	3RW44 27-□BC□5	3850.00	4.900

Order No. extension for connection method

- with spring-loaded terminals
- with screw-type terminals

113	–	–	75	100	100	–	–	75	75	3RW44 34-□BC□5	4540.00	7.900
134	–	–	100	125	117	–	–	75	100	3RW44 35-□BC□5	4790.00	7.900
162	–	–	125	150	145	–	–	100	125	3RW44 36-□BC□5	6210.00	7.900
203	–	–	150	200	180	–	–	125	150	3RW44 43-□BC□5	6760.00	10.300
250	–	–	200	250	215	–	–	150	200	3RW44 44-□BC□5	7120.00	10.300
313	–	–	250	300	280	–	–	200	250	3RW44 45-□BC□5	7720.00	10.300
356	–	–	250	350	315	–	–	250	300	3RW44 46-□BC□5	8580.00	10.300
432	–	–	350	450	385	–	–	300	400	3RW44 47-□BC□5	9550.00	10.300

Order No. extension for connection method

- with spring-loaded terminals
- with screw-type terminals

Order No. extension for the rated control supply voltage U_s ¹⁾

- 115 V AC
- 230 V AC

1) Control by way of the internal 24 V DC supply and direct control by means of PLC possible.

Soft starter selection depends on the motor's rated current.

The 3RW44 solid-state soft starters are designed for normal starting (class 10). (Inertia load of the overall operating mechanism $J_{Load} < 10 \times J_{Motor}$; starting current 350 % $\times I_e$ for 20 s or similar load.) For any other conditions of use, the devices should be selected using the selection and simulation program Win-SOFTSTARTER. See technical specifications for information about rated currents for ambient temperatures > 40 °C and operating frequency.

SIRIUS Soft Starters For High Feature Applications

SIRIUS 3RW44 soft starters

3



3RW44 36-6BC44



3RW44 47-6BC44

Ambient temperature 50 °C					Order No.	List Price \$	Approx. weight per PU kg
Rated operating current I_e	Rated output of three-phase induction motors for rated operating voltage U_e						
	200 V	230 V	460 V	575 V			
A	hp	hp	hp	hp			
Inside-delta circuit, rated operating voltage 200 ... 460 V							
45	10	15	–	–	3RW44 22-□BC□4	2090.00	4.900
55	15	20	–	–	3RW44 23-□BC□4	2210.00	4.900
73	20	25	–	–	3RW44 24-□BC□4	2230.00	4.900
88	25	30	–	–	3RW44 25-□BC□4	2650.00	4.900
118	30	40	–	–	3RW44 26-□BC□4	2780.00	4.900
142	40	50	–	–	3RW44 27-□BC□4	3340.00	4.900
Order No. extension for connection method							
<ul style="list-style-type: none"> with spring-loaded terminals with screw-type terminals 					3 1		
173	50	60	–	–	3RW44 34-□BC□4	3940.00	7.900
203	60	75	–	–	3RW44 35-□BC□4	4160.00	7.900
251	75	100	–	–	3RW44 36-□BC□4	5400.00	7.900
312	100	125	–	–	3RW44 43-□BC□4	5870.00	10.300
372	125	150	–	–	3RW44 44-□BC□4	6190.00	10.300
485	150	200	–	–	3RW44 45-□BC□4	6710.00	10.300
546	150	200	–	–	3RW44 46-□BC□4	7460.00	10.300
667	200	250	–	–	3RW44 47-□BC□4	8300.00	10.300
Order No. extension for connection method							
<ul style="list-style-type: none"> with spring-loaded terminals with screw-type terminals 					2 6		
Inside-delta circuit, rated operating voltage 400 ... 600 V							
45	–	–	30	40	3RW44 22-□BC□5	2410.00	4.900
55	–	–	40	50	3RW44 23-□BC□5	2550.00	4.900
73	–	–	50	60	3RW44 24-□BC□5	2570.00	4.900
88	–	–	60	75	3RW44 25-□BC□5	3050.00	4.900
118	–	–	75	100	3RW44 26-□BC□5	3200.00	4.900
142	–	–	100	125	3RW44 27-□BC□5	3850.00	4.900
Order No. extension for connection method							
<ul style="list-style-type: none"> with spring-loaded terminals with screw-type terminals 					3 1		
173	–	–	125	150	3RW44 34-□BC□5	4540.00	7.900
203	–	–	150	200	3RW44 35-□BC□5	4790.00	7.900
251	–	–	200	250	3RW44 36-□BC□5	6210.00	7.900
312	–	–	250	300	3RW44 43-□BC□5	6760.00	10.300
372	–	–	300	350	3RW44 44-□BC□5	7120.00	10.300
485	–	–	400	500	3RW44 45-□BC□5	7720.00	10.300
546	–	–	450	600	3RW44 46-□BC□5	8580.00	10.300
667	–	–	600	750	3RW44 47-□BC□5	9550.00	10.300
Order No. extension for connection method							
<ul style="list-style-type: none"> with spring-loaded terminals with screw-type terminals 					2 6		
Order No. extension for the rated control supply voltage U_s¹⁾							
<ul style="list-style-type: none"> 115 V AC 230 V AC 					3 4		

1) Control by way of the internal 24 V DC supply and direct control by means of PLC possible.



Soft starter selection depends on the motor's rated current.

The 3RW44 solid-state soft starters are designed for normal starting (class 10). (Inertia load of the overall operating mechanism $J_{Load} < 10 \times J_{Motor}$; starting current $350 \% \times I_e$ for 20 s or similar load.) For any other conditions of use, the devices should be selected using the selection and simulation program Win-SOFTSTARTER. See technical specifications for information about rated currents for ambient temperatures $> 40 \text{ °C}$ and operating frequency.

SIRIUS Soft Starters For High Feature Applications

SIRIUS 3RW44 soft starters

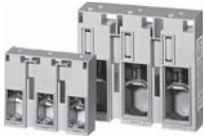
Accessories

For soft starters	Design	Order No.	List Price \$	Approx. weight per PU	
Type				kg	
Box terminal block for soft starters					
Box terminal block					
	3RW44 2.	included in delivery			
	3RW44 3.	<ul style="list-style-type: none"> up to 70 mm² 2/0 AWG up to 120 mm² 4/0 AWG 	3RT19 55-4G 3RT19 56-4G	 60.00 70.00	 0.237 0.270
	3RW44 3.	<ul style="list-style-type: none"> up to 240 mm² 500 MCM 	3RT19 66-4G	148.00	0.676
Covers for soft starters					
Terminal cover for box terminals					
	additional touch protection to be fitted at the box terminals (2 items required per device)				
	3RW44 2. and 3RW44 3.		3RT19 56-4EA2	25.00	0.028
	3RW44 4.		3RT19 66-4EA2	35.00	0.038
Terminal cover for cable lug and busbar connection					
	3RW44 2. and 3RW44 3.		3RT19 56-4EA1	23.00	0.067
	3RW44 4.		3RT19 66-4EA1	35.00	0.124

Components

For soft starters	Design	Order No.	List Price \$	Approx. weight per PU	
Type				kg	
Fans					
	3RW44 2. and 3RW44 3.	115 V AC	3RW49 36-8VX30	345.00	0.300
		230 V AC	3RW49 36-8VX40	345.00	0.300
	3RW44 4.	115 V AC	3RW49 47-8VX30	345.00	0.500
		230 V AC	3RW49 47-8VX40	345.00	0.500

SIRIUS Soft Starters

For Standard Applications

SIRIUS 3RW40 soft starters

3

Function

SIRIUS 3RW40 soft starters have all the same advantages as the 3RW30/31 soft starters. At the same time they come with additional functions and a two-phase control method (Polarity Balancing) that is unique in the rating range up to 300Hp at 460V. Starting voltage, starting and ramp-down time of the voltage ramp and current limit are all easy to set using stepless rotary potentiometers, the same as on the SIRIUS 3RW30/31. The rated motor current, the setting of the tripping time and the resetting of the motor overload function are controlled like the SIRIUS overload relays by means of potentiometers and pushbuttons.

SIRIUS 3RW40 features the new, patented control method called Polarity Balancing for avoiding direct current components in two-phase controlled soft starters. On two-phase controlled soft starters the current resulting from superimposition of the two controlled phases flows in the uncontrolled phase. This results for physical reasons in an asymmetric distribution of the three phase currents during the starting operation of the motor. In most applications it is non-critical. Controlling the power semi-conductors in the two controlled phases results not only in this asymmetry, however, but also in the previously mentioned direct current components which can cause severe noise generation on the motor at starting voltages of less than 50 %. Polarity Balancing reliably eliminates these direct current components during the starting phase. It creates a motor ramp-up that is uniform in speed, torque and current rise. As the result, the acoustic quality of the starting operation nearly attains the quality of a three-phase controlled starting operation. This is made possible by the on-going dynamic balancing of current half-waves of different polarity during the motor ramp-up.

The SIRIUS 3RW40 is equipped with optimum functionality. An integral bypass contact system reduces the power loss of the soft starter during operation. This reliably prevents heating of the controlgear environment. Using a 4-step rotary potentiometer it is possible to set different overload tripping times. Thanks to the integral motor overload protection according to IEC 60947-4-2, there is no need of an additional overload relay. This saves space in the control cabinet and wiring work in the feeder. Internal intrinsic device protection prevents the thermal overloading of the thyristors and the power section defects this can cause.

As an option the thyristors can also be protected by SITOR semiconductor fuses from short-circuiting. And even inrush current peaks are reliably avoided thanks to adjustable current limiting. Three LEDs are used to indicate the operating status as well as possible errors, such as non-permissible tripping time (CLASS setting), mains or phase failure, missing load, thermal overloading or device faults.

We supply a comprehensive range of accessories for our soft starters. Examples include box terminal blocks, accessories for mechanical reset and a module for remote reset, a sealing cover or easy-to-fit terminal covers for optimum shock-hazard protection.

Highlights

- Soft starting with voltage ramp; the starting voltage adjustment range U_s is 40 to 100 % and the ramp time t_R can be set from 0 to 20 s.
- Smooth ramp-down with voltage ramp; the running down time can be set between 0 and 20 s. The switch-off voltage U_{off} is then dependent on the selected starting voltage U_s .
- Solid-state motor overload and intrinsic device protection
- Adjustable current limiting
- Integrated bypass contact system to minimize dissipated power
- Setting with three potentiometers
- Simple mounting and commissioning
- Mains voltages 50/60 Hz, 200 to 600 V
- Two control voltage versions 115 V AC and 230 V AC. Control by way of the internal 24 V DC supply and direct control by means of PLC are possible.
- Wide temperature range from -25 to +60 °C
- Built-in auxiliary contacts ensure user-friendly control and possible further processing within the system (for status graphs see page 3/17)

Technical specifications

Type	3RW40 5.		3RW40 7.	
Control electronics				
Rated values	Terminal A1/A2	V AC	115 -15/+10	230
Rated control supply voltage		%		
• Tolerance				
Rated control supply current STANDBY		mA	15	
Rated control supply current ON ¹⁾		mA	440	200
Rated frequency		Hz	50/60	
• Tolerance		%	±10	
Control inputs				
IN			ON/OFF	
Rated operating current		mA	approx. 10 according to DIN 19240	
Rated operating voltage		V DC	24 from internal supply dc+ or external DC supply (to DIN 19240) through terminals and IN	
Relay outputs				
Output 1	ON/RUN mode ²⁾	13/14	Operating indication	
Output 2	BYPASSED	23/24	Bypass indication	
Output 3	OVERLOAD/ FAILURE	95/96/97	Overload/error indication	
Rated operating current		A	3 AC-15/AC-14 at 230 V	
Rated operating voltage			1 DC-13 at 24 V, B300/R300	
Protection against overvoltages			Protection by means of Varistor through contact	
Short-circuit protection			4 A operational class gL/gG; 6 A quick (fuse is not included in scope of supply)	

1) Values for the coil power consumption at +10 % U_n , 50 Hz.

2) Factory presetting: ON mode.

SIRIUS Soft Starters For Standard Applications

SIRIUS 3RW40 soft starters

3

Type	3RW40 ..				
Control electronics					
Operating indications	LED	DEVICE	STATE/BYPASSED	FAILURE	OVERLOAD
Off		green	off	off	off
Start		green	green flashing	off	off
Bypass		green	green	off	off
Ramp-down		green	green flashing	off	off
Alarm indications					
I_e /class setting not permissible		off	off	off	red flashing
Start inhibited/thyristors too hot		yellow flashing	off	off	off
Fault indications					
$U < 0.75 \times U_s$ or $U > 1.15 \times U_s$		off	off	red	off
Non-permissible I_e /class setting for edge 0 → 1		green	off	red	red flashing
Motor protection shut-down		green	off	off	red
Thermal overloading of the thyristors		yellow	off	red	off
Missing load		green	off	red	off
Device error		red	off	red	off
Protective functions					
Motor protection functions					
Trips in the event of		thermal overloading of the motor			
Trip class to IEC 60947-4-1	Class	10/15/20			
Phase loss sensitivity	%	> 40			
Overload warning		no			
Reset option after tripping		Manual/automatic (MAN/AUTO)			
Recovery time	min	5			
Device protection function					
Trips in the event of		thermal overloading of the thyristors			
Reset option after tripping		Manual/automatic (MAN/AUTO)			
Recovery time	s	30			

Type	3RW40 ..	
Control times and parameters		
Control times		
Closing delay (with connected control voltage)	ms	< 50
Closing delay (automatic/mains contactor mode)	ms	< 300
Recovery time (closing command in active ramp-down)	ms	100
Mains failure bridging time		
Control supply voltage	ms	50
Mains failure response time		
Load current circuit	ms	500
Restart lockout after protection trip		
Motor protection trip	min	5
Device protection trip	s	30
Starting parameters		
Starting time	s	0 ... 20
Starting voltage	%	40 ... 100
Starting current limit	%	1.3 ... $5 \times I_e$
Ramp-down parameters		
Ramp-down time	s	0 ... 20
Reset mode parameters (for motor/device protection shut-down)		
Manual reset	LED AUTO	off
Automatic reset	LED AUTO	yellow
Start-up detection		yes

SIRIUS Soft Starters For Standard Applications

SIRIUS 3RW40 soft starters

3

Type	3RW40 ...-BB4.	3RW40 ...-BB5.
Power electronics		
Rated operating voltage for inline circuit	V AC 200 ... 460	400 ... 600
Tolerance	% -15/+10	-15/+10
Rated frequency	Hz 50/60	
Tolerance	% ±10	
Continuous operation at 40 °C (% of I_e)	% 115	
Minimum load (% of I_e)	% 20	
Maximum conductor length between soft starter and motor	m 200	
Permissible installation height	m 2000 (derating from 1000); higher on request ⁵⁾	
Permissible mounting position		
Permissible ambient temperature		
Operation	°C -25 ... +60; (derating from +40)	
Storage	°C -40 ... +80	
Degree of protection	IP00	

Type	3RW40 55	3RW40 56	3RW40 73	3RW40 74	3RW40 75	3RW40 76
Power electronics						
Load rating with rated operating current I_e	Acc. to IEC and UL/CSA for individ. mounting at 40/50/60 °C, AC-53a A					
	134/117/100	162/145/125	230/205/180	280/248/215	356/315/280	432/385/335
Smallest adjustable rated motor current I_M for the motor overload protection	A 59	87	80	130	131	207
Power loss	At continuous rated operating current (40 °C) approx.					
For current limiting at 350% I_M (40 °C)	W 60	75	75	90	125	165
	W 1043	1355	2448	3257	3277	3600
Permissible rated motor current and starts per hour						
• For normal starting (Class 10)						
- Rated motor current $I_M^{(1)}$, starting time 10 s	A 134	162	230	280	356	432
- Starts per hour ²⁾	1/h 20	8	20	14	16	17
- Rated motor current $I_M^{*(1)3)}$, starting time 20 s	A 134	162	230	280	356	432
- Starts per hour ²⁾	1/h 7	1.4	9	3	5	5
• For heavy starting (Class 15)						
- Rated motor current $I_M^{(1)}$, starting time 15 s	A 134	152	230	250	341	402
- Starts per hour ²⁾	1/h 11	8	13	12	11	12
- Rated motor current $I_M^{*(1)3)}$, starting time 30 s	A 134	152	230	250	341	402
- Starts per hour ²⁾	1/h 1.2	1.7	5	2	1.5	2
• For heavy starting (Class 20)						
- Rated motor current $I_M^{(1)}$, starting time 20 s	A 124	142	230	230	311	372
- Starts per hour ²⁾	1/h 12	9	9	9	10	10
- Rated motor current $I_M^{*(1)3)}$, starting time 40 s	A 124	142	230	230	311	372
- Starts per hour ⁴⁾	1/h 3	3	1	1	0.1	1

- 1) Current limit on soft starter set to 350 % I_M .
- 2) For intermittent duty S4 with ON period = 70 %, T_{ij} = 40 °C, individual mounting vertical. The quoted operating frequencies do not apply for automatic mode.
- 3) Maximum adjustable rated motor current I_M , dependent on CLASS setting.
- 4) For intermittent duty S4 with ON period = 30 %, T_{ij} = 40 °C, individual mounting vertical. The quoted operating frequencies do not apply for automatic mode.
- 5) Derating chart

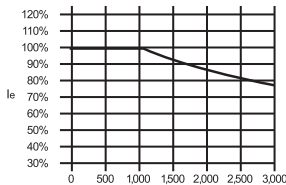







Altitude

The maximum permissible altitude is 3,000m above sea level.
Fig.: Rated operating current I_e above 1,000m above sea level.

SIRIUS Soft Starters For Standard Applications

SIRIUS 3RW40 soft starters

3

Soft starter	Type	3RW40 5.	3RW40 7.
Conductor cross-sections			
Screw terminals with box terminal front clamping point connected	Main conductor: <ul style="list-style-type: none"> finely stranded with end sleeve finely stranded without end sleeve stranded ribbon cable conductors (number x width x thickness) AWG conductor, solid or stranded 	3RT19 55-4G (55 kW) mm ² 16 ... 70 mm ² 16 ... 70 mm ² 16 ... 70 mm min. 3 x 9 x 0.8, max. 6 x 15.5 x 0.8 AWG 6 ... 2/0	3RT19 66-4G mm ² 70 ... 240 mm ² 70 ... 240 mm ² 95 ... 300 mm min. 6 x 9 x 0.8 max. 20 x 24 x 0.5 3/0 ... 600 kcmil
			
rear clamping point connected	<ul style="list-style-type: none"> finely stranded with end sleeve finely stranded without end sleeve stranded ribbon cable conductors (number x width x thickness) AWG conductor, solid or stranded 	mm ² 16 ... 70 mm ² 16 ... 70 mm ² 16 ... 70 mm min. 3 x 9 x 0.8, max. 6 x 15.5 x 0.8 AWG 6 ... 2/0	mm ² 120 ... 185 mm ² 120 ... 185 mm ² 120 ... 240 mm min. 6 x 9 x 0.8 max. 20 x 24 x 0.5 250 ... 500 kcmil
			
both clamping points connected	<ul style="list-style-type: none"> finely stranded with end sleeve finely stranded without end sleeve stranded ribbon cable conductors (number x width x thickness) AWG conductor, solid or stranded terminal screws - pickup torque 	mm ² max. 1 x 50, 1 x 70 mm ² max. 1 x 50, 1 x 70 mm ² max. 2 x 70 mm max. 2 x (6 x 15.5 x 0.8) AWG max. 2 x 1/0 M10 (hexagon socket, A/F4) 10 ... 12 90 ... 110	min. 2 x 50; max. 2 x 185 min. 2 x 50; max. 2 x 185 max. 2 x 70; max. 2 x 240 max. 2 x (20 x 24 x 0.5) min. 2 x 2/0; max. 2 x 500 kcmil M12 (hexagon socket, A/F5) 20 ... 22 180 ... 195
			
Screw terminals with box terminal front or rear clamping point connected	Main conductor: <ul style="list-style-type: none"> finely stranded with end sleeve finely stranded without end sleeve stranded ribbon cable conductors (number x width x thickness) AWG conductor, solid or stranded 	3RT19 56-4G mm ² 16 ... 120 mm ² 16 ... 120 mm ² 16 ... 120 mm min. 3 x 9 x 0.8 max. 6 x 15.5 x 0.8 AWG 6 ... 250 kcmil	
 			
both clamping points connected	<ul style="list-style-type: none"> finely stranded with end sleeve finely stranded without end sleeve stranded ribbon cable conductors (number x width x thickness) AWG conductor, solid or stranded 	mm ² max. 1 x 95, 1 x 120 mm ² max. 1 x 95, 1 x 120 mm ² max. 2 x 120 mm max. 2 x (10 x 15.5 x 0.8) AWG max. 2 x 3/0	
			
Screw terminals	Main conductor: <u>Without box terminal/rail connection</u> <ul style="list-style-type: none"> finely stranded with cable lug stranded with cable lug AWG conductor, solid or stranded connecting bar (max. width) terminal screws - Pickup torque 	mm ² 16 ... 95 ¹⁾ mm ² 25 ... 120 ¹⁾ AWG 4 ... 250 kcmil mm 17 Nm M8 x 25 (A/F13) lb.in 10 ... 14 89 ... 124	mm ² 50 ... 240 ²⁾ mm ² 70 ... 240 ²⁾ 2/0 ... 500 kcmil 25 M10 x 30 (A/F17) 14 ... 24 124 ... 210

1) When connecting cable lugs to DIN 46235 use 3RT19 56-4EA1 terminal cover for conductor cross-sections from 95 mm² to ensure phase spacing.

2) When connecting cable lugs to DIN 46234, the 3RT19 66-4EA1 terminal cover must be used for conductor cross-sections of 240 mm² and more as well as DIN 46235 for conductor cross-sections of 185 mm² and more to keep the phase clearance.

Soft starter	Type	3RW40 ..
Conductor cross-sections		
Auxiliary conductors (1 or 2 conductors can be connected):		
	Screw terminals <ul style="list-style-type: none"> solid finely stranded with end sleeve AWG cables <ul style="list-style-type: none"> solid or stranded finely stranded with end sleeve terminal screws - pickup torque 	mm ² 2 x 0.5 ... 2.5 mm ² 2 x 0.5 ... 1.5 AWG 2 x 20 ... 14 AWG 2 x 20 ... 16 Nm 0.7 ... 0.9 lb.in 7 ... 8
	Spring-loaded terminals <ul style="list-style-type: none"> solid finely stranded with end sleeve AWG conductor, solid or stranded 	mm ² 2 x 0.25 ... 2.5 mm ² 2 x 0.25 ... 1.5 AWG 2 x 24 ... 14

SIRIUS Soft Starters For Standard Applications

SIRIUS 3RW40 soft starters

3

	Standard	Parameters
Electromagnetic compatibility acc. to EN 60947-4-2		
<i>EMC interference immunity</i>		
Electrostatic discharge (ESD)	EN 61000-4-2	±4 kV contact discharge, ±8 kV air discharge
Electromagnetic RF fields	EN 61000-4-3	Frequency range: 80 ... 1000 MHz with 80 % at 1 kHz Degree of severity 3: 10 V/m
Conducted RF interference	EN 61000-4-6	Frequency range: 150 kHz ... 80 MHz with 80 % at 1 kHz Interference 10 V
RF voltages and RF currents on conductors		
Burst	EN 61000-4-4	±2 kV/5 kHz
Surge	EN 61000-4-5	±1 kV line to line
<i>EMC interference emission</i>		
EMC interference field strength	EN 55011	Limit value of Class A at 30 ... 1000 MHz
Radio interference voltage	EN 55011	Limit value of Class A at 0.15 ... 30 MHz
<i>Is an RI suppression filter necessary?</i>		
Degree of noise suppression A (industrial applications)	no	
Shock	IEC 68-2-27	Half sine 15g/11ms
Vibration	IEC 68-2-6	10 ... 57Hz (constant amplitude 0.15mm) 58 ... 150Hz (constant acceleration 2g)
Short Circuit	3RW405 3RW407	10 kA, 600 V AC, max. Fuse 450 A 30 kA, 600 V AC, max. Fuse 1200 A

Characteristic curves

Motor protection tripping characteristic curves for 3RW40 (with symmetry)

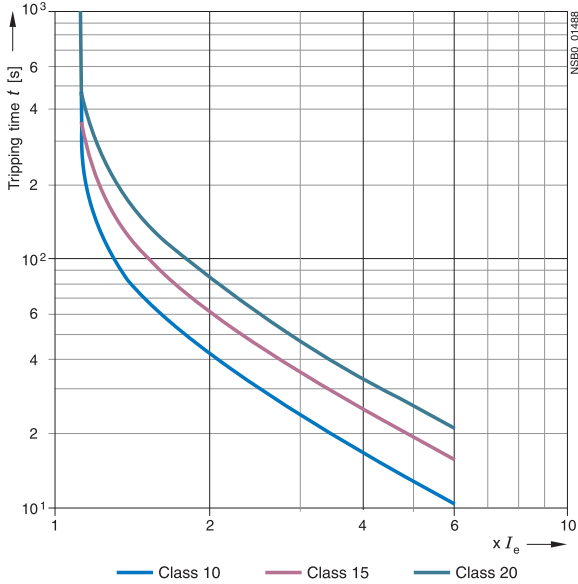

Dimensional drawings

3RW40

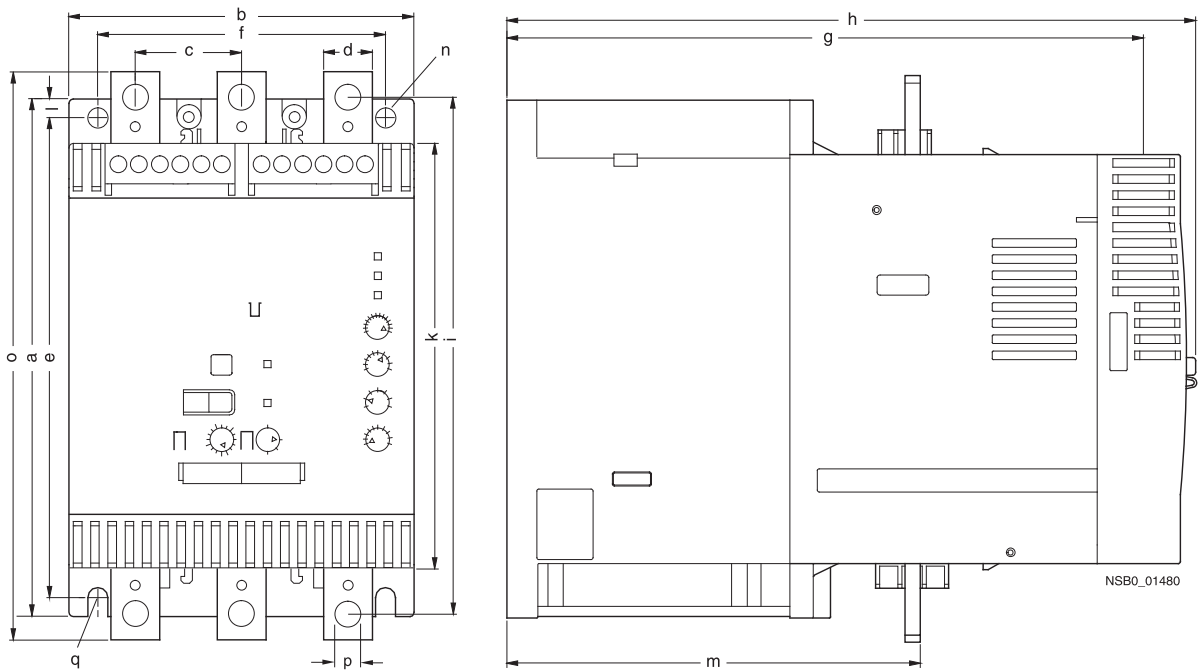

Type/Dimension (mm)	a	b	c	d	e	f	g	h	i	k	l	m	n	o	p	q
3RW40 5.	180	120	37	17	167	100	223	250	180	148	6.5	153	7	198	9	M6, 10 Nm
3RW40 7.	210	160	48	25	190	140	240	278	205	166	10	166	9	230	11	M8, 15 Nm

SIRIUS Soft Starters For Standard Applications

SIRIUS 3RW40 soft starters

3

Schematics

Connection examples for control

Control by means of switch through internal 24 V DC supply

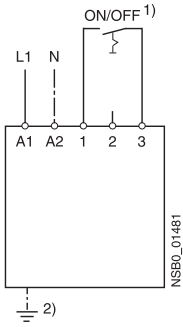

external voltage supply

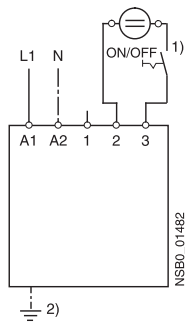

Control with button

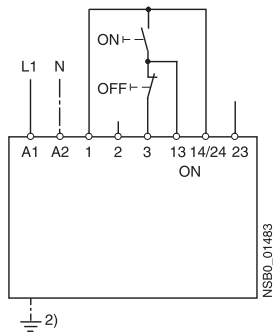

of a main contactor

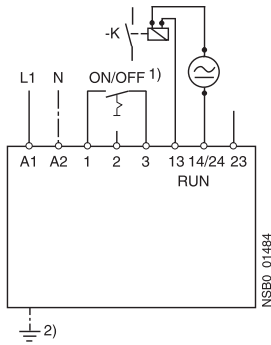

Connection examples for main circuit³⁾

3RW40 – 3-phase motor with 3NA/3NE fuse

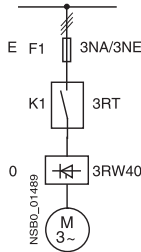

3VL circuit-breaker

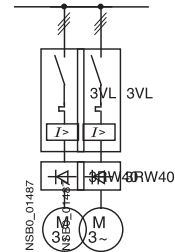

1) Caution: Risk of restarting!

When operating with a switch (ON/OFF) a new, automatic restart will take place automatically if the start command is still active at terminal 3.

2) Grounding necessary for fan connection to 3RW40 5....

3) As an alternative, the motor feeder can also be installed as a fuseless or as a fused version. The wiring diagrams are provided only as examples.

Further information

Configuring

The 3RW solid-state soft starters are designed for easy starting conditions. In the event of deviating conditions or increased switching frequency, it may be necessary to choose a larger device. For accurate dimensioning, use the selection and simulation program Win-SOFTSTARTER (Version 2.0 or higher) can be used.

If necessary, an overload relay for heavy-starting must be selected where long starting times are involved. PTC thermistor detectors are recommended. This also applies for the soft ramp-down because during the ramp-down time an additional current loading applies in contrast to free ramp-down.

In the motor feeder between the SIRIUS 3RW soft starter and the motor, no capacitive elements are permitted (e.g. no compensation equipment). In addition, active filters (e.g. for reactive-power compensation) must not be operated in parallel during use of the soft starter.

All elements of the main circuit (such as fuses, switching devices and overload relays) should be dimensioned for direct starting, following the local short-circuit conditions. Fuses, switching devices and overload relays must be ordered separately. Please observe the maximum switching frequencies specified in the technical specifications.

Power electronics circuit diagram

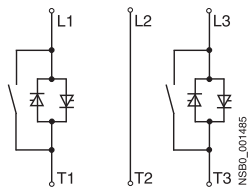

Status graphs

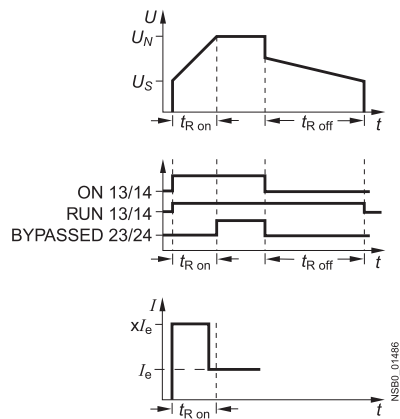

Win-SOFTSTARTER selection and simulation program

With this software, you can simulate and select all Siemens soft starters, taking into account various parameters such as mains properties, motor and load data, and special application requirements.

The software is a valuable tool, which makes complicated, lengthy manual calculations for determining the required soft starters superfluous.

You can find further information on the Internet at: <http://sielect.sea.siemens.com>

SIRIUS Soft Starters

For High Feature Applications

SIRIUS 3RW44 soft starters

3

Function

Equipped with a modern, ergonomic user keypad the SIRIUS 3RW44 soft starters can be commissioned quickly and easily using a keypad and a menu-prompted, multi-line display with background lighting. The optimized motor ramp-up and ramp-down can be configured quickly, easily and reliably by means of just a few settings with a selectable language. Four-key operation and plain-text displays for each menu point ensure full clarity at every moment of the parameterization and operation. During operation and when control voltage is applied, the front panel continuously presents measured values and operating values as well as warnings and alarm indications. An external display and operator module can be connected by means of a connecting cable to the soft starter, thus enabling full control and monitoring functions to be read directly from the control cabinet door.

The SIRIUS 3RW44 soft starters are equipped with optimum functionality. An integral bypass contact system reduces the power loss of the soft starter during operation.

This reliably prevents heating of the controlgear environment. The SIRIUS 3RW44 soft starters have internal intrinsic device protection. This prevents thermal overloading of the power section's thyristors, i.e. due to unacceptably high closing operations.

Wiring work for installing an additional motor overload relay is no longer needed as the SIRIUS 3RW44 soft starters perform this function, too. In addition they offer adjustable trip classes and a thermistor motor protection function. And even inrush current peaks are reliably avoided thanks to adjustable current limiting.

As a further option the SIRIUS 3RW44 soft starters can be upgraded with a PROFIBUS DP module. Thanks to their communication capability and their programmable control inputs and relay outputs the SIRIUS 3RW44 soft starters can be very easily and quickly integrated in higher-level systems.

In addition a creep speed function is available for positioning and setting jobs. With this function the motor can be controlled in both directions of rotation with reduced torque and an adjustable, low speed.

On the other hand the SIRIUS 3RW44 soft starters offer a new, combined DC injection braking function for the fast stopping of driving loads.

Highlights

- Soft starting with breakaway pulse, torque control or voltage ramp, adjustable torque or current limiting as well as any combination of these, depending on load type
- Integrated bypass contact system to minimize dissipated power
- Various setting options for the starting parameters such as starting torque, starting voltage, ramp-up and ramp-down time, and much more in three separate parameter sets
- Start-up detection
- Inside-delta circuit for savings in terms of size and equipment costs
- Various ramp-down modes selectable: free ramp-down, torque-controlled pump stopping, combined DC injection braking
- Solid-state motor overload and intrinsic device protection
- Thermistor motor protection
- Keypad with a menu-controlled, multi-line, graphic display with background lighting
- Interface for communication with the PC for more accurate setting of the parameters as well as for control and monitoring (start of delivery of the software: 3rd quarter 2005)
- Simple adaptation to the motor feeder
- Simple mounting and commissioning
- Display of operating states and fault signals
- Connection to PROFIBUS with optional PROFIBUS DP module (start of delivery: 2nd quarter 2006).
- External display and operator module (start of delivery: 2nd quarter 2006).
- System voltages from 200 to 1000 V, 50 to 60 Hz
- Applicable up to 60 °C (derating from 40 °C)

SIRIUS Soft Starters For High Feature Applications

SIRIUS 3RW44 soft starters

3

Technical specifications

Type	Terminal		3RW44 ...-BC3.	3RW44 ...-BC4.
Control electronics				
Rated values				
Rated control supply voltage	A1/A2/PE	V	AC 115	AC 230
• Tolerance		%	-15/+10	-15/+10
Auxiliary contacts B300/R300				
Rated control supply current STANDBY		mA	30	20
Rated control supply current ON				
• 3RW442.		mA	300	170
• 3RW443.		mA	500	250
• 3RW444.		mA	750	400
Maximum current (bypass pickup)				
• 3RW442.		mA	1000	500
• 3RW443.		mA	2500	1250
• 3RW444.		mA	6000	3000
Rated frequency		Hz	50 ... 60	50 ... 60
• Tolerance		%	±10	±10

Type	Terminal		3RW44 ..	Factory presetting
Control electronics				
Control inputs				
Input 1	IN1			Start motor right (parameter set 1) no action no action Trip reset
Input 2	IN2			
Input 3	IN3			
Input 4	IN4			
Supply	L+/L-			
• Rated operational current		mA	approx. 10 per input to DIN 19240	
• Rated operating voltage	L+		Internal voltage: 24 V DC from internal supply through terminal L+ to IN1 ... IN4. Maximum load at L+ approx. 55 mA	
	L-		External voltage: DC external voltage (to DIN 19240) through terminals L- and IN1 ... IN4 (min. 12 V DC, max. 30 V DC)	
Thermistor motor protection input				
Input	T1/T2		PTC type A or Thermoclick	deactivated
Relay outputs (floating auxiliary contacts)				
Output 1	13/14			ON period no action no action Group fault
Output 2	23/24			
Output 3	33/34			
Output 4	95/96/98			
Switching capacity of the relay outputs				
230 V/AC-15		A	3 at 240 V	
24 V/DC-13		A	1 at 24 V, B300/R300	
Protection against overvoltages			Protection by means of Varistor through relay contact	
Short-circuit protection			4 A operational class gL/gG; 6 A quick (fuse is not included in scope of supply)	
Protective functions				
Motor protection functions				
Trips in the event of			thermal overloading of the motor	10
Trip class to IEC 60947-4-1		Class %	5/10/15/20/30 > 40	
Phase loss sensitivity			yes	Manual Manual 2
Overload warning			Manual/Automatic	
Reset and recovery			Manual/Automatic	
Reset option after tripping		min.	2 ... 30	
Recovery time				
Device protection functions				
Trips in the event of			thermal overloading of the thyristors	Manual
Reset option after tripping			Manual/Automatic	
Recovery time		min.	0.5	

SIRIUS Soft Starters

For High Feature Applications

SIRIUS 3RW44 soft starters

3

Type	3RW44 ..		Factory presetting
Control times and parameters			
Control times			
Closing delay (with connected control voltage)	ms	< 50	
Closing delay (automatic mode)	ms	< 4000	
Recovery time (closing command in active ramp-down)	ms	< 100	
Mains failure bridging time			
Control supply voltage	ms	100	
Mains failure response time			
Load current circuit	ms	100	
Restart lockout after overload trip			
Motor protection trip	min.	1 ... 30	1
Device protection trip	min.	0.5	
Setting options for starting			
Voltage ramp for starting voltage	%	20 ... 100	40
Torque control for starting torque	%	10 ... 100	50
Torque control for limit torque	%	20 ... 200	150
Starting time	s	0 ... 360	20
Maximum starting time	s	1 ... 1000	deactivated
Current limit value	%	125 ... 550	450
Breakaway voltage	%	40 ... 100	80
Breakaway time	s	0 ... 2	deactivated
Motor heat output	%	0 ... 100	0
Creep mode Left/Right running			
Speed factor as function of rated speed ($n = n_{rated}/factor$)		3 ... 21	7
Creep torque (reference variable depends on the motor used but is always smaller than the rated torque of the motor)	%	20 ... 100	50
Setting options for ramp-down			
Torque control for stopping torque	%	10 ... 100	40
Ramp-down time	s	0 ... 360	10
Combined braking	%	20 ... 100	50
DC braking	%	20 ... 100	50
Operating indications			
		Test voltage	
		Test mains phases	
		Ready to start	
		Start active	
		Motor running	
		Ramp-down active	
Warnings/error signals			
		Mains voltage missing	
		Wrong direction of phase rotation	
		Wrong start condition	
		Phase failure	
		• L1	
		• L2	
		• L3	
		Missing load phase	
		• L1	
		• L2	
		• L3	
		Failure	
		• Contact element 1 (thyristor)	
		• Contact element 2 (thyristor)	
		• Contact element 3 (thyristor)	
		Flash memory faulty	
		Power supply	
		• below 75 %	
		• below 85 %	
		• over 110 %	
		Current unbalance exceeded	
		Thermal motor model overload	
		Prewarning limit exceeded	
		• Motor heating	
		• Time-related trip reserve	
		Bypass elements defective	
		Mains overvoltage	
		Current range exceeded	
		Motor blocking - shutdown	
		Current limit exceeded	
		Power section overheated	
		Power section overtemperature	
		Temperature sensor	
		- Overload	
		- Wire break	
		- Short-circuit	
		Ground fault detected	
		Ground fault shutdown	
		Connection abort in manual mode	

SIRIUS Soft Starters For High Feature Applications

SIRIUS 3RW44 soft starters

Type	3RW44 ..	Factory presetting
Control times and parameters		
Control inputs Input 1 Input 2 Input 3 Input 4 Parameterizing options for control inputs 1 ... 4	no action Local manual mode Creep speed Trip reset Motor right parameter set 1 Motor left parameter set 1 ¹⁾ Motor right parameter set 2 Motor left parameter set 2 ¹⁾ Motor right parameter set 3 Motor left parameter set 3 ¹⁾	Motor right (parameter set 1) no action no action Trip reset
Relay outputs Output 1 Output 2 Output 3 Output 4 Parameterizing options for relay outputs 1 ... 3	no action PAA output 1 PAA output 2 Input 1 Input 2 Input 3 Input 4 Ramp-up Operation/Bypass Ramp-down ON period Command motor on DC braking contactor Group warning Group fault Device error Power on Ready to start	ON period no action no action Group fault
Motor temperature sensor	deactivated Thermoclock PTC type A	deactivated

1) Parameter motor left possible only in conjunction with creep mode.

SIRIUS Soft Starters

For High Feature Applications

SIRIUS 3RW44 soft starters

3

Type		3RW44 ...-BC.4	3RW44 ...-BC.5	3RW44 ...-BC.6
Power electronics				
Rated operating voltage for inline circuit	V	AC 200 ... 460	AC 400 ... 600	AC 400 ... 690
Tolerance	%	-15/+10	-15/+10	-15/+10
Rated operating voltage for inside-delta circuit	V	AC 200 ... 460	AC 400 ... 600	AC 400 ... 600
Tolerance	%	-15/+10	-15/+10	-15/+10
Rated frequency	Hz	50 ... 60		
Tolerance	%	±10		
Continuous operation at 40 °C (% of I_e)	%	115		
Minimum load (% of I_e)	%	20		
Maximum conductor length between soft starter and motor	m	200		
Permissible installation height	m	2000 (derating from 1000); higher on request ⁴⁾		
Permissible mounting position				
Permissible ambient temperature		0 ... +60; (derating from +40)		
Operation	°C			
Storage	°C	-25 ... +80		
Degree of protection		IP00		

Type		3RW44 22	3RW44 23	3RW44 24	3RW44 25	3RW44 26	3RW44 27
Power electronics							
Rated operating current I_e		29	36	47	57	77	93
Load rating with rated operational current I_e							
• Acc. to IEC and UL/CSA for individual mounting, at 40/50/60 °C, AC-53a	A	29/26/23	36/32/29	47/42/37	57/51/45	77/68/59	93/82/72
Power loss							
• In operation after completed ramp-up with continuous rated operating current (40 °C) approx.	W	8	10	32	36	45	55
• During starting with current limit set to 350 % I_M (40 °C)	W	400	470	600	725	940	1160
Permissible rated motor current and starts per hour							
• Normal starting (Class 5)							
- Rated motor current $I_M^{(1)}$, starting time 5 s	A	29	36	47	57	77	93
- Starts per hour ²⁾	1/h	41	34	41	41	41	41
- Rated motor current $I_M^{*(1)3)}$, starting time 10 s	A	29	36	47	57	77	93
- Starts per hour ²⁾	1/h	20	15	20	20	20	20
• Normal starting (Class 10)							
- Rated motor current $I_M^{(1)}$, starting time 10 s	A	29	36	47	57	77	93
- Starts per hour ²⁾	1/h	20	15	20	20	20	20
- Rated motor current $I_M^{*(1)3)}$, starting time 20 s	A	29	36	47	57	77	93
- Starts per hour ²⁾	1/h	10	6	10	10	8	8
• Normal starting (Class 15)							
- Rated motor current $I_M^{(1)}$, starting time 15 s	A	29	36	47	57	77	93
- Starts per hour ²⁾	1/h	13	9	13	13	13	13
- Rated motor current $I_M^{*(1)3)}$, starting time 30 s	A	29	36	47	57	77	93
- Starts per hour ²⁾	1/h	6	4	6	6	6	6
• For heavy starting (Class 20)							
- Rated motor current $I_M^{(1)}$, starting time 20 s	A	29	36	47	57	73	88
- Starts per hour ²⁾	1/h	10	6	10	10	10	10
- Rated motor current $I_M^{*(1)3)}$, starting time 40 s	A	29	36	47	57	73	88
- Starts per hour ²⁾	1/h	4	2	4	5	1.8	0.8
• For very heavy starting (Class 30)							
- Rated motor current $I_M^{(1)}$, starting time 30 s	A	29	36	44	57	65	77
- Starts per hour ²⁾	1/h	6	4	6	6	6	6
- Rated motor current $I_M^{*(1)3)}$, starting time 60 s	A	29	36	44	57	65	77
- Starts per hour ²⁾	1/h	1.8	0.8	3.3	1.5	2	1
Smallest adjustable operating current I_M	A	5	7	9	11	15	18

- 1) Current limit on soft starter set to 350 % I_M .
- 2) For intermittent duty S4 with ON period = 70 %, $T_u = 40$ °C, individual mounting vertical. The quoted operating frequencies do not apply for automatic mode.
- 3) Maximum adjustable rated motor current I_M , dependent on CLASS setting.

4) Derating chart

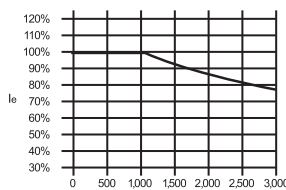

Altitude

The maximum permissible altitude is 3,000 m above sea level.
Fig. : Rated operating current I_e above 1,000 m above sea level.

SIRIUS Soft Starters For High Feature Applications

SIRIUS 3RW44 soft starters

Type		3RW44 34	3RW44 35	3RW44 36
Power electronics				
Rated operating current I_e		113	134	162
Load rating with rated operational current I_e				
• Acc. to IEC and UL/CSA for individual mounting, at 40/50/60 °C, AC-53a	A	113/100/88	134/117/100	162/145/125
Power loss				
• In operation after completed ramp-up with continuous rated operating current (40 °C) approx.	W	64	76	95
• During starting with current limit set to 350 % I_M (40 °C)	W	1350	1700	2460
Permissible rated motor current and starts per hour				
• Normal starting (Class 5)				
- Rated motor current $I_M^{(1)}$, starting time 5 s	A	113	134	162
- Starts per hour ²⁾	1/h	41	39	41
- Rated motor current $I_M^{* (1) (3)}$, starting time 10 s	A	113	134	162
- Starts per hour ²⁾	1/h	20	15	20
• Normal starting (Class 10)				
- Rated motor current $I_M^{(1)}$, starting time 10 s	A	113	134	162
- Starts per hour ²⁾	1/h	20	15	20
- Rated motor current $I_M^{* (1) (3)}$, starting time 20 s	A	113	134	162
- Starts per hour ²⁾	1/h	9	6	7
• Normal starting (Class 15)				
- Rated motor current $I_M^{(1)}$, starting time 15 s	A	113	134	162
- Starts per hour ²⁾	1/h	13	9	12
- Rated motor current $I_M^{* (1) (3)}$, starting time 30 s	A	113	134	162
- Starts per hour ²⁾	1/h	6	6	6
• For heavy starting (Class 20)				
- Rated motor current $I_M^{(1)}$, starting time 20 s	A	106	125	147
- Starts per hour ²⁾	1/h	9	9	10
- Rated motor current $I_M^{* (1) (3)}$, starting time 40 s	A	106	125	147
- Starts per hour ²⁾	1/h	1.5	2	0.5
• For very heavy starting (Class 30)				
- Rated motor current $I_M^{(1)}$, starting time 30 s	A	91	110	120
- Starts per hour ²⁾	1/h	6	6	6
- Rated motor current $I_M^{* (1) (3)}$, starting time 60 s	A	91	110	120
- Starts per hour ²⁾	1/h	2	2	0.5
Smallest adjustable operating current I_M	A	22	26	32

1) Current limit on soft starter set to 350 % I_M .

2) For intermittent duty S4 with ON period = 70 %, $T_{ij} = 40$ °C, individual mounting vertical. The quoted operating frequencies do not apply for automatic mode.

3) Maximum adjustable rated motor current I_M , dependent on CLASS setting.

SIRIUS Soft Starters

For High Feature Applications

SIRIUS 3RW44 soft starters

3

Type		3RW44 43	3RW44 44	3RW44 45	3RW44 46	3RW44 47
Power electronics						
Rated operating current I_e		203	250	313	356	432
Load rating with rated operating current I_e						
• Acc. to IEC and UL/CSA for individual mounting, at 40/50/60 °C, AC-53a	A	203/180/156	250/215/185	313/280/250	356/315/280	432/385/335
Power loss						
• In operation after completed ramp-up with continuous rated operating current (40 °C) approx.	W	89	110	145	174	232
• During starting with current limit set to 350 % I_M (40 °C)	W	3350	4000	4470	5350	5860
Permissible rated motor current and starts per hour						
• Normal starting (Class 5)						
- Rated motor current $I_M^{1)}$, starting time 5 s	A	203	250	313	356	432
- Starts per hour ²⁾	1/h	41	40	41	41	39
- Rated motor current $I_M^{* 1) 3)}$, starting time 10 s	A	203	250	313	356	432
- Starts per hour ²⁾	1/h	20	20	20	17	16
• Normal starting (Class 10)						
- Rated motor current $I_M^{1)}$, starting time 10 s	A	203	250	313	356	432
- Starts per hour ²⁾	1/h	20	20	20	17	16
- Rated motor current $I_M^{* 1) 3)}$, starting time 20 s	A	203	250	313	356	432
- Starts per hour ²⁾	1/h	10	8	8	4	5
• Normal starting (Class 15)						
- Rated motor current $I_M^{1)}$, starting time 15 s	A	203	240	313	325	402
- Starts per hour ²⁾	1/h	13	11	13	13	11
- Rated motor current $I_M^{* 1) 3)}$, starting time 30 s	A	203	240	313	325	402
- Starts per hour ²⁾	1/h	6	6	6	6	6
• For heavy starting (Class 20)						
- Rated motor current $I_M^{1)}$, starting time 20 s	A	195	215	275	285	356
- Starts per hour ²⁾	1/h	10	10	10	10	10
- Rated motor current $I_M^{* 1) 3)}$, starting time 40 s	A	195	215	275	285	356
- Starts per hour ²⁾	1/h	4	1.5	3	3	1.8
• For very heavy starting (Class 30)						
- Rated motor current $I_M^{1)}$, starting time 30 s	A	162	180	220	240	285
- Starts per hour ²⁾	1/h	6	6	6	6	6
- Rated motor current $I_M^{* 1) 3)}$, starting time 60 s	A	162	180	220	240	285
- Starts per hour ²⁾	1/h	4.3	1.8	3	2	1.6
Smallest adjustable operating current I_M	A	40	50	62	71	86

1) Current limit on soft starter set to 350 % I_M .







2) For intermittent duty S4 with ON period = 70 %, $T_u = 40$ °C, individual mounting vertical. The quoted operating frequencies do not apply for automatic mode.

3) Maximum adjustable rated motor current I_M , dependent on CLASS setting.

SIRIUS Soft Starters For High Feature Applications

SIRIUS 3RW44 soft starters

3

Type		3RW44 2.	3RW44 3., 3RW44 4.	
Conductor cross-sections				
Screw terminals with box terminal front clamping point connected 	Main conductor: <ul style="list-style-type: none"> finely stranded with end sleeve finely stranded without end sleeve stranded ribbon cable conductors (number x width x thickness) AWG conductor, solid or stranded 	3RT19 55-4G (55 kW) mm ² 16 ... 70 mm ² 16 ... 70 mm ² 16 ... 70 mm min. 3 x 9 x 0.8, max. 6 x 15.5 x 0.8 AWG 6 ... 2/0	3RT19 66-4G mm ² 70 ... 240 mm ² 70 ... 240 mm ² 95 ... 300 mm min. 6 x 9 x 0.8, max. 20 x 24 x 0.5 3/0 ... 600 kcmil	
	rear clamping point connected 	<ul style="list-style-type: none"> finely stranded with end sleeve finely stranded without end sleeve stranded ribbon cable conductors (number x width x thickness) AWG conductor, solid or stranded 	mm ² 16 ... 70 mm ² 16 ... 70 mm ² 16 ... 70 mm min. 3 x 9 x 0.8, max. 6 x 15.5 x 0.8 AWG 6 ... 2/0	mm ² 120 ... 185 mm ² 120 ... 185 mm ² 120 ... 240 mm min. 6 x 9 x 0.8, max. 20 x 24 x 0.5 250 ... 500 kcmil
	both clamping points connected 	<ul style="list-style-type: none"> finely stranded with end sleeve finely stranded without end sleeve stranded ribbon cable conductors (number x width x thickness) AWG conductor, solid or stranded terminal screws - Pickup torque 	mm ² max. 1 x 50, 1 x 70 mm ² max. 1 x 50, 1 x 70 mm ² max. 2 x 70 mm max. 2 x (6 x 15.5 x 0.8) AWG max. 2 x 1/0 M10 (hexagon socket, A/F4) 10 ... 12 90 ... 110	mm ² min. 2 x 50; max. 2 x 185 mm ² min. 2 x 50; max. 2 x 185 mm ² max. 2 x 70; max. 2 x 240 mm max. 2 x (20 x 24 x 0.5) min. 2 x 2/0; max. 2 x 500 kcmil M12 (hexagon socket, A/F5) 20 ... 22 180 ... 195
Screw terminals with box terminal front or rear clamping point connected  	Main conductor: <ul style="list-style-type: none"> finely stranded with end sleeve finely stranded without end sleeve stranded ribbon cable conductors (number x width x thickness) AWG conductor, solid or stranded 	3RT19 56-4G mm ² 16 ... 120 mm ² 16 ... 120 mm ² 16 ... 120 mm min. 3 x 9 x 0.8, max. 6 x 15.5 x 0.8 AWG 6 ... 250 kcmil		
	both clamping points connected 	<ul style="list-style-type: none"> finely stranded with end sleeve finely stranded without end sleeve stranded ribbon cable conductors (number x width x thickness) AWG conductor, solid or stranded 	mm ² max. 1 x 95, 1 x 120 mm ² max. 1 x 95, 1 x 120 mm ² max. 2 x 120 mm max. 2 x (10 x 15.5 x 0.8) AWG max. 2 x 3/0	
Screw terminals	Main conductor: <u>Without box terminal/rail connection</u> <ul style="list-style-type: none"> finely stranded with cable lug stranded with cable lug AWG conductor, solid or stranded connecting bar (max. width) terminal screws - pickup torque 	mm ² 16 ... 95 ¹⁾ mm ² 25 ... 120 ¹⁾ AWG 4 ... 250 kcmil mm 17 Nm M8 x 25 (A/F13) lb.in 10 ... 14 89 ... 124	mm ² 50 ... 240 ²⁾ mm ² 70 ... 240 ²⁾ 2/0 ... 500 kcmil 25 M10 x 30 (A/F17) 14 ... 24 124 ... 210	

1) When connecting cable lugs to DIN 46235 use 3RT19 56-4EA1 terminal cover for conductor cross-sections from 95 mm² to ensure phase spacing.

2) When connecting cable lugs to DIN 46234, the 3RT19 66-4EA1 terminal cover must be used for conductor cross-sections of 240 mm² and more as well as DIN 46235 for conductor cross-sections of 185 mm² and more to keep the phase clearance.

Soft starter	Type	3RW40 ..
Conductor cross-sections		
Auxiliary conductors (1 or 2 conductors can be connected):		
Screw terminals		
<ul style="list-style-type: none"> solid finely stranded with end sleeve 	mm ² 2 x 0.5 ... 2.5 mm ² 2 x 0.5 ... 1.5	
<ul style="list-style-type: none"> AWG cables - solid or stranded finely stranded with end sleeve 	AWG 2 x 20 ... 14 AWG 2 x 20 ... 16	
<ul style="list-style-type: none"> terminal screws - pickup torque 	Nm 0.7 ... 0.9 lb.in 7 ... 8	
Spring-loaded terminals		
<ul style="list-style-type: none"> solid finely stranded with end sleeve AWG conductor, solid or stranded 	mm ² 2 x 0.25 ... 2.5 mm ² 2 x 0.25 ... 1.5 AWG 2 x 24 ... 14	

SIRIUS Soft Starters

For High Feature Applications

SIRIUS 3RW44 soft starters

3

	Standard	Parameters
Electromagnetic compatibility acc. to EN 60947-4-2		
<i>EMC interference immunity</i>		
Electrostatic discharge (ESD)	EN 61000-4-2	±4 kV contact discharge, ±8 kV air discharge
Electromagnetic RF fields	EN 61000-4-3	Frequency range: 80 ... 1000 MHz with 80 % at 1 kHz Degree of severity 3, 10 V/m
Conducted RF interference	EN 61000-4-6	Frequency range: 150 kHz ... 80 MHz with 80 % at 1 kHz Interference 10 V
RF voltages and RF currents on conductors Burst Surge	EN 61000-4-4 EN 61000-4-5	±2 kV/5 kHz ±1 kV line to line ±2 kV line to ground
<i>EMC interference emission</i>		
EMC interference field strength	EN 55011	Limit value of Class A at 30 ... 1000 MHz
Radio interference voltage	EN 55011	Limit value of Class A at 0.15 ... 30 MHz
<i>Is an RI suppression filter necessary?</i>		
Degree of noise suppression A (industrial applications)	no	Limit value of Class A at 0.15 ... 30 MHz
Vibration	IEC 68-2-6	10...57 Hz (Constant amplitude) 0.15 mm) 58...150 Hz (Constant acceleration) 2 g)
Short Circuit	3RW442 3RW443 3RW444	10 kA, 600 V AC, max. Fuse 300 A 10 kA, 600 V AC, max. Fuse 450 A 30 kA, 600 V AC, max. Fuse 1200 A

Characteristic curves

Motor protection tripping characteristic curves for 3RW44 (with symmetry)

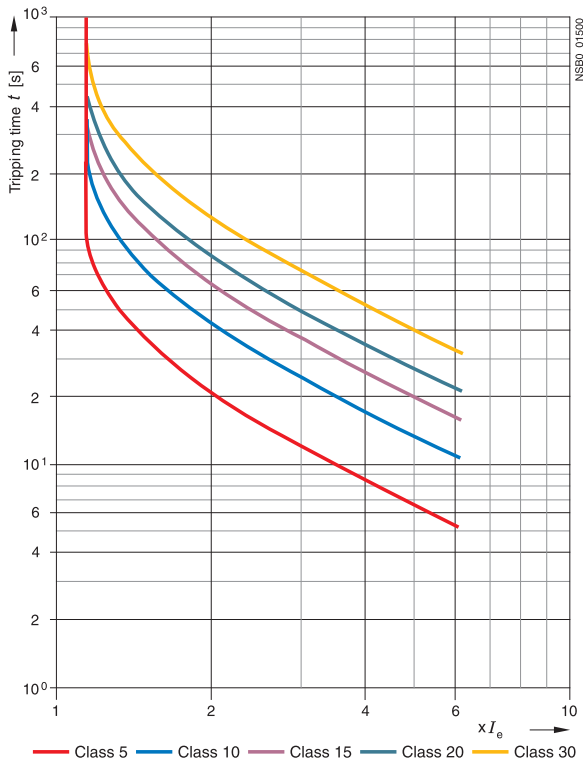

Dimensional drawings

3RW44 ..

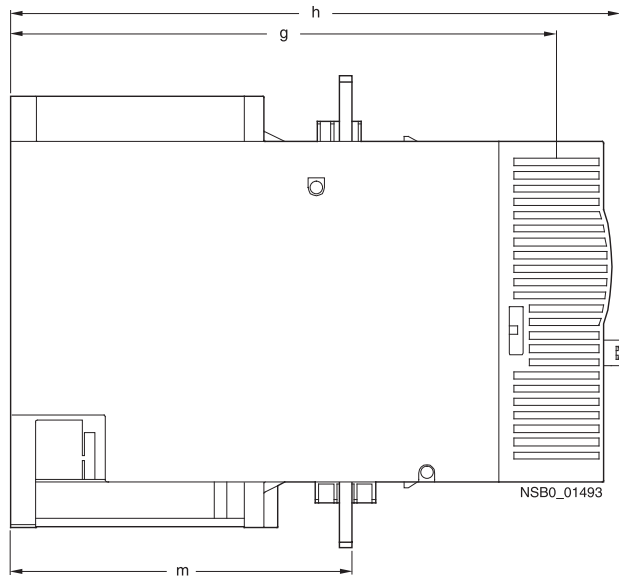
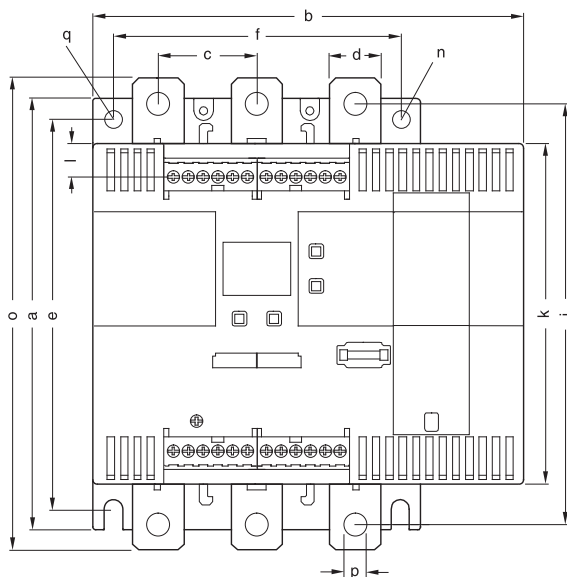

Type/Dimension (mm)	a	b	c	d	e	f	g	h	i	k	l	m	n	o	p	q
3RW44 2.	180	170	37	11	167	100	240	270	180	148	7.5	153	7	184	6.6	M6, 10 Nm
3RW44 3.	180	170	37	17	167	100	240	270	180	148	7.5	153	7	198	9	M6, 10 Nm
3RW44 4.	210	210	48	25	190	140	269	298	205	166	16	166	9	230	11	M8, 15 Nm

SIRIUS Soft Starters

For High Feature Applications

SIRIUS 3RW44 soft starters

Schematics

Connection examples for main and control circuits

Main circuit

Possibility 1a:
Inline circuit with circuit-breaker and SITOR fuse
(semiconductor protection only)

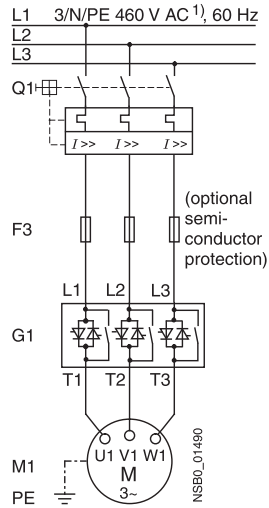

Control circuit

Possibility 1:
Control by pushbutton

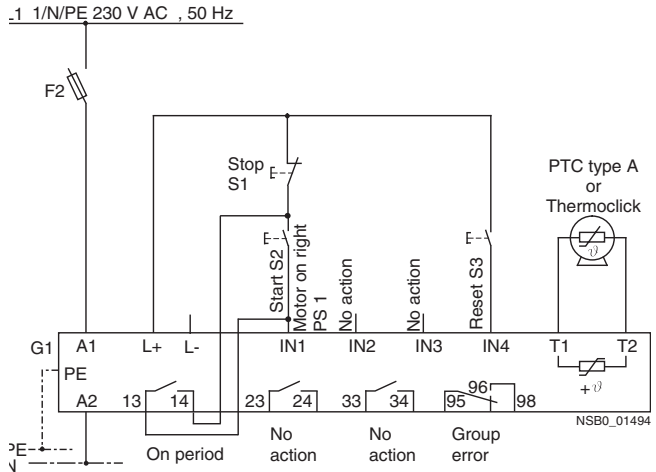

Main circuit

Possibility 1b:
Inline circuit with full-range protection
(line and semiconductor protection)

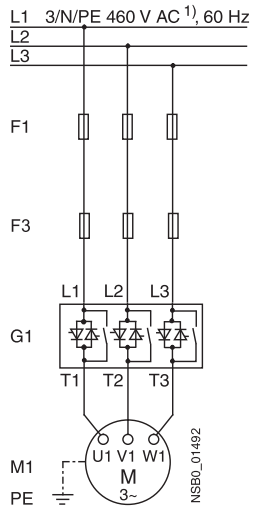

Possibility 1c:
Inline circuit with line and SITOR fuse
(semiconductor protection only)

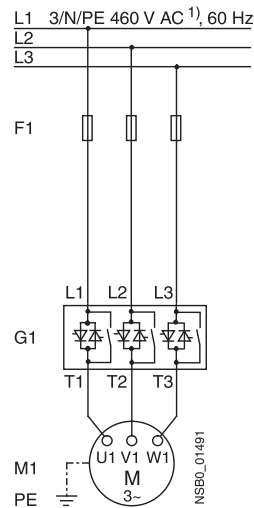

1) Permissible values for main and control voltage, see Technical Information, page 3/19 to 3/30.

SIRIUS Soft Starters For High Feature Applications

SIRIUS 3RW44 soft starters

3

Main circuit

Possibility 2:
Inline circuit with main contactor

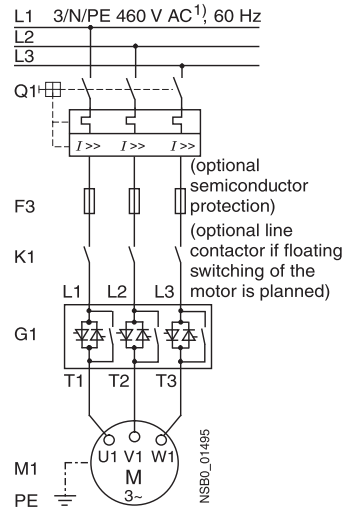

Control circuit

Possibility 2:
Control of a main contactor and control by means of PLC

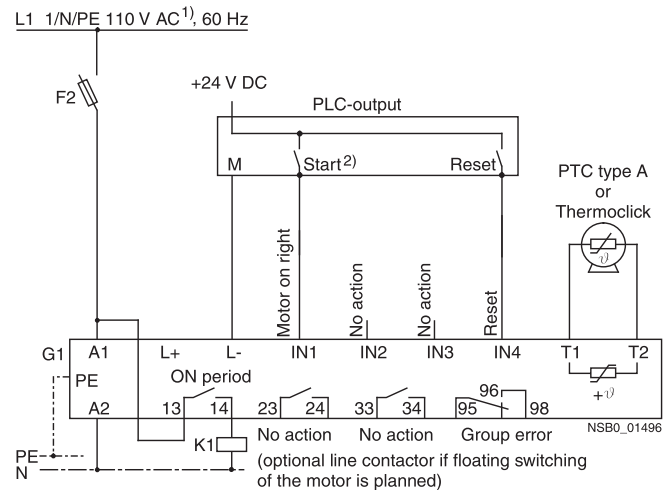

1) Permissible values for main and control voltage, see Technical Information, page 3/19 to 3/30.

2) Caution. Risk of restarting!

The start command (e.g. from the PLC) must be reset prior to a reset command because a new, automatic restart will take place automatically if a start command is active after the reset command. This applies especially in case of motor protection tripping.

For safety reasons we recommend incorporating the group error output (terminals 95 and 96) in the controller.

SIRIUS Soft Starters For High Feature Applications

SIRIUS 3RW44 soft starters

3

Main circuit

Possibility 3a:
Inline circuit with ramp-down function DC braking³⁾
(for device types 3RW44 22 to 3RW44 25)

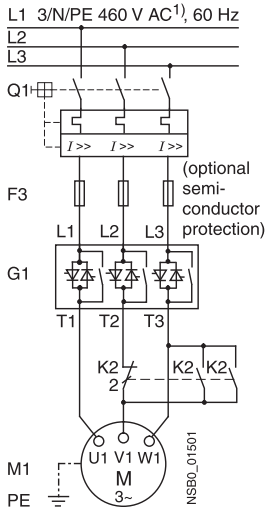

Control circuit

Possibility 3a:
Control of the braking contactor³⁾

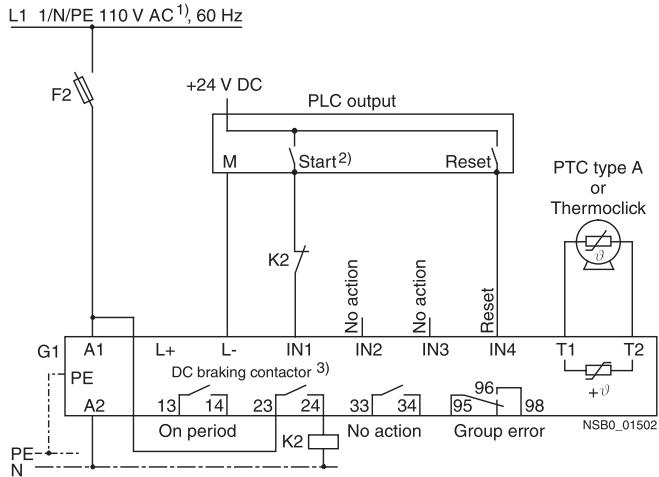

Main circuit

Possibility 3b:
Inline circuit with ramp-down function DC braking³⁾
(for device types 3RW44 26 to 3RW44 47)

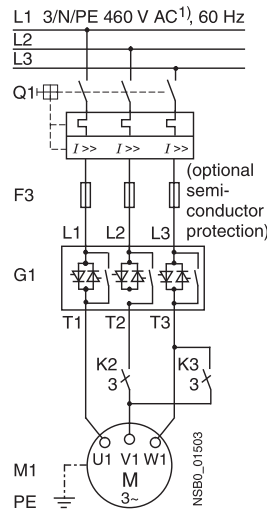

Control circuit

Possibility 3b:
Control of the braking contactor³⁾

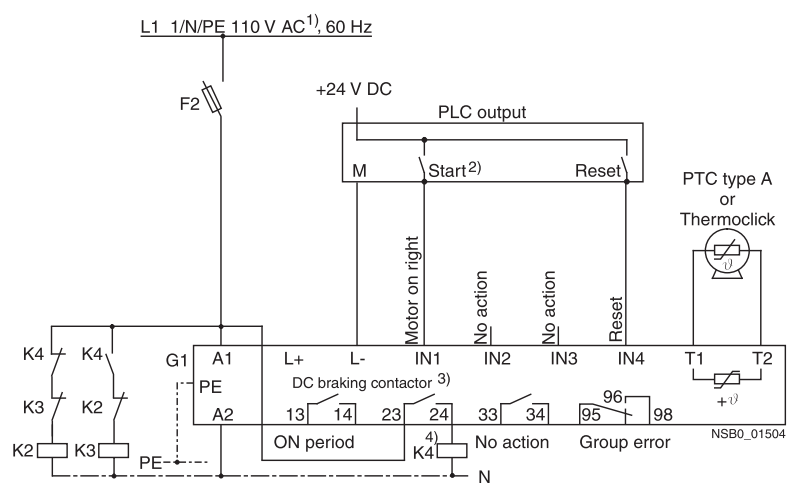

1) Permissible values for main and control voltage, see Technical Information, page 3/19 to 3/30.

2) Caution. Risk of restarting!

The start command (e.g. from the PLC) must be reset prior to a reset command because a new, automatic restart will take place automatically if a start command is active after the reset command. This applies especially in case of motor protection tripping.
For safety reasons we recommend incorporating the group error output (terminals 95 and 96) in the controller.

3) If the ramp-down function "Combined braking" is selected, no braking contactor is required.

If the ramp-down function "DC braking" is selected, a braking contactor must be used in addition. Type, see the table "Component design feeder (inline circuit)" on page 3/26.
For applications with large centrifugal masses ($J_{Load} > J_{Motor}$) we recommend the function "DC braking".
The output 2 must be switched over to "DC braking contactor".

4) Auxiliary relay K4, e.g.:

LZX:RT4A4T30 (230 V AC rated control supply voltage),
LZX:RT4A4S15 (115 V AC rated control supply voltage).

SIRIUS Soft Starters For High Feature Applications

SIRIUS 3RW44 soft starters

Main circuit

Possibility 4a:
Inside-delta circuit

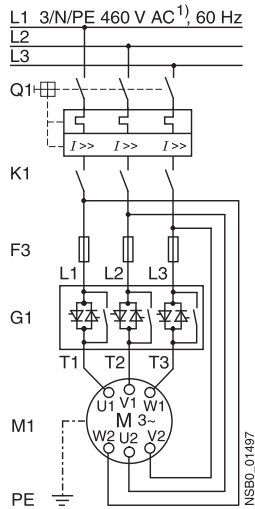

Possibility 4b:
Change of direction of rotation for
inside-delta circuit

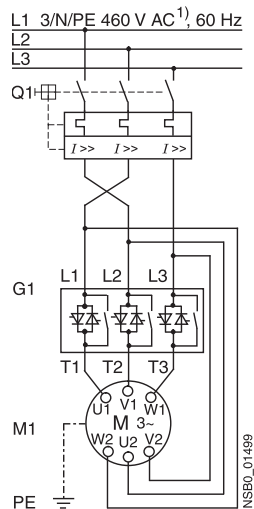

Control circuit

Possibility 4:
Control by means of PLC

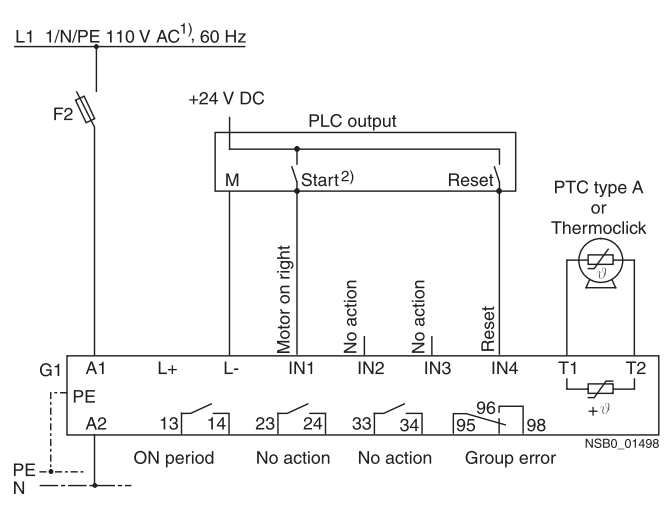

1) Permissible values for main and control voltage, see Technical Information, page 3/19 to 3/30.

2) Caution. Risk of restarting!

The start command (e.g. from the PLC) must be reset prior to a reset command because a new, automatic restart will take place automatically if a start command is active after the reset command. This applies especially in case of motor protection tripping. For safety reasons we recommend incorporating the group error output (terminals 95 and 96) in the controller.

SIRIUS Soft Starters For High Feature Applications

SIRIUS 3RW44 soft starters

3

More information

Application examples for normal starting (Class 10)

Normal starting Class 10 (up to 20 s with 350 % $I_{n\ motor}$).

The soft starter rating can be selected to be as high as the rating of the motor used

Application	Conveyor belt	Roller conveyor	Compressor	Small ventilator	Pump	Hydraulic pump
Starting parameters						
• Voltage ramp and current limiting						
- Starting voltage	% 70	60	50	30	30	30
- Starting time	s 10	10	10	10	10	10
- Current limit value	deactivated	deactivated	$4 \times I_M$	$4 \times I_M$	deactivated	deactivated
• Torque ramp						
- Starting torque	60	50	40	20	10	10
- End torque	150	150	150	150	150	150
- Starting time	10	10	10	10	10	10
• Breakaway pulse						
	deactivated (0 ms)	deactivated (0 ms)	deactivated (0 ms)	deactivated (0 ms)	deactivated (0 ms)	deactivated (0 ms)
Ramp-down mode	Smooth ramp-down	Smooth ramp-down	Free ramp-down	Free ramp-down	Pump ramp-down	Free ramp-down

Application examples for normal starting (Class 20)

Heavy starting Class 20 (up to 40 s with 350 % $I_{n\ motor}$).

The soft starter has to be selected one rating class higher than the motor used

Application	Agitator	Centrifuge	Milling machine
Starting parameters			
• Voltage ramp and current limiting			
- Starting voltage	% 30	30	30
- Starting time	s 30	30	30
- Current limit value	$4 \times I_M$	$4 \times I_M$	$4 \times I_M$
• Torque ramp			
- Starting torque	30	30	30
- End torque	150	150	150
- Starting time	30	30	30
• Breakaway pulse			
	deactivated (0 ms)	deactivated (0 ms)	deactivated (0 ms)
Ramp-down mode	Free ramp-down	Free ramp-down	Free ramp-down or DC braking

Application examples for very heavy starting (Class 30)

Very heavy starting Class 30 (up to 60 s with 350 % $I_{n\ motor}$).

The soft starter has to be selected two rating classes higher than the motor used

Application	Large ventilator	Mill	Breaker	Circular saw/bandsaw
Starting parameters				
• Voltage ramp and current limiting				
- Starting voltage	% 30	50	50	30
- Starting time	s 60	60	60	60
- Current limit value	$4 \times I_M$	$4 \times I_M$	$4 \times I_M$	$4 \times I_M$
• Torque ramp				
- Starting torque	20	50	50	20
- End torque	150	150	150	150
- Starting time	60	60	60	60
• Breakaway pulse				
	deactivated (0 ms)	80 %; 300 ms	80 %; 300 ms	deactivated (0 ms)
Ramp-down mode	Free ramp-down	Free ramp-down	Free ramp-down	Free ramp-down

Note:

These tables present sample setting values which are intended only for the purposes of information and are not binding. The setting values depend on the application in question and must be optimized during commissioning.

The soft starter dimensions should be checked where necessary with the Win-SOFTSTARTER software or with the help of Technical Assistance.

SIRIUS Soft Starters For High Feature Applications

SIRIUS 3RW44 soft starters

3

Circuit concept

The SIRIUS 3RW44 soft starters can be operated in two different types of circuit.

- **Inline circuit**
The switching devices for isolating and protecting the motor are simply connected in series with the soft starter. The motor is connected to the soft starter with three leads.
- **Inside-delta circuit**
The wiring is similar to that of wye-delta starters. The phases of the soft starter are connected in series with the individual motor windings. The soft starter then only has to carry the phase current, amounting to about 58 % of the rated current of the motor (conductor current).

Comparison of the types of circuit

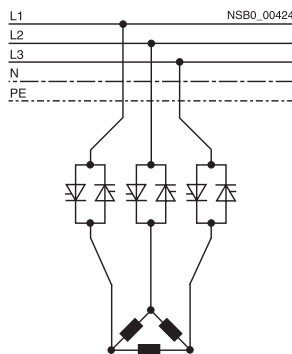

Inline circuit:
Rated current I_a corresponds to the rated motor current I_n ,
3 conductors to motor

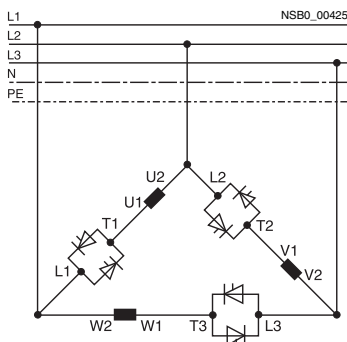

Inside-delta circuit:
Rated current I_a corresponds to approx. 58 % of the rated motor
current I_n ,
6 conductors to motor (as star delta starters)

Which circuit?

Using the inline circuit involves the lowest wiring complexity. If the soft starter to motor connections are long, this contact sequence is preferable. With the inside-delta circuit there is double the wiring complexity but a smaller size of device can be used at the same rating.

Thanks to the possibility of switching between the inline circuit and inside-delta circuit, the most favorable solution can always be chosen.

The braking function is possible only in the inline circuit.

Configuring

The 3RW44 solid-state starters are designed for normal starting. In case of heavy starting or increased starting frequency, a larger unit must be selected.

For long starting times it is recommended to have a PTC thermistor detector in the motor. This also applies for the ramp-down modes soft ramp-down, pump ramp-down and DC braking, because during the ramp-down time in these modes, an additional current loading applies in contrast to free ramp-down.

In the motor feeder between the soft starter and the motor, no capacitive elements are permitted (e.g. compensation equipment). Active filters are not allowed to be used in connection with soft starters.

All elements of the main circuit (such as fuses and switching devices) should be dimensioned for direct starting, following the local short-circuit conditions. Fuses, switching devices and overload relays must be ordered separately.

The harmonic component load for starting currents must be taken into consideration for the selection of circuit-breakers (selection of release).

Serial PC interface RS 232 and parameterizing and operating software Softstarter ES

The solid-state 3RW44 soft starters have a PC interface for communicating with the Softstarter ES smart software and an operating and monitoring module.

Manual for SIRIUS 3RW44

Besides containing all important information on planning, commissioning and servicing, the manual also contains suggested circuits and the technical data for all devices.

Win-SOFTSTARTER selection and simulation program

With this software, you can simulate and select all Siemens soft starters, taking into account various parameters such as mains properties, motor and load data, and special application requirements.

The software is a valuable tool, which makes complicated, lengthy manual calculations for determining the required soft starters superfluous.

SIRIUS Soft Starters

Notes

3

SIRIUS Soft Starters

Notes

3

SIRIUS Soft Starters

Notes

3