

Instruction Manual

Installation • Operation • Maintenance

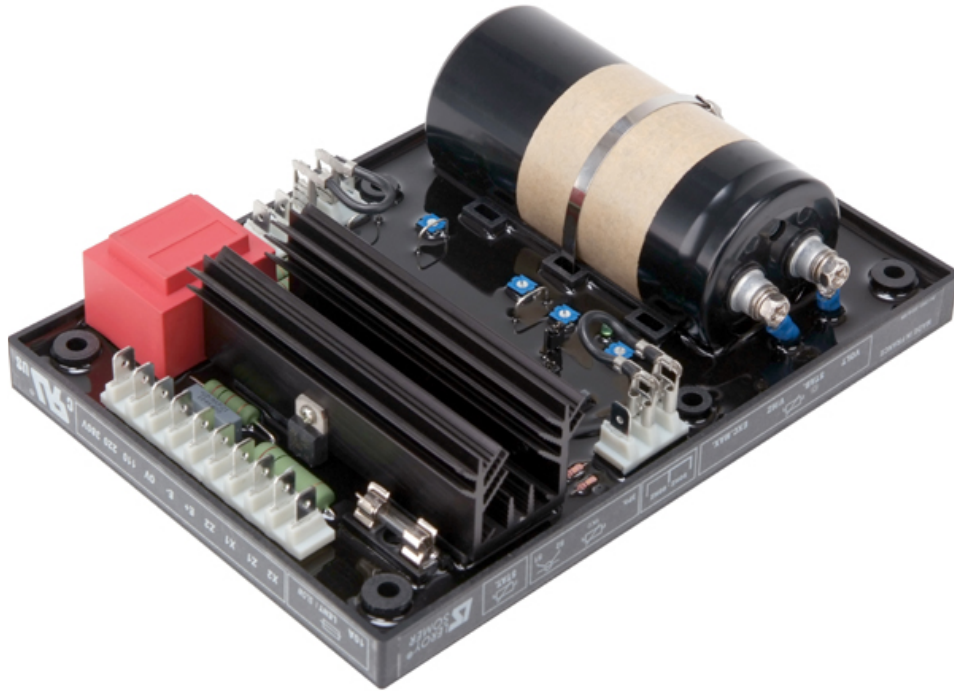

Voltage Regulator AVR R448

Ruitai industry Co.,Ltd.
Tel: +86 577 56784310
Fax: +86 577 56667563
Email: sales@china-avr.com
www.china-avr.com

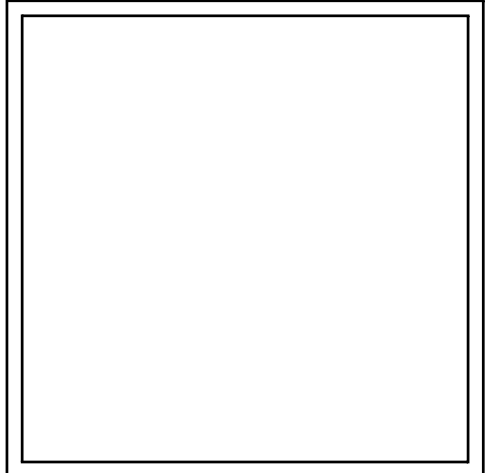
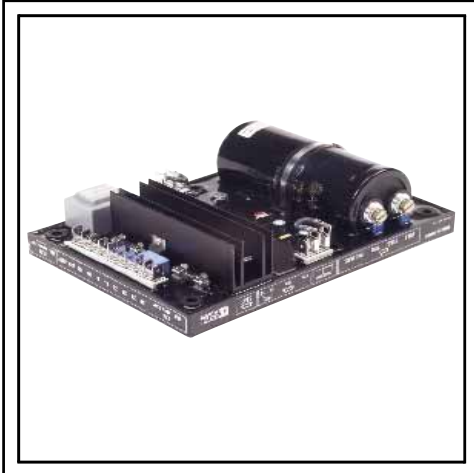

*This manual is to be given to
the end user*

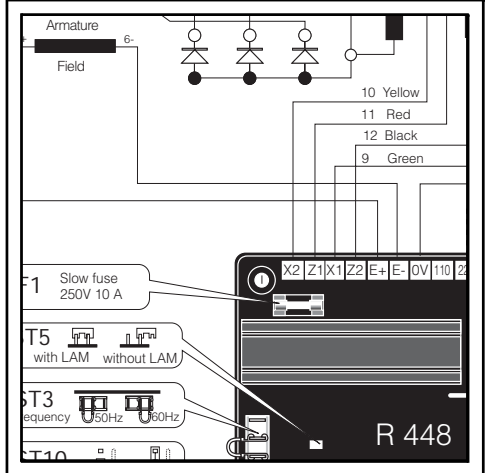

R448 & R448 V50

A.V.R.

Installation and maintenance

R448 & R448 V50

A.V.R.

This manual concerns the alternator A.V.R. which you have just purchased.

We wish to draw your attention to the contents of this maintenance manual. By following certain important points during installation, use and servicing of your A.V.R., you can look forward to many years of trouble-free operation.

SAFETY MEASURES

Before using your machine for the first time, it is important to read the whole of this installation and maintenance manual.

All necessary operations and interventions on this machine must be performed by a qualified technician.

Our technical support service will be pleased to provide any additional information you may require.

The various operations described in this manual are accompanied by recommendations or symbols to alert the user to potential risks of accidents. It is vital that you understand and take notice of the following warning symbols.

WARNING

Warning symbol for an operation capable of damaging or destroying the machine or surrounding equipment.



Warning symbol for general danger to personnel.



Warning symbol for electrical danger to personnel.

Note: LEROY-SOMER reserves the right to modify the characteristics of its products at any time in order to incorporate the latest technological developments. The information contained in this document may therefore be changed without notice.

R448 & R448 V50

A.V.R.

CONTENTS

1 - GENERAL INFORMATION.....	5
1.1 - Description.....	5
1.2 - Identification.....	
2 - SUPPLY	5
2.1 - AREP excitation system	5
2.2 - PMG excitation system	6
2.3 - SHUNT or separate excitation system.....	7
3 - R448 A.V.R.	8
3.1 - Characteristics	8
3.2 - Frequency compared with voltage (without LAM).....	8
3.3 - LAM (Load Acceptance Module) characteristics	8
3.4 - Typical effects of the LAM with a diesel engine with or without a LAM (U/F only).....	9
3.5 - R448 A.V.R. options	9
4 - INSTALLATION - COMMISSIONING	11
4.1 - Electrical checks on the AVR.....	11
4.2 - Settings.....	11
4.3 - Electrical faults.....	14
5 - SPARE PARTS	15
5.1 - Designation.....	15
5.2 - Technical support service	15



All such operations performed on the A.V.R. should be undertaken by personnel trained in the commissioning, servicing and maintenance of electrical and mechanical components.

Copyright 2005 : MOTEURS LEROY-SOMER

This document is the property of :
MOTEURS LEROY-SOMER

It may not be reproduced in any form without prior authorization.
All brands and models have been registered and patents applied for.

R448 & R448 V50

A.V.R.

1 - GENERAL INFORMATION

1.1 - Description

The A.V.R. R 448 V50 is delivered in a box designed to be mounted on a panel with suspension.

Connexions are made with «Faston» connectors.

- Operating temperature: - 30°C to +70°C
- Storage temperature: - 55°C to + 85°C
- Shocks on the base: 9g for the 3 axis
- Vibrations: Less than 10Hz: 2mm half peak amplitude
10Hz to 100Hz: 100mm/s, above 100Hz: 8g

1.2 - Identification

These 2 A.V.R.s have strictly identical characteristics and dimensions, the following details distinguish the V50:

- an adjuster dedicated to the alternator LSA 50.2,
- the elimination of the ST6 jumper (A)
- a white serigraphy (B)
(blue for R 448),
- a label stipulating the type of alternator (C).

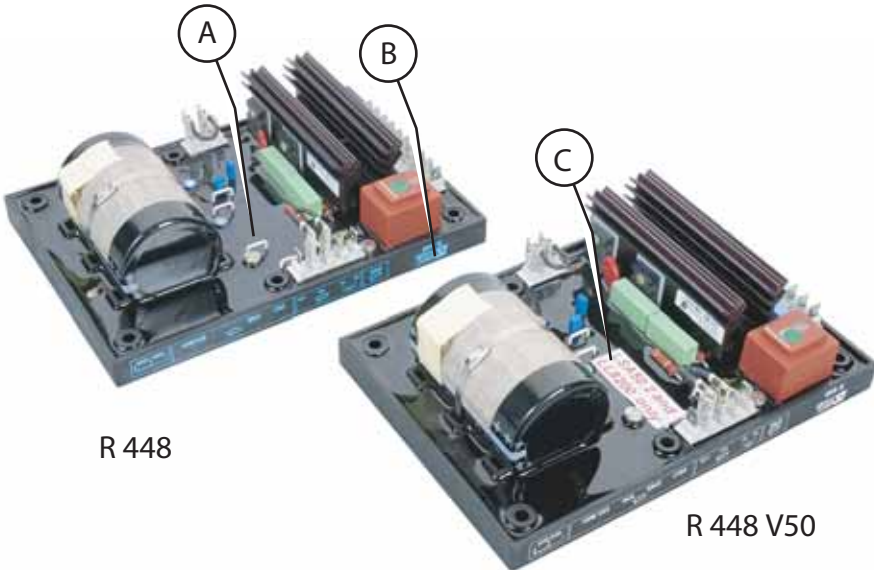

R448 & R448 V50**A.V.R.****2 - SUPPLY****2.1 - AREP excitation system**

For both AREP & PMG excitation systems, the alternator voltage regulator is the R 448.

With **AREP** excitation, the R 448 electronic AVR is powered by two auxiliary windings which are independent of the voltage match circuit.

The first winding has a voltage in proportion to that of the alternator (characteristic Shunt), the second has a voltage in proportion to the stator current (compound characteristic: Booster effect).

The power supply voltage is rectified and filtered before being used by the AVR monitoring transistor.

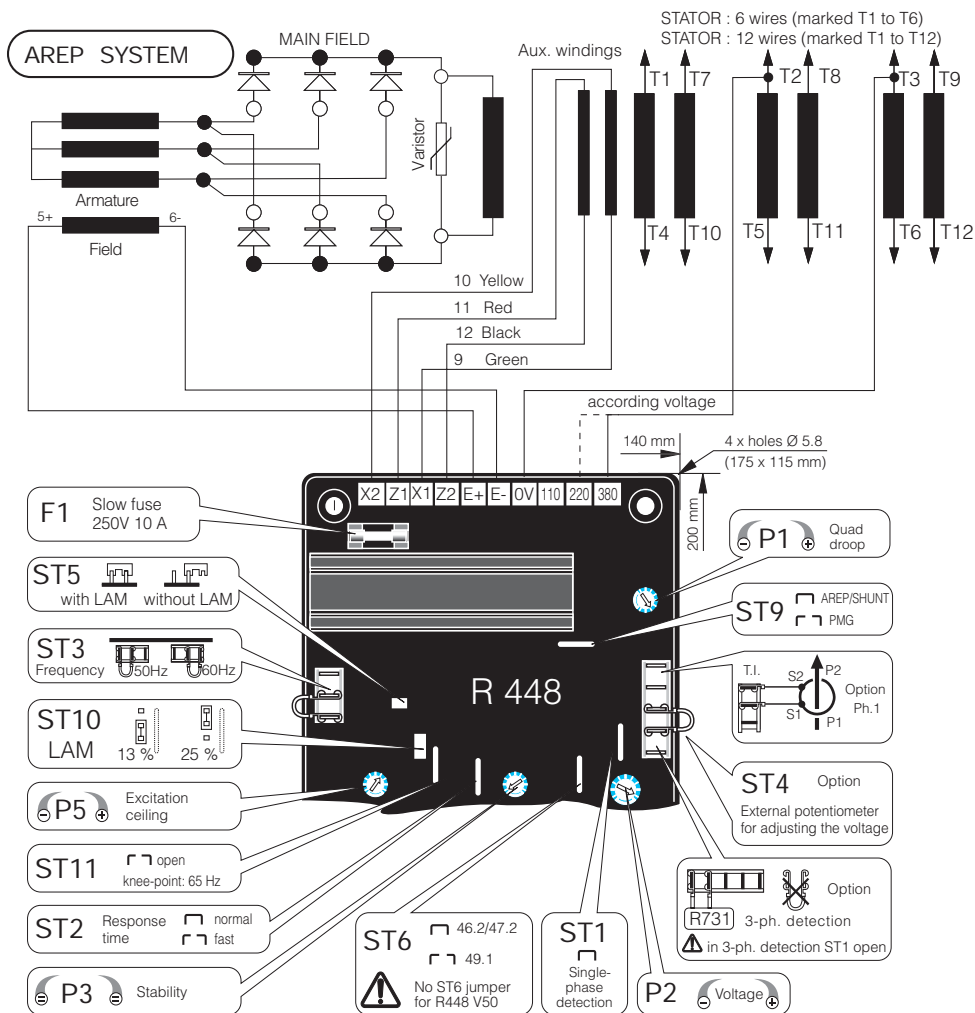

R448 & R448 V50 A.V.R.

2.2 - PMG excitation system

With **PMG** excitation, a permanent magnet generator (PMG) added to the alternator supplies the AVR with voltage which is independent of the main alternator winding. This is fitted at the rear of the machine and connected to the R 448 AVR, and the ST9

jumper must be disconnected.

These two principles provide the machine with a short-circuit current capacity of 3 IN for 10 s, and good immunity to distortions generated by the load.

The AVR monitors and corrects the alternator output voltage by adjusting the excitation current.

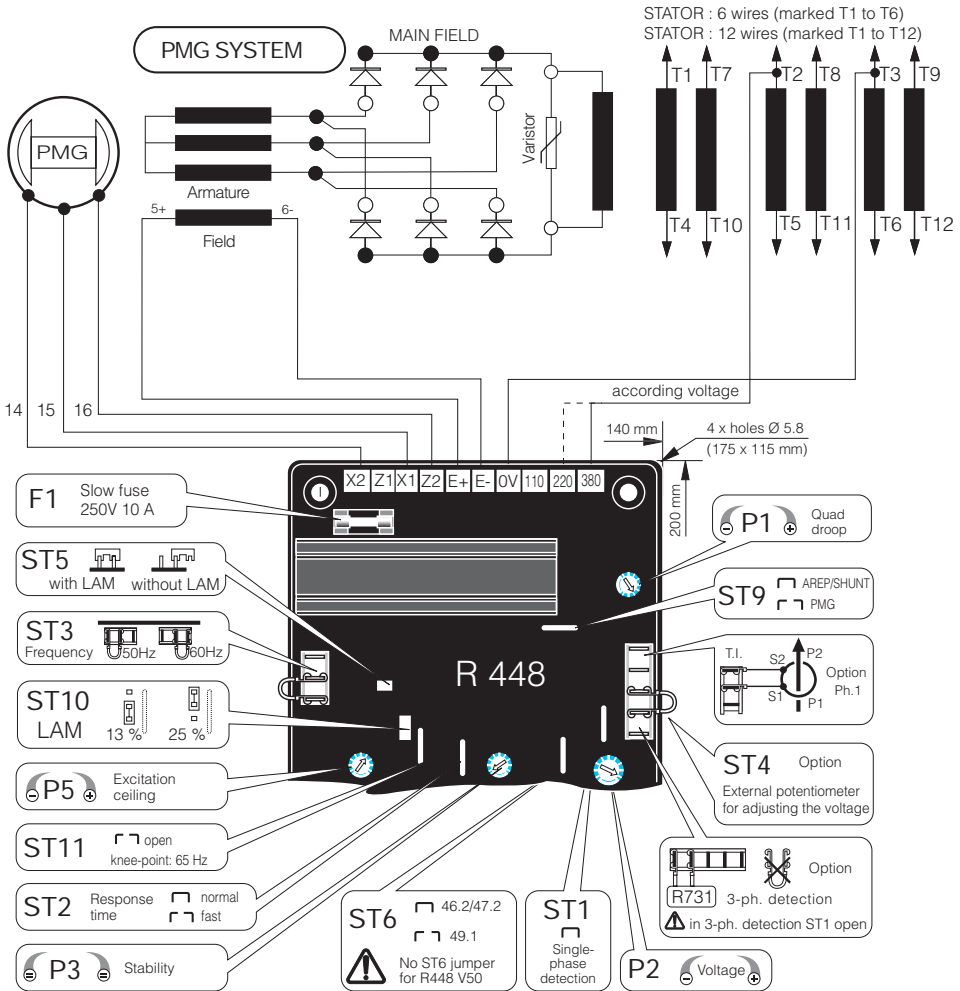

R448 & R448 V50 A.V.R.

2.3 - SHUNT or separate excitation system

In SHUNT excitation, R 448 A.V.R. is supplied by main windings (140V - 50/60 Hz) to X1, X2.

The new functions are :

- Parallel operation between alternators with C.T.
- Parallel operation with the mains with C.T. and R 726 module

- 3-phase sensing (R 731 module)
- LAM function integrated in the R 448 AVR.

In this case of LSA 42.2, A.V.R. and module(s) must be installed in the external control panel.

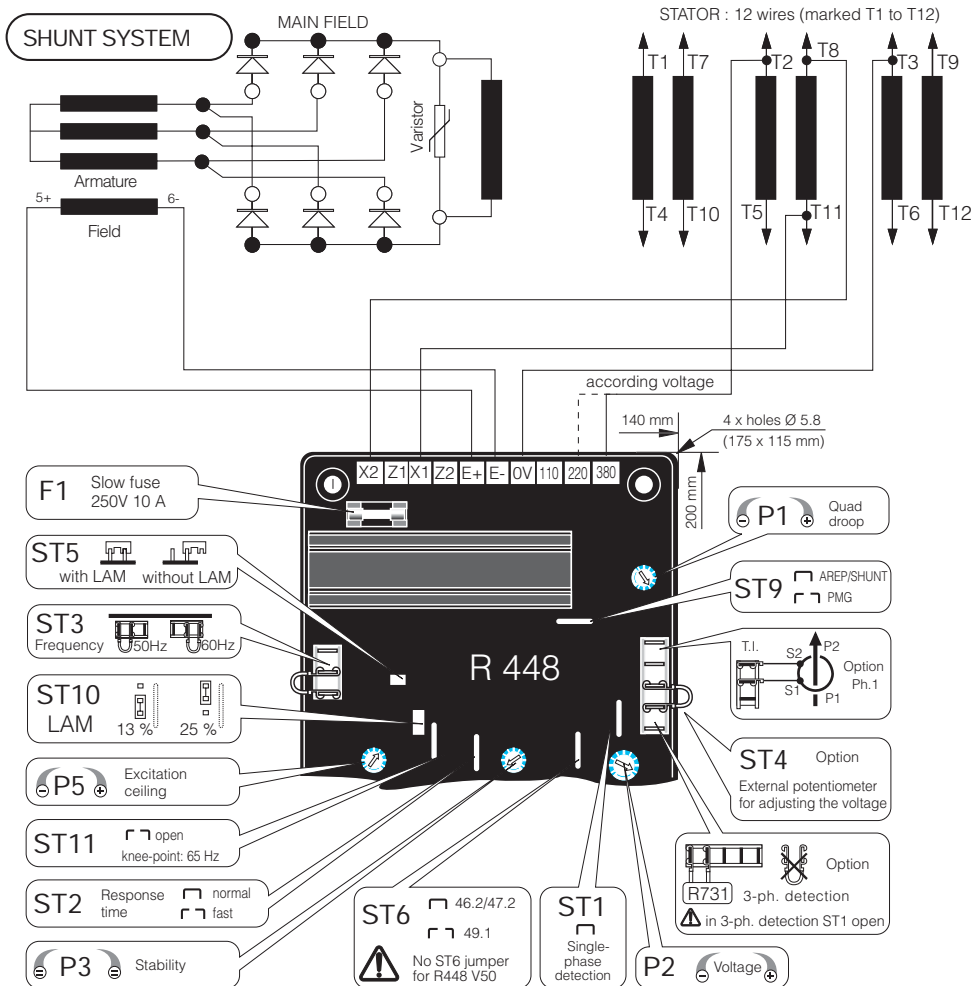

R448 & R448 V50

A.V.R.

3 - R448 A.V.R.

3.1 - Characteristics

- Shunt power supply: max 150V - 50/60 Hz
- Rated overload current: 10A - 10s
- Electronic protection: (in the event of overload, short-circuit, loss of voltage sensing) this acts to restore the value of the excitation current to 1A after 10 s. The alternator must be stopped (or the power switched off) in order to reset the protection.
- Fuse: F1 on X1, X2. 10A ; slow - 250V
- Voltage sensing : 5 VA isolated via transformer
 - 0-110 V terminals = 95 to 140 V
 - 0-220 V terminals = 170 to 260 V
 - 0-380 V terminals = 340 to 520 V

for other voltages, a transformer should be used.

- Voltage regulation $\pm 0.5\%$
- Normal or rapid response time via jumper **ST2** (see below)

- Voltage adjustment via potentiometer **P2** or apply a DC voltage of ± 1 V on the terminals of the external potentiometer

- Current sensing: (parallel operation): input S1, S2 intended for 1 C.T. \bar{S} 2.5 VA cl1, secondary 1A (optional)

- Quadrature droop adjustment via potentiometer **P1**

- Max. excitation current adjustment via **P5**: 4.5 to 10A (see below)

- 50/60 Hz selection via **ST3** jumper

- **ST11**: Knee-point at 65 Hz for Tractelec application and variable speed.

3.1.1 - Configuration jumpers function

Pot.	Delivery config.		Position	Function
	Open	Closed		
ST1	3-ph.	Mono		Open for module installation tri detection
ST2	Fast	Normal		Response time
ST3			50 ou 60 Hz	Frequency selection
ST4	External potentiometer	Without		Potentiometer
ST5	Without	With		LAM
ST6			closed	Alternator LSA 46.2 and LSA 472
	With		open	Alternator LSA 49.1
	no jumper			Alternator LSA 50.2
ST9	Others (PMG...)	AREP SHUNT		Supply
ST10			13% or 25%	LAM voltage drop amplitude
ST11	65 Hz	48 or 58 Hz		U/f function bend position

3.1.2 - Setting potentiometers function

Delivery position	Pot.	Function
0	P1	Quadrature droop ; // operation with C.T.
400V	P2	Voltage
Centre	P3	Stability
Maxi	P5	Excitation current ceiling

R448 & R448 V50

A.V.R.

3.2 - Frequency compared with voltage (without LAM)

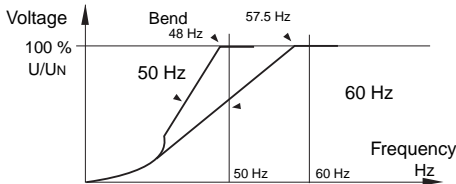

3.3 - LAM (Load Acceptance Module) characteristics

3.3.1 - Voltage drop

The LAM system is integrated in the regulator, as standard it is active (ST5 with bridge). It can be deactivated by removing the ST5 bridge. It can be adjusted to 13% or 25% by means of the ST10 jumper.

- Role of the "LAM" (Load Acceptance Module):

On application of a load, the rotation speed of the generator set decreases. When it passes below the preset frequency threshold, the LAM causes the voltage to drop by approximately 13% or 25% and consequently the amount of active load applied is reduced by approximately 25% to 45%, until the speed reaches its rated value again.

Hence the LAM can be used either to reduce the speed variation (frequency) and its duration for a given applied load, or to increase the applied load possible for one speed variation (turbo-charged engine).

To avoid voltage oscillations, the trip threshold for the LAM function should be set approximately 2 Hz below the lowest frequency in steady state.

It is advisable to use the LAM at 25% for load impacts $\leq 70\%$ of the genset rated power.

- LAM : action eliminated by cutting the ST5 jumper.

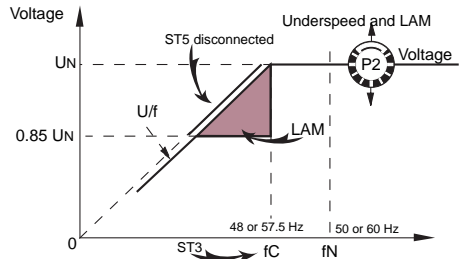

3.3.2 - Gradual voltage return function

During load impacts, the function helps the genset to return to its rated speed faster thanks to a gradual increase in voltage according to the principle:

- If the speed drops between 46 and 50 Hz, the rated voltage follows a fast gradient as it is restored.

- If the speed drops below 46 Hz, since the engine needs more help, the voltage follows a slow gradient as it returns to the reference value.

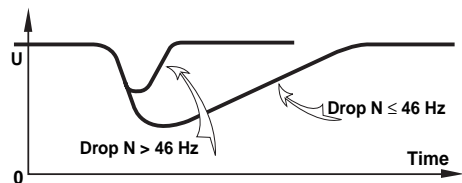

R448 & R448 V50

A.V.R.

3.4 - Typical effects of the LAM with a diesel engine with or without a LAM (U/F only)

3.4.1 - Voltage

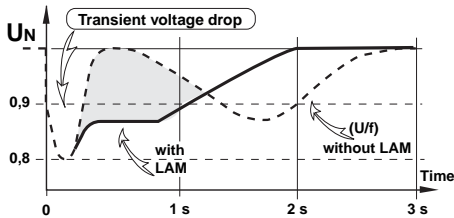

3.4.2 - Frequency

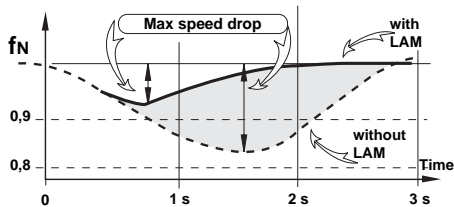

3.4.3 - Power

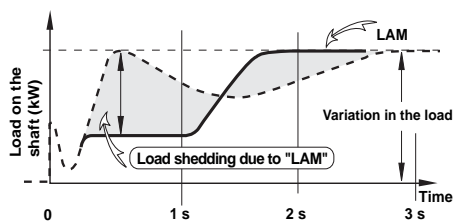

3.5 - R448 A.V.R. options

- **Current transformer** for parallel operation of...../ 1A Š 2.5 VA CL 1 (See the diagram in this manual).

- **Voltage transformer** (adaptation)

- Remote voltage adjustment potentiometer: 470 Ω , 0.5 W min : adjustment range $\pm 5\%$ (range limited by internal voltage potentiometer P2). Remove ST4 to connect the potentiometer. (A 1 k Ω potentiometer can also be used to extend the adjustment range).

- **R 731 module**: detection of 200 to 500V 3-phase voltage, compatible with parallel operation. Disconnect ST1 to connect the module; set the voltage via the potentiometer.

- **R 734 module**: detection of 3-phase current and voltage for parallel operation on unbalanced installations (imbalance > 15%)

- **R 726 module**: regulation system changed to "4-function". (See the maintenance manual and connection diagram.)

- PF regulation φ (2F)

- voltage matching before paralleling (3 F)

- mains connection of alternators already running in parallel (4F)

- **R 729 module**: same as R 726 with additional functions

- detection of a diode fault

- 4/20 mA input

- possibility of kVAR regulation

- **Control through DC voltage** used monitoring apply to the terminals for connection of a potentiometer DC voltage :

- internal impedance 1,5 k Ω

- $\pm 0,5V$ enable a voltage setting of 10%.

R448 & R448 V50

A.V.R.

4 - INSTALLATION - COMMISSIONING

4.1 - Electrical checks on the AVR

- Check that all connections have been made properly as shown in the attached wiring diagram.
- Check that the ST3 frequency selection jumper is on the correct frequency setting.
- Check whether the ST4 jumper or the remote adjustment potentiometer have been connected.
- Optional operating modes.
 - ST1 jumper : open to connect the R 731 or R 734 3-phase sensing module.
 - ST2 jumper : open if rapid response time used
 - ST5 jumper : open to suppress the LAM function.
 - ST9 jumper : closed with AREP, open with PMG.

4.2 - Settings



The machine is tested and set at the factory. When first used with no load, make sure that the drive speed is correct and stable (see the nameplate). After operational testing, replace all access panels or covers. The only possible adjustments to the machine should be made on the AVR.

4.2.1 - R448 settings (AREP or PMG system)

WARNING

Before any intervention on the A.V.R., make sure that the ST9 jumper is closed with AREP / SHUNT excitation and disconnected with PMG or separate excitation.

- a) Initial potentiometer settings (see table below)
- Remote voltage adjustment potentiometer : centre (ST4 jumper removed).

Action	Factory setting	Pot.
Voltage minimum fully anti-clockwise	400V - 50 Hz (Input 0 - 380 V)	
Stability	Not set (centre position)	
Voltage quadrature droop (// operation with C.T.) - 0 quadrature loop fully anti-clockwise.	Not set (fully anti-clockwise)	
Excitation ceiling Limit of excitation and short-circuit current, minimum fully anti-clockwise.	10 A maximum	

Stability adjustments in standalone operation

- b) Install a D.C. analogue voltmeter (needle dial) cal. 100V on terminals E+, E- and an A.C. voltmeter cal 300 - 500 or 1000V on the alternator output terminals.
- c) Make sure that the ST3 jumper is positioned on the desired frequency (50 or 60 Hz).
- d) Voltage potentiometer P2 at minimum, fully anti-clockwise.
- e) Stability potentiometer P3 to around 1/3 of the anti-clockwise limit.
- f) Start the engine and set its speed to a frequency of 48 Hz for 50 Hz, or 58 for 60 Hz.
- g) Set the output voltage to the desired value using P2.
 - Rated voltage UN for solo operation (eg. 400 V)
 - Or UN + 2 to 4% for parallel operation with C.T. (eg. 410 V)
 If the voltage oscillates, use P3 to make adjustments (try both directions) observing

R448 & R448 V50

A.V.R.

the voltage between E+ and E- (approx. 10V D.C.). The best response times are obtained at the limit of the instability. If no stable position can be obtained, try disconnecting or replacing the ST2 jumper (normal/fast).

h) Check LAM operation : ST5 closed.

i) Vary the frequency (speed) around 48 or 58 Hz according to the operating frequency, and check the change in voltage from that observed previously (~ 15%).

j) Readjust the speed of the unit to its rated no-load value.

Adjustments in parallel operation

Before any intervention on the alternator, make sure that the speed droop is identical for all engines.

k) Preset for parallel operation (with C.T. connected to S1, S2)

- Potentiometer P1 (quadrature droop) in centre position.

Apply the rated load ($\cos \varphi = 0.8$ inductive). The voltage should drop by 2 to 3%. If it increases, check that V and W and also S1 and S2 have not been reversed.

l) The no-load voltages should be identical for all the alternators intended to run in parallel.

- Couple the machines in parallel.

- By adjusting the speed, try to obtain 0 KW power exchange.

- By altering the voltage setting P2 on one of the machines, try to cancel (or minimise) the current circulating between the machines.

- **From now on, do not touch the voltage settings.**

m) Apply the available load (the setting is only correct if a reactive load is available)

- By altering the speed, match the KW (or divide the rated power of the units proportionally)

- By altering the quadrature droop potentiometer P1, match or divide the currents.

4.2.2 - Max. excitation setting (excitation ceiling)

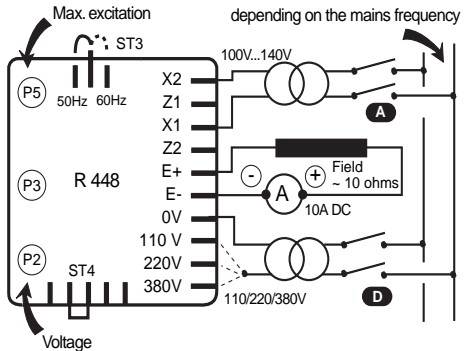

- static adjustment of the current limit , potentiometer P5 (fuse rating : 8 A - 10 seconds).

The maximum factory setting corresponds to that of the excitation current required to obtain a 3-phase short-circuit current of approximately 3 IN at 50 Hz for industrial power, unless otherwise specified(*).

A static method can be used to reduce this value or adapt the Isc to the actual operating power (derated machine), which is safer for the alternator and the installation.

- Disconnect power supply wires X1,X2 and Z1,Z2 and the voltage reference (0-110V-220V-380V) on the alternator.

Connect the mains power supply using a transformer (200-240V) as indicated (X1,X2) : 120V).

- Apply the corresponding voltage to the voltage reference input used

- Supply the AVR with a voltage of 120V max. on the X1, X2 input.

- Install a 10A D.C. ammeter in series with the exciter field.

- Turn P5 fully anti-clockwise and activate the power supply. If there is no output current from the AVR, turn potentiometer P2 (voltage) clockwise until the ammeter indicates a stable current.

- Switch the power supply off, then on again, turn P5 clockwise until the required max. current is obtained (no more than 10 A).

Checking the internal protection :

R448 & R448 V50

A.V.R.

Open switch (D) : the excitation current should increase to its preset ceiling, remain at that level for ≥ 1 second in AREP or 10 seconds in PMG and then drop to $< 1A$.

To reset, switch off the power supply by opening switch (A). Reconnect the AVR to the alternator and adjust the reference voltage via P2 to obtain the rated voltage.

(*): In some countries it is a legal requirement to have a short-circuit current, so as to offer discriminating protection.

4.2.3 - Special type of use

WARNING

Excitation circuit E+, E- must not be left open when the machine is running : AVR damage will occur.

4.2.3.1 - R448 field weakening (SHUNT)

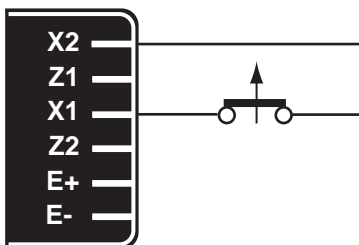

The exciter is switched off by disconnecting the AVR power supply (1 wire - X1 or X2). Contact rating 16 A - 250V A.C.

4.2.3.2 - R448 field weakening (AREP/ PMG)

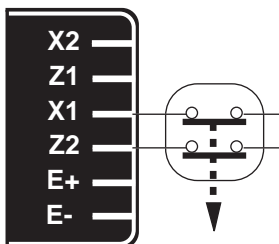

The exciter is switched off by disconnecting the AVR power supply (1 wire on each auxiliary winding) - contact rating 16 A - 250V A.C.

Connection is identical for resetting the AVR internal protection.



In case of using the de-excitation, provide a forced excitation.

4.2.3.3 - R448 field forcing

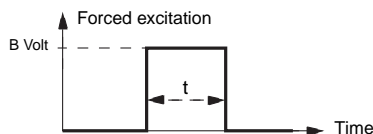
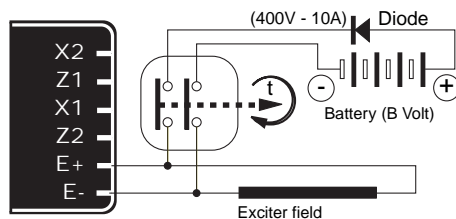

Applications	B volts	Time t
Guaranteed voltage build-up	12 (1A)	1 - 2 s
Parallel operation, de-energized	12 (1A)	1 - 2 s
Parallel operation, at standstill	24 (2A)	5 - 10 s
Frequency starting	48 (4A)	5 - 10 s
Sustained voltage on overload	48 (4A)	5 - 10 s

R448 & R448 V50

A.V.R.

4.3 - Electrical faults

Fault	Action	Effect	Check/Cause
No voltage at no load on start-up	Connect a new battery of 4 to 12 volts to terminals E- and E+, respecting the polarity, for 2 to 3 seconds	The alternator builds up and its voltage is still correct when the battery is removed.	- Lack of residual magnetism
		The alternator builds up but its voltage does not reach the rated value when the battery is removed.	- Check the connection of the voltage reference to the AVR - Faulty diodes - Armature short-circuit
		The alternator builds up but its voltage disappears when the battery is removed	- Faulty AVR - Field windings disconnected - Main field winding open circuit - check the resistance
Voltage too low	Check the drive speed	Correct speed	Check the AVR connections (AVR may be faulty) - Field windings short-circuited - Rotating diodes burnt out - Main field winding short-circuited - Check the resistance
		Speed too low	Increase the drive speed (Do not touch the AVR voltage pot. (P2) before running at the correct speed.)
Voltage too high	Adjust AVR voltage potentiometer	Adjustment ineffective	Faulty AVR
Voltage oscillations	Adjust AVR stability potentiometer	If no effect : try normal / fast recovery modes (ST2)	- Check the speed : possibility of cyclic irregularity - Loose connections - Faulty AVR - Speed too low when on load (or U/F bend set too high)
Voltage correct at no load and too low when on load (*)	Run at no load and check the voltage between E+ and E- on the AVR	Voltage between E+ and E- SHUNT < 20 V - AREP / PMG < 10V	- Check the speed (or U/F bend set too high)
		Voltage between E+ and E- SHUNT > 30V - AREP / PMG > 15V	- Faulty rotating diodes - Short-circuit in the main field. Check the resistance - Faulty exciter armature.
(*) Caution : For single-phase operation, check that the sensing wires coming from the AVR are correctly connected to the operating terminals			
Voltage disappears during operation (**)	Check the AVR, the surge suppressor, the rotating diodes, and replace any defective components	The voltage does not return to the rated value.	- Exciter winding open circuit - Faulty exciter armature - Faulty AVR - Main field open circuit or short-circuited
(***) Caution : Internal protection may be activated (overload, open circuit, short-circuit)			



Warning : after operational testing, replace all access panels or covers.

R448 & R448 V50

A.V.R.

5 - SPARE PARTS

5.1 - Designation

Description	Type	Code
A.V.R.	R 448	AEM 110 RE 016
A.V.R.	R 448 V50	AEM 110 RE 022

5.2 - Technical support service

Our technical support service will be happy to provide any information you require.

When ordering spare parts, you should indicate the complete machine type, its serial number and the information indicated on the nameplate.

Part numbers should be identified from the exploded views and their description in the parts list.

Our extensive network of "service stations" can dispatch the necessary parts without delay.

To ensure correct operation and the safety of our machines, we recommend the use of original manufacture spare parts.

In the event of failure to comply with this advice, the manufacturer cannot be held responsible for any damage.

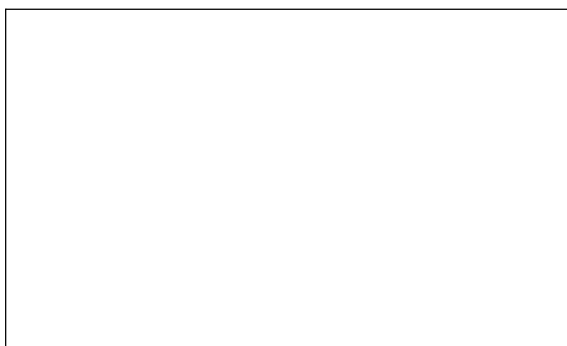

MOTEURS LEROY-SOMER 16015 ANGOULÊME CEDEX -

FRANCE

338 567 258 RCS ANGOULÊME
S.A. au capital de 62 779 000 euro