

**Available For  
Quick Delivery**



**Bronze and  
Stainless Steel  
2-Way**

# **SOLENOID VALVES**

For Control Of  
**WATER • OIL • STEAM  
AIR • GAS • CRYOGENICS  
SOLVENTS • OXYGEN  
CORROSIVE FLUIDS**





# WELCOME TO MAGNATROL

## Process Control Solenoid Valves For

Water • Oil • Air • Gas • Steam • Cryogenics • Vacuum • Solvents • Brine • Oxygen • Corrosive Fluids



### Magnatrol Valve Corp.

- Established 1936
- Experienced Dedicated Sales Staff
- Application / Engineering Assistance
- Excellent Product Support
- Quick Delivery

Our continued success has come from manufacturing a top quality product, product support, commitment to service and on-time delivery assuring complete customer satisfaction.

### Our Products

Every valve is manufactured and tested in-house following Quality Assurance Standards where production operations are under the control of our dedicated, experienced staff and workforce.

- High Quality Bronze and Stainless Steel Solenoid Valves\*
- Pressures up to 500 PSI \*
- Temperatures up to 400° F \*
- Cryogenic and Oxygen Service Applications
- Normally Closed (Energize to Open)
- Normally Open (Energize to Close)
- Continuous Duty Coils for all AC & DC Voltages
- NO Differential Pressure Required to Open
- Full Port-Internal Pilot Operated or Direct Acting
- 2-Way Straight Thru Design
- Packless Construction

\* **Custom Engineered Valves**, Special Alloys, Temperatures, Pressures and Applications as well as Modifications to Standard Magnatrol Valves are available through Magnatrol's **Clark-Cooper Division**. (See bottom of page 3)

TABLE OF CONTENTS	
Category	Pages(s)
Coils.....	4
Construction Features.....	5
<b>Bronze Valves</b>	
N & NR.....	6 & 7
A & AR.....	8 & 9
M & MR.....	10 & 11
S & SR.....	12 & 13
L & LR.....	14 & 15
G & GR.....	16 & 17
D.....	18
Strainers.....	19
<b>Stainless Steel Valves</b>	
K & KR.....	20 & 21
W & WR.....	22 & 23
Optional Features.....	24 & 25
Ordering Information.....	26 & 27
Terms & Conditions/Contact Info.....	28

ADDITIONAL CATALOGS	
<b>Technical/Engineering Catalog .. 3006-ENG</b>	Technical & Engineering Data including:
	• Sandy Well Water Valves
	• Gritty Coolant Valves
<b>Universal Mount Catalog .. 3006-UM</b>	Valves can be mounted in any position

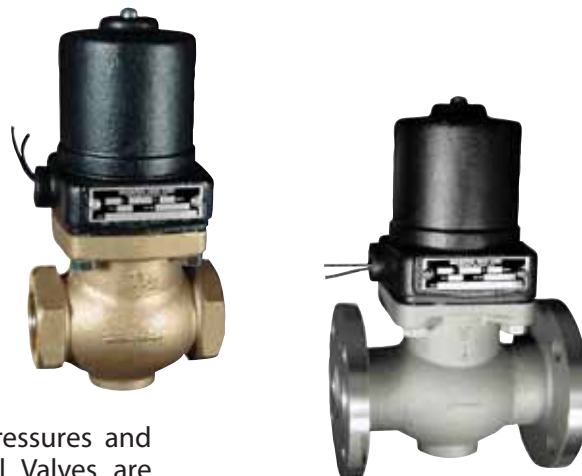

## MAGNATROL VALVE CORPORATION

Magnatrol Valve Corporation • P.O. Box 17 • 67 Fifth Avenue • Hawthorne • New Jersey • 07507  
 info@magnatrol.com • Phone: 973-427-4341 • Fax: 973-427-7611 • www.magnatrol.com





# VALVE SELECTION CHART

**Ordering Information - See Pages 26 & 27  
For Optional Features - See Pages 24 & 25**

## VALVE SELECTION CHART

**(For Fluids/Gases Not Listed And For Special Applications, Consult Factory)**

Max . Temperature	Up To 212°F				Up To 400°F				
Construction	Bronze							Stainless Steel	
Valve Type	D	G	N	A	M	S	L	K	W
Page	18	16 & 17	6 & 7	8 & 9	10 & 11	12 & 13	14 & 15	20 & 21	22 & 23
Max. Diff. Pressure	30 PSI	50 PSI	300 PSI	500 PSI	150 PSI	180 PSI	500 PSI	500 PSI	180 PSI
Pipe Size Inches	3/8"-2"	1"-3"	1/4"-3/4"	1/2"-3"	3/8"-3/4"	1/2"-3"	1/2"-3"	1/2"-2"	1/2"-2"
Internal Port Size	Full	Full	Reduced	Full	Reduced	Full	Full	Full	Full
Air	◆	◆	◆	◆	◆		◆	◆	
Brine			◆	◆	◆		◆	◆	
Gas	◆	◆		◆	◆		◆	◆	
Oil	◆		◆	◆	◆		◆	◆	
Solvents	◆	◆	◆	◆	◆		◆	◆	
Water	◆	◆	◆	◆	◆		◆	◆	
Vacuum	◆	◆	◆	◆					
Steam					◆	◆			◆
Cryogenic					◆		◆	◆	
Oxygen, Liquid					◆		◆	◆	
Oxygen, Gaseous	◆	◆		◆			◆	◆	
Corrosive								◆	

**Use the chart above to determine suitable types of Magnatrol valves for a given application.**

Example: A normally closed 1/2" valve for use on 100 psi steam, there are three types suitable and the final selection can only be made after referring to Bulletins 3006-M, 3006-S and 3006-W on pages 10, 12 and 22 respectively.

**Maximum Differential Pressure:**

When specifying a valve, the Maximum Differential Pressure must be equal to or greater than the application. Care should be taken not to "over specify" the valve by choosing a valve with a Maximum Differential Pressure that is excessively beyond the application.

**If you are unsure please consult the factory.**

**For Custom Engineered Valves,  
modifications to standard Magnatrol valves and valves that fall outside standard valve capabilities,  
contact Magnatrol's Clark Cooper Division**

**2-Way and 3-Way • 1/4" Thru 6"**

- Pressures to 10,000
- Fluid Temperatures up to 550°F
- Dirty /Viscous & Corrosive Fluids
- Bronze, 316SS, Monel, Alloy 20 & Hastelloy
- End connections: NPT, Flange, Union, Socket Weld, Butt Weld, Pipe Nipples etc.
- Options: Remote Trip with Manual or Automatic Reset and many others
- Designs for Navy and Marine Service

3-Valve  
Manifold for  
CNG Refueling



High Pressure  
Cartridge Valve  
10,000 PSI



3-Way Trip Valve With 2 Position  
Indicating Switches  
and Manual Reset



**CLARK - COOPER DIV.**  
855 INDUSTRIAL HIGHWAY - #4  
CINNAMINSON, NJ 08077

Phone: 856 - 829 - 4580 • Fax: 856 - 829 - 7303  
Email: techsupport@clarkcooper.com  
Web: www.clarkcooper.com

**MAGNATROL VALVE CORPORATION**



**SOLENOID COILS  
CONTINUOUS DUTY COILS**

**ELECTRICAL CHARACTERISTICS**

**Coils are stocked for the following voltages:**

Voltage	6	12	24	32	48	64	120	208	240	480	575
50, 60 Hertz AC			•				•	•	•	•	•
DC	•	•	•	•	•	•	*		*		

\* Furnished with surge protecting capacitor

Reference should be made to the Bulletins to determine the availability of a required valve for a specific power supply.

Consult the factory for information regarding voltage and frequencies not listed.

Valves for A.C. service can be converted for use on other A.C. voltages simply by changing the coil. Similarly D.C. valves can be converted for other D.C. voltages. Consult factory regarding conversion from A.C. to D.C. or D.C. to A.C.



**ENCAPSULATED COIL**

**CURRENT CONSUMPTION:**

Current values shown in the bulletins are for 120 volts, 60 hertz. For other voltages the current is inversely proportional: For instance, if a given valve draws 0.5 amperes on 120 volts it would draw 0.25 amperes on 240 volts, or 0.125 amperes on 480 volts. Where power consumption is shown in D.C. watts, the values given should be divided by line voltage to obtain the current in amperes. Power consumption for all valves is shown in the individual bulletins.

**CONSTRUCTION:**

**Coils can be continuously energized without overheating or failure.** Coils supplied with 18" long, 18 gage wire leads standard\*\*, encapsulated for temperature of intended service, providing a coil with excellent resistance to shock, moisture, oil and chemicals.

**General Service:** Class "B" coils supplied for gas and liquids up to 212° F and where ambient temperatures do not exceed 40° C (104° F). The Class "H" coil should be specified for higher ambient temperatures.

**High Temperature Service:** Class "H" coils supplied for gases and liquids from 212° - 400° F and where ambient temperatures do not exceed 100° C (212° F).

\*\*Longer continuous leads available

**INSTALLATION:**

The coil is a two wire device which may be controlled by either a single or double pole switch. The switch should always be installed in the hot leg of 120 volt circuits. Where both legs are hot, such as 240 or 480 volt circuits, a double pole switch is preferable, however, if a single pole switch is used, then the wiring should have top quality insulation since even minute leakage currents may give rise to sticking problems. On motor hookup with step control starter, full voltage should be supplied to coil immediately.

**Note:** Coil can be readily changed while valve is still under pressure.

# VALVE CONSTRUCTION FEATURES



## Valve Construction Features:

- 2-way straight thru globe design
- Bronze or Stainless Steel body w/ female NPT threads standard
- Stainless Steel available with 150# and 300# flanged ends
- Full port-internal pilot operated or direct acting
- Packless construction
- Continuous duty coils for all voltages
- No differential pressure required to open.

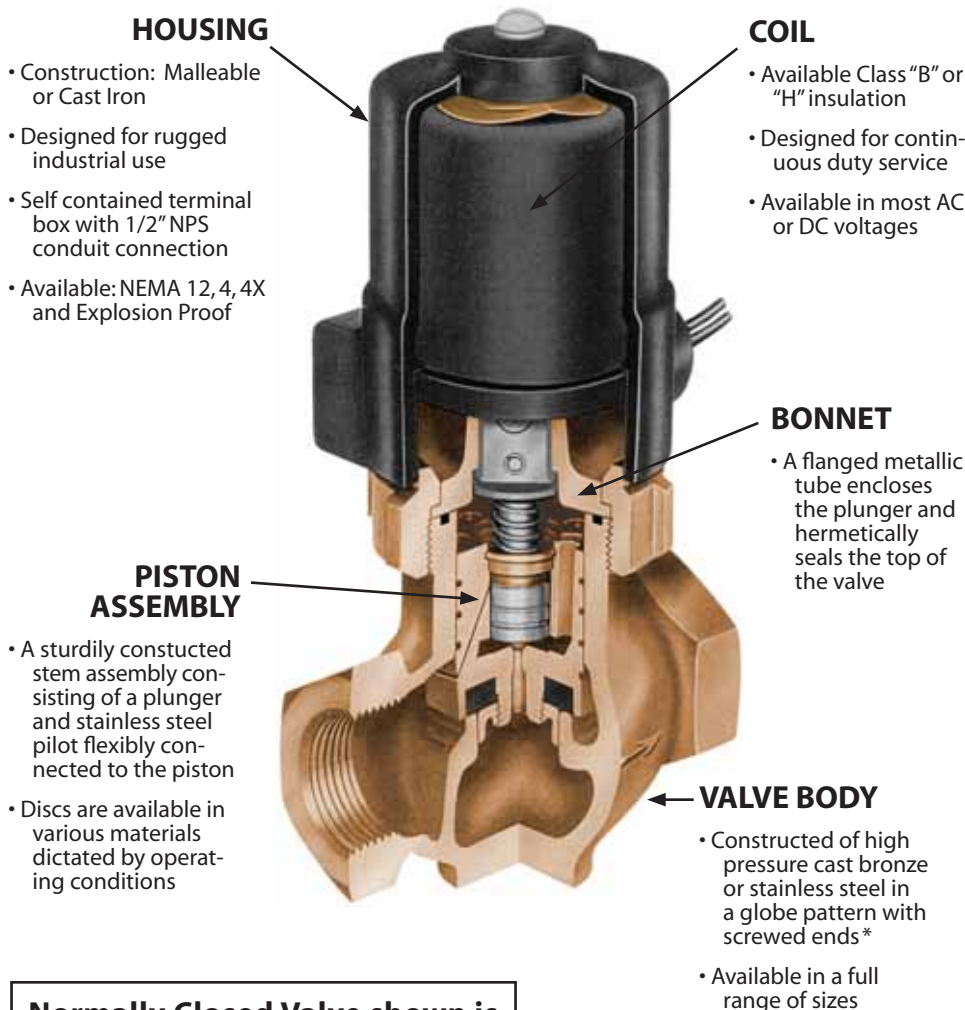

**Normally Closed Valve shown is typical of Type A, 1/2" thru 1-1/4"**

\* Stainless Steel valves available with flanged ends. Flanged Bronze valves available through Magnatrol's **Clark-Cooper Division** (See bottom of page 3).

## Easy In-Line Service

Inspect, clean or service all internal parts of full port-internal pilot operated or direct acting solenoid valves while the valve body remains in the pipeline shortening costly down time and increasing productivity.

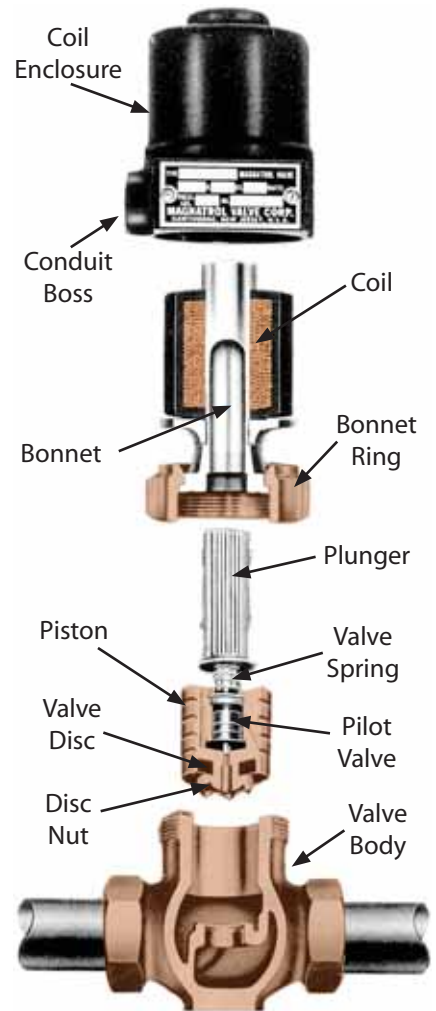

**MAGNATROL SOLENOID OPERATED VALVES** are used to control the flow of liquids or gases, generally in conjunction with automatic control apparatus such as thermostat, float switch, time switch, or flow meter.



# BRONZE SOLENOID VALVES

Dependable • Packless

## TYPE "N" - NORMALLY CLOSED 1/4" TO 3/4" PIPE SIZE

*NO DIFFERENTIAL PRESSURE REQUIRED TO OPEN*

### DIRECT ACTING - ORIFICE SIZES 3/32" TO 1/2"

**OPERATION:**

Valve opens when energized and closes when de-energized. In this direct acting valve, when the coil is energized, the stem is lifted from its conical seat by the plunger.

**CONSTRUCTION:** (\* Wetted parts)

- \*Valve Body - Cast Bronze, Globe Pattern - NPT ends
- Coil Enclosure - Malleable Iron, 1/2" NPS conduit conn.
- \*Plunger - 430 Stainless Steel
- \*Valve Stem - 303 Stainless Steel
- \*Bonnet Tube - 304 Stainless Steel
- \*Spring - 302 Stainless Steel
- \*Body Seal - Buna N
- \*Orifice Seal - Metal to Metal
- \*AC Shading Coil - Copper
- \*Stem Pin - Inconel
- Coil - Encapsulated Class B, 18" leads - (Class H available)

**APPLICATION:**

To control the flow of **Water, Oil, Air, Gas, Solvents, Brine, Vacuum** and any other fluids not reactive with construction materials and free of sediment. Valve operates from zero to maximum differential pressure indicated in table. Valve must be mounted in horizontal pipe with solenoid enclosure vertical and on top.

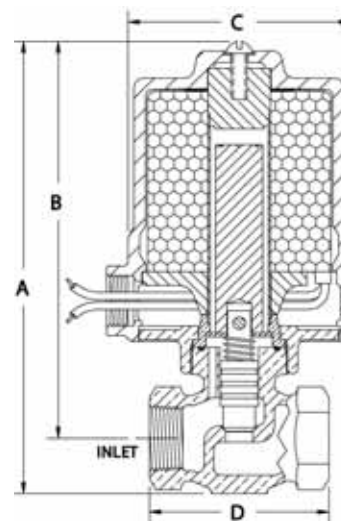

MAX. FLUID TEMP.  
**212° F**  
MAX. STATIC PRESSURE  
**300 PSI**



**FOR OPTIONS & ACCESSORIES  
SEE PAGES 24 & 25**

Pipe Size Inches	Max. Diff. PSI	Valve Port Size	Type No.	Watts AC	Amps Hold 120-60	Amps Inrush 120-60	Watts DC	Ship Wt. Lbs.	Dimensions In Inches			
									A	B	C	D
1/4	50	1/4	18N40	25	0.4	1.0	18	6	5-7/8	5-1/4	2-3/4	2-1/4
	75	3/16	18N50									
	100	5/32	18N80									
	150	1/8	18N60									
	225	3/32	18N70									
	100	1/4	33N40									
150	3/16	33N50										
300	1/8	33N60										
3/8	25	3/8	18N21	25	0.4	1.1	18	6	6-1/8	5-3/8	2-3/4	2-1/2
	50	1/4	18N41									
	75	3/16	18N51									
	100	5/32	18N81									
	150	1/8	18N61									
	225	3/32	18N71									
	50	3/8	33N21	45	0.8	2.3	23	10	7	6-1/4	3-1/2	2-1/2
	75	5/16	33N31									
	100	1/4	33N41									
150	3/16	33N51										
300	1/8	33N61										
1/2	25	3/8	18N22	25	0.4	1.2	18	6	6-1/4	5-3/8	2-3/4	2-3/4
	50	1/4	18N42									
	75	3/16	18N52									
	100	5/32	18N82									
	150	1/8	18N62									
	225	3/32	18N72									
	50	3/8	33N22	45	0.8	2.4	23	10	7-1/8	6-3/8	3-1/2	2-3/4
	75	5/16	33N32									
	100	1/4	33N42									
150	3/16	33N52										
300	1/8	33N62										
3/4	15	1/2	18N13	25	0.4	1.3	18	7	6-1/2	5-5/8	2-3/4	2-7/8
	35	5/16	18N33									
	30	1/2	33N13	45	0.8	2.5	23	7-3/8	6-1/2	3-1/2	2-7/8	
	75	5/16	33N33									

Strainers are recommended for use with solenoid valves (See page 19)

**When you order please supply the following:**

- Pipe Size
  - Valve Type
  - Voltage (AC or DC)
  - Hertz
  - Fluid
  - Fluid Temperature
  - Max. Diff. Pressure
  - Optional Features
- (See pages 24 & 25)



# BRONZE SOLENOID VALVES

Dependable • Packless



## TYPE "NR" - NORMALLY OPEN

1/4" TO 3/4" PIPE SIZE

*NO DIFFERENTIAL PRESSURE REQUIRED TO OPEN*

**DIRECT ACTING - ORIFICE SIZES 3/32" TO 1/2"**

**OPERATION:**

Valve closes when energized and opens when de-energized. In this direct acting valve, when the coil is energized, the stem is pressed into its conical seat by the plunger.

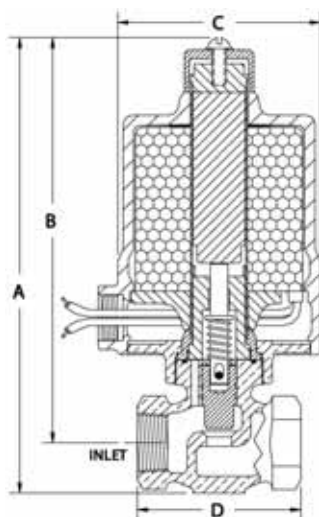

**CONSTRUCTION:** (\* Wetted parts)

- \*Valve Body - Cast Bronze, Globe Pattern - NPT ends
- Coil Enclosure - Malleable Iron, 1/2" NPS conduit conn.
- \*Plunger - 430 Stainless Steel
- \*Poppet - 304 Stainless Steel
- \*Stem - 303 Stainless Steel
- \*Bonnet Tube - 304 Stainless Steel
- \*Spring - Inconel
- \*Body Seal - Buna N
- \*Orifice Seal - Metal to Metal
- \*AC Shading Coil - Copper
- \*Stem Pin - 304 Stainless Steel
- Coil - Encapsulated Class B, 18" leads - (Class H available)

**APPLICATION:**

To control the flow of **Water, Oil, Air, Gas, Solvents, Brine, Vacuum** and any other fluids not reactive with construction materials and free of sediment. Valve operates from zero to maximum differential pressure indicated in table. Valve must be mounted in horizontal pipe with solenoid enclosure vertical and on top.



MAX. FLUID TEMP.

**212° F**

MAX. STATIC PRESSURE

**300 PSI**

**FOR OPTIONS & ACCESSORIES  
SEE PAGES 24 & 25**

Strainers are recommended for use with solenoid valves (See page 19)

**When you order please supply the following:**

- Pipe Size
  - Valve Type
  - Voltage (AC or DC)
  - Hertz
  - Fluid
  - Fluid Temperature
  - Max. Diff. Pressure
  - Optional Features
- (See pages 24 & 25)

Pipe Size Inches	Max. Diff. PSI	Valve Port Size	Type No.	Watts AC	Amps Hold 120-60	Amps Inrush 120-60	Watts DC	Ship Wt. Lbs.	Dimensions In Inches			
									A	B	C	D
1/4	45	1/4	18NR40	25	0.5	1.3	18	7	6-5/8	6	2-3/4	2-1/4
	70	3/16	18NR50									
	90	5/32	18NR80									
	135	1/8	18NR60									
	200	3/32	18NR70									
	90	1/4	33NR40									
135	3/16	33NR50										
270	1/8	33NR60										
270	1/8	33NR60										
3/8	23	3/8	18NR21	25	0.5	1.4	18	7	6-7/8	6-1/8	2-3/4	2-1/2
	45	1/4	18NR41									
	70	3/16	18NR51									
	90	5/32	18NR81									
	135	1/8	18NR61									
	200	3/32	18NR71									
45	3/8	33NR21	45	1.0	2.6	23	10	7-3/4	7	3-1/2	2-1/2	
70	5/16	33NR31										
90	1/4	33NR41										
135	3/16	33NR51										
270	1/8	33NR61										
270	1/8	33NR61										
1/2	23	3/8	18NR22	25	0.5	1.5	18	7	7	6-1/8	2-3/4	2-3/4
	45	1/4	18NR42									
	70	3/16	18NR52									
	90	5/32	18NR82									
	135	1/8	18NR62									
	200	3/32	18NR72									
45	3/8	33NR22	45	1.0	2.7	23	10	7-7/8	7-1/8	3-1/2	2-3/4	
70	5/16	33NR32										
90	1/4	33NR42										
135	3/16	33NR52										
270	1/8	33NR62										
270	1/8	33NR62										
3/4	13	1/2	18NR13	25	0.5	1.6	18	7	7-1/4	6-3/8	2-3/4	2-7/8
	32	5/16	18NR33									
	27	1/2	33NR13	45	1.0	2.8	23	10	8-1/8	7-1/4	3-1/2	2-7/8
	70	5/16	33NR33									



# BRONZE SOLENOID VALVES

Dependable • Packless

## TYPE "A" FULL PORT - NORMALLY CLOSED 1/2" TO 3" PIPE SIZE

*NO DIFFERENTIAL PRESSURE REQUIRED TO OPEN*

**MAX. FLUID TEMP.**  
**212° F**

**MAX. STATIC PRESSURE**  
**300 PSI**

Except valves listed for 500 PSI

**OPERATION:**

Valve opens when energized and closes when de-energized. When the coil is energized the pilot valve opens, relieving the pressure above the piston, which is then lifted from its seat by the plunger. Upon de-energizing the coil, a spring closes the pilot valve and opens a bleed passageway to permit pressure to build above the piston and seat it.

**CONSTRUCTION:** (\* Wetted parts)

- \*Valve Body - Cast Bronze, Globe Pattern - NPT ends
- \*Piston - Bronze
- Coil Enclosure - Malleable or Cast Iron, 1/2" NPS conduit conn.
- \*Plunger - 430 Stainless Steel
- \*Pilot Valve - 303 Stainless Steel
- \*Bonnet Tube - 304 Stainless Steel
- \*Spring - 302 Stainless Steel
- \*Body Seal - Buna N or Non Asbestos Gasket
- \*Orifice Seal - Buna N (Viton or Glass Filled Teflon available)
- \*AC Shading Coil - Copper
- \*Stem Pin - Inconel
- Coil - Encapsulated Class B, 18" leads - (Class H available)

**APPLICATION:**

To control the flow of Water, Oil, Air, Gas, Solvents, Brine, Vacuum and any other fluids not reactive with construction materials and free of sediment. Valve operates from zero to maximum differential pressure indicated in table. Valve must be mounted in horizontal pipe with solenoid enclosure vertical and on top.

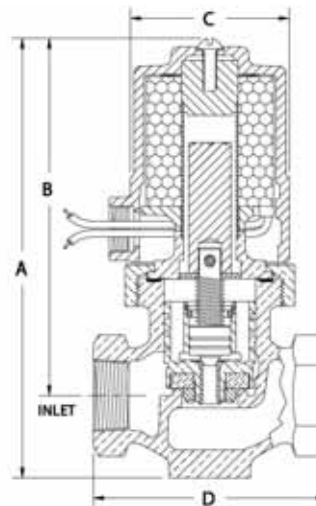

Pipe Size Inches	Max. Diff. PSI	Type No.	Watts AC	Amps Hold 120-60	Amps Inrush 120-60	Watts DC	Ship Wt. Lbs.	Dimensions In Inches			
								A	B	C	D
1/2	110	18A42	25	0.4	1.2	18	8	7	5-7/8	2-3/4	3-1/4
	200	18A32									
	300	18A52									
3/4	500	E33A62	45	0.8	2.4	23	16	8	6-7/8	4-1/8	3-1/4
	50	18A23	25	0.4	1.3	18	8	7-1/8	6	2-3/4	3-1/2
	110	18A43									
	160	118A43	40	0.6	2.0	28	12	8-1/8	7	3-1/2	3-1/2
	200	33A33	45	0.8	2.6	23	17	8-1/8	7	4-1/8	3-1/2
	300	33A53									
500	E133A63	65	1.2	3.9	33	19	8-7/8	7-1/2	4-1/8	4-1/8	
1	50	18A24	25	0.4	1.5	18	10	7-7/8	6-5/8	2-3/4	4-1/8
	110	18A44									
	160	118A44	40	0.6	2.3	28	14	8-7/8	7-1/2	3-1/2	4-1/8
	200	33A34	45	0.8	2.8	23	19	8-7/8	7-1/2	4-1/8	4-1/8
	300	33A54									
500	E133A64	65	1.2	4.2	33	20	10-3/8	8-3/4	4-1/2	4-1/2	
1-1/4	50	18A25	25	0.4	1.6	18	12	8-3/8	6-3/4	2-3/4	4-1/2
	90	18A45									
	150	118A45	40	0.6	2.4	28	16	9-3/8	7-3/4	3-1/2	4-1/2
	200	33A35	45	0.8	3.0	23	20	10-3/8	8-3/4	4-1/2	4-1/2
	300	33A55									
500	†† 40A65	60	1.2	6.2	N/A	20	10-3/8	8-3/4	4-1/2	4-1/2	
1-1/2	50	35A26	45	0.8	3.2	23	20	10	8-1/8	4	4-7/8
	115	35A46									
	160	135A46	65	1.2	4.8	33	24	11	9-1/8	4-1/2	4-7/8
	200	41A36	60	1.2	6.7	35	36	12	9-3/4	5-3/8	6
	300	41A56									
500	141A66	85	2.0	10.0	45	43	12-7/8	10-1/8	5-7/8	7-1/4	
2	50	36A27	45	0.8	3.5	23	31	11	8-3/4	5-3/8	6
	100	36A47									
	150	136A47	65	1.2	5.0	33	36	12	9-3/4	5-3/8	6
	200	42A37	60	1.2	7.4	35	45	12	9-3/4	5-3/8	6
	300	42A57									
500	142A67	85	2.0	11.0	45	56	13-3/4	10-1/2	6-5/8	8-3/8	
2-1/2	50	43A28	60	1.2	8.0	35	43	12-7/8	10-1/8	5-7/8	7-1/4
	125	43A48									
	200	43A38									
	300	143A58									
3	50	44A29	60	1.2	8.8	35	56	13-3/4	10-1/2	6-5/8	8-3/8
	100	44A49									
	200	44A39									
	300	144A59									

**FOR OPTIONS & ACCESSORIES  
SEE PAGES 24 & 25**

Strainers are recommended for use with solenoid valves (See page 19)

**When you order please supply the following:**

- Pipe Size
  - Valve Type
  - Voltage (AC or DC)
  - Hertz
  - Fluid
  - Fluid Temperature
  - Max. Diff. Pressure
  - Optional Features
- (See pages 24 & 25)

†† Not available for DC operation



# BRONZE SOLENOID VALVES

Dependable • Packless



## TYPE "AR" FULL PORT - NORMALLY OPEN 1/2" TO 3" PIPE SIZE

**NO DIFFERENTIAL PRESSURE REQUIRED TO OPEN**

**OPERATION:**

Valve closes when energized and opens when de-energized. When the coil is energized the plunger presses the poppet, closing the pilot orifice, and opens a bleed passageway to permit pressure to build above the piston and seat it. Upon de-energizing the coil, the pilot orifice is opened, relieving the pressure above the piston allowing it to leave its seat. The bottom spring allows the valve to operate at zero pressure drop.

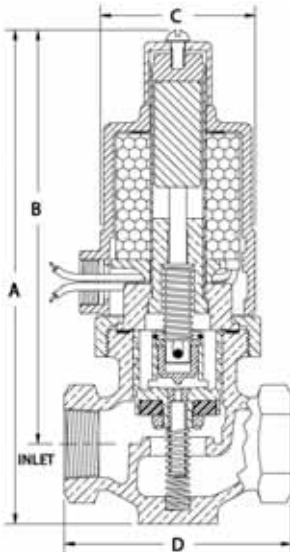

**CONSTRUCTION:** (\* Wetted parts)

- \*Valve Body - Cast Bronze, Globe Pattern - NPT ends
- \*Piston - Bronze
- Coil Enclosure - Malleable or Cast Iron, 1/2" NPS conduit conn.
- \*Plunger - 430 Stainless Steel
- \*Poppet - 303 Stainless Steel
- \*Stem - 303 Stainless Steel
- \*Bonnet Tube - 304 Stainless Steel
- \*Spring - Inconel and 302 Stainless Steel
- \*Body Seal - Buna N or Non Asbestos Gasket
- \*Orifice Seal - Buna N (Viton or Glass Filled Teflon available)
- \*AC Shading Coil - Copper
- \*Stem Pin - 304 Stainless Steel
- Coil - Encapsulated Class B, 18" leads - (Class H available)

**APPLICATION:**

To control the flow of Water, Oil, Air, Gas, Solvents, Brine, Vacuum and any other fluids not reactive with construction materials and free of sediment. Valve operates from zero to maximum differential pressure indicated in table. Valve must be mounted in horizontal pipe with solenoid enclosure vertical and on top.



**MAX. FLUID TEMP.**  
**212° F**  
**MAX. STATIC PRESSURE**  
**300 PSI**  
Except valves listed for 500 PSI

**FOR OPTIONS & ACCESSORIES  
SEE PAGES 24 & 25**

Strainers are recommended for use with solenoid valves (See page 19)

**When you order please supply the following:**

- Pipe Size
- Valve Type
- Voltage (AC or DC)
- Hertz
- Fluid
- Fluid Temperature
- Max. Diff. Pressure
- Optional Features

(See pages 24 & 25)

†† Not available for DC operation

Pipe Size Inches	Max. Diff. PSI	Type No.	Watts AC	Amps Hold 120-60	Amps Inrush 120-60	Watts DC	Ship Wt. Lbs.	Dimensions In Inches			
								A	B	C	D
1/2	110	18AR42	25	0.5	1.5	18	8	8-1/8	7	2-3/4	3-1/4
	200	18AR32									
	300	18AR52									
	500	E33AR62									
3/4	50	18AR23	45	1.0	2.9	23	13	9-1/4	8-1/8	3-1/2	3-1/2
	110	18AR43									
	200	33AR33									
	300	33AR53									
	500	E133AR63									
1	50	18AR24	65	1.5	4.5	33	19	10-1/4	8-7/8	4-1/8	4-1/8
	110	18AR44									
	200	33AR34									
	300	33AR54									
	500	E133AR64									
1-1/4	50	18AR25	60	1.7	6.2	N/A	21	11	9-3/8	4-1/2	4-1/2
	90	18AR45									
	200	33AR35									
	300	33AR55									
1-1/2	50	35AR26	85	3.5	9.7	45	25	11-3/8	9-1/2	4	4-7/8
	115	35AR46									
	200	41AR36									
	300	41AR56									
	500	141AR66									
2	50	36AR27	60	1.7	7.3	35	36	12-5/8	10-3/8	5-3/8	6
	100	36AR47									
	200	42AR37									
	300	42AR57									
	500	142AR67									
2-1/2	50	43AR28	85	3.5	13.0	45	45	13-1/2	10-3/4	5-7/8	7-1/4
	125	43AR48									
	200	43AR38									
	300	143AR58									
3	50	44AR29	85	3.5	13.0	45	57	14-3/8	11-1/8	6-5/8	8-3/8
	100	44AR49									
	200	44AR39									
	300	144AR59									



# BRONZE SOLENOID VALVES

Dependable • Packless

## TYPE "M" - NORMALLY CLOSED 3/8" TO 3/4" PIPE SIZE

*NO DIFFERENTIAL PRESSURE REQUIRED TO OPEN*

### DIRECT ACTING - ORIFICE SIZES 1/8" TO 1/2"

**OPERATION:**

Valve opens when energized and closes when de-energized. In this direct acting valve, when the coil is energized, the stem is lifted from its conical seat by the plunger.

**CONSTRUCTION:** (\* Wetted parts)

- \*Valve Body - Cast Bronze, Globe Pattern - NPT ends
- Coil Enclosure - Malleable Iron, 1/2" NPS conduit conn.
- \*Plunger - 430 Stainless Steel
- \*Valve Stem - 303 Stainless Steel
- \*Bonnet Tube - 304 Stainless Steel
- \*Spring - Inconel
- \*Body Seal - Non Asbestos Gasket
- \*Orifice Seal - Metal to Metal
- \*AC Shading Coil - Copper
- \*Stem Pin - Inconel
- Coil - Encapsulated Class H, 18" leads

**APPLICATION:**

To control the flow of **Steam, Hot Liquids, Hot Gases, Cryogenics\*\*** and any other fluids not reactive with construction materials and free of sediment. Cryogenic fluids include Liquid Oxygen (-297°F), Liquid Argon (-303°F) and Liquid Nitrogen (-320°F). Valve operates from zero to maximum differential pressure indicated in table. Valve must be mounted in horizontal pipe with solenoid enclosure vertical and on top.

**\*\*Cleaning:**

- Cryogenic valves are degreased and cleaned to keep them free of moisture.
- Oxygen valves are also "black light" tested.

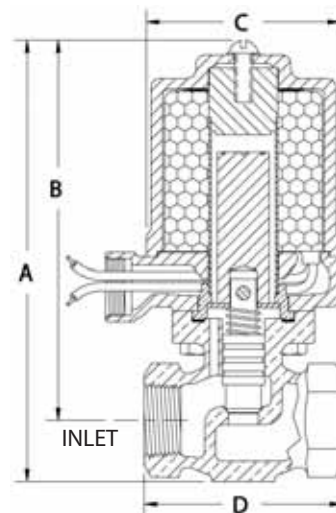

MAX. FLUID TEMP.  
**400° F**  
MAX. STATIC PRESSURE  
**150 PSI**



FOR OPTIONS & ACCESSORIES  
SEE PAGES 24 & 25

Pipe Size Inches	Max. Diff. PSI	Valve Port Size	Type No.	Watts AC	Amps Hold 120-60	Amps Inrush 120-60	Watts DC	Ship Wt. Lbs.	Dimensions In Inches												
									A	B	C	D									
3/8	25	3/8	10M21	25	0.4	1.1	18	6	6-1/4	5-1/2	2-7/8	2-5/8									
	50	1/4	10M41																		
	75	3/16	10M51																		
	100	5/32	10M81																		
	150	1/8	10M61																		
	50	3/8	25M21										45	0.8	2.3	23	10	7-1/8	6-3/8	3-1/2	2-5/8
75	5/16	25M31																			
100	1/4	25M41																			
150	3/16	25M51																			
25	3/8	10M22	25	0.4	1.2	18	6	6-1/4	5-1/2	2-7/8	2-3/4										
50	1/4	10M42																			
75	3/16	10M52																			
100	5/32	10M82																			
150	1/8	10M62																			
50	3/8	25M22										45	0.8	2.4	23	10	7-1/8	6-3/8	3-1/2	2-3/4	
75	5/16	25M32																			
100	1/4	25M42																			
150	3/16	25M52																			
3/4	15	1/2	10M13	25	0.4	1.3	18	7	6-1/2	5-5/8	2-7/8										2-7/8
	35	5/16	10M33																		
	30	1/2	25M13																		
	75	5/16	25M33																		

Strainers are recommended for use with solenoid valves (See page 19)

**When you order please supply the following:**

- Pipe Size
  - Valve Type
  - Voltage (AC or DC)
  - Hertz
  - Fluid
  - Fluid Temperature
  - Max. Diff. Pressure
  - Optional Features
- (See pages 24 & 25)

# BRONZE SOLENOID VALVES

Dependable • Packless



## TYPE "MR" - NORMALLY OPEN

### 3/8" TO 3/4" PIPE SIZE

*NO DIFFERENTIAL PRESSURE REQUIRED TO OPEN*

### DIRECT ACTING - ORIFICE SIZES 1/8" TO 1/2"

#### OPERATION:

Valve closes when energized and opens when de-energized. In this direct acting valve, when the coil is energized, the stem is pressed into its conical seat by the plunger.

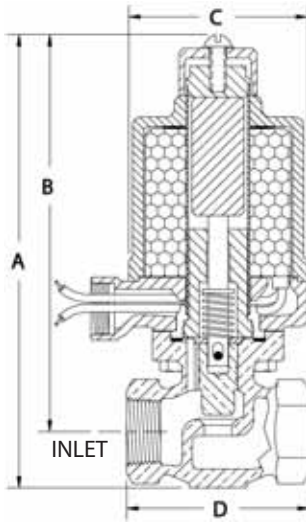

#### CONSTRUCTION: (\* Wetted parts)

- \*Valve Body - Cast Bronze, Globe Pattern - NPT ends
- Coil Enclosure - Malleable Iron, 1/2" NPS conduit conn.
- \*Plunger - 430 Stainless Steel
- \*Poppet - 304 Stainless Steel
- \*Stem - 303 Stainless Steel
- \*Bonnet Tube - 304 Stainless Steel
- \*Spring - Inconel
- \*Body Seal - Non Asbestos Gasket
- \*Orifice Seal - Metal to Metal
- \*AC Shading Coil - Copper
- \*Stem Pin - 304 Stainless Steel
- Coil - Encapsulated Class H, 18" leads



#### APPLICATION:

To control the flow of Steam, Hot Liquids, Hot Gases, Cryogenics\*\* and any other fluids not reactive with construction materials and free of sediment. Cryogenic fluids include Liquid Oxygen (-297°F), Liquid Argon (-303°F) and Liquid Nitrogen (-320°F). Valve operates from zero to maximum differential pressure indicated in table. Valve must be mounted in horizontal pipe with solenoid enclosure vertical and on top.

#### \*\*Cleaning:

- Cryogenic valves are degreased and cleaned to keep them free of moisture.
- Oxygen valves are also "black light" tested.

MAX. FLUID TEMP.

**400° F**

MAX. STATIC PRESSURE

**150 PSI**



**FOR OPTIONS & ACCESSORIES  
SEE PAGES 24 & 25**

Strainers are recommended for use with solenoid valves

(See page 19)

#### When you order please supply the following:

- Pipe Size
- Valve Type
- Voltage (AC or DC)
- Hertz
- Fluid
- Fluid Temperature
- Max. Diff. Pressure
- Optional Features

(See pages 24 & 25)

Pipe Size Inches	Max. Diff. PSI	Valve Port Size	Type No.	Watts AC	Amps Hold 120-60	Amps Inrush 120-60	Watts DC	Ship Wt. Lbs.	Dimensions In Inches			
									A	B	C	D
3/8	23	3/8	† 10MR21	25	0.5	1.4	18	7	7	6-1/4	2-7/8	2-5/8
	45	1/4	† 10MR41									
	70	3/16	† 10MR51									
	90	5/32	† 10MR81									
	135	1/8	† 10MR61									
1/2	45	3/8	25MR21	45	1.0	2.6	23	10	7-7/8	7-1/8	3-1/2	2-5/8
	70	5/16	25MR31									
	90	1/4	25MR41									
	135	3/16	25MR51									
	23	3/8	10MR22									
45	1/4	10MR42										
70	3/16	10MR52										
90	5/32	10MR82										
135	1/8	10MR62										
3/4	45	3/8	25MR22	45	1.0	2.7	23	10	7-7/8	7-1/8	3-1/2	2-3/4
	70	5/16	25MR32									
	90	1/4	25MR42									
	135	3/16	25MR52									
	13	1/2	10MR13									
32	5/16	10MR33										
27	1/2	25MR13	45	1.0	2.8	23	11	8-1/8	7-1/4	3-1/2	2-7/8	
70	5/16	25MR33										

† UL Listed Valves - Consult Factory

## MAGNATROL VALVE CORPORATION





# BRONZE SOLENOID VALVES

Dependable • Packless

## TYPE "S" FULL PORT - NORMALLY CLOSED 1/2" TO 3" PIPE SIZE

**NO DIFFERENTIAL PRESSURE REQUIRED TO OPEN**

MAX. FLUID TEMP.  
**400° F**  
MAX. STATIC PRESSURE  
**200 PSI**



FOR OPTIONS & ACCESSORIES  
SEE PAGES 24 & 25

**OPERATION:**

Valve opens when energized and closes when de-energized. When the coil is energized the pilot valve opens, relieving the pressure above the piston, which is then lifted from its seat by the plunger. Upon de-energizing the coil, a spring closes the pilot valve and opens a bleed passageway to permit pressure to build above the piston and seat it.

**CONSTRUCTION:** (\* Wetted parts)

- \*Valve Body - Cast Bronze, Globe Pattern - NPT ends
- \*Piston - Bronze
- Coil Enclosure - Malleable or Cast Iron, 1/2" NPS conduit conn.
- \*Plunger - 430 Stainless Steel
- \*Pilot Valve - 303 Stainless Steel
- \*Bonnet Tube - 304 Stainless Steel
- \*Spring - Inconel
- \*Body Seal - Non Asbestos Gasket
- \*Orifice Seal - Glass Filled Teflon
- \*AC Shading Coil - Copper
- \*Stem Pin - Inconel
- Coil - Encapsulated Class H, 18" leads

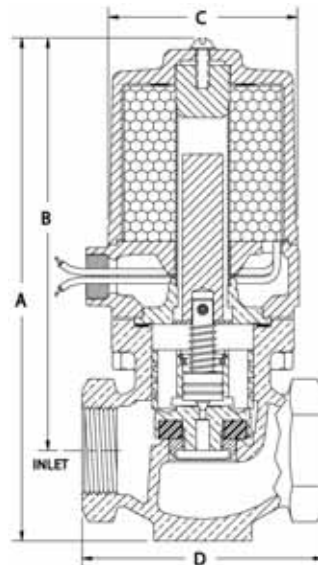

**APPLICATION:**

**TO CONTROL THE FLOW OF STEAM.** Steam must be free of sediment. Valve operates from zero to maximum differential pressure indicated in table. Valve must be mounted in horizontal pipe with solenoid enclosure vertical and on top.

Pipe Size Inches	Max. Diff. PSI	Type No.	Watts AC	Amps Hold 120-60	Amps Inrush 120-60	Watts DC	Ship Wt. Lbs.	Dimensions In Inches								
								A	B	C	D					
1/2	90	† 14S22	25	0.4	1.2	18	8	7	5-7/8	2-7/8	3-1/4					
	140	† 114S42	40	0.6	1.8	28	11	8	6-7/8	3-1/2	3-1/4					
	180	129S42	65	1.2	3.6	33	11	8	6-7/8	3-1/2	3-1/4					
3/4	50	† 14S23	25	0.4	1.3	18	9	7-1/8	6	2-7/8	3-1/2					
	110	† 114S43	40	0.6	2.0	28	12	8-1/8	7	3-1/2	3-1/2					
	180	129S43	65	1.2	3.9	33	12	8-1/8	7	3-1/2	3-1/2					
1	25	† 16S14	25	0.4	1.5	18	11	8	6-5/8	3-1/4	4-1/8					
	50	† 116S24	40	0.6	2.3	28										
	90	† 116S44	40	0.6	2.3	28										
	180	131S44	65	1.2	4.2	33						14	8-7/8	7-1/2	3-1/2	4-1/8
1-1/4	25	† 17S15	25	0.4	1.6	18	12	8-3/8	6-3/4	3-1/2	4-1/2					
	50	† 117S25	40	0.6	2.4	28										
	140	132S45	65	1.2	4.5	33						16	9-3/8	7-3/4	3-5/8	4-1/2
	180	†† 140S45	85	2.0	9.2	N/A						20	10-3/8	8-3/4	4-1/2	4-1/2
1-1/2	25	35S16	45	0.8	3.2	23	20	10	8-1/8	4	4-7/8					
	50	35S26	45	0.8	3.2	23										
	90	135S46	65	1.2	4.8	33						24	11	9-1/8	4-1/2	4-7/8
	180	141S46	85	2.0	10.0	45						24	11	9-1/8	4-1/2	4-7/8
2	25	36S17	45	0.8	3.5	23	31	11	8-3/4	5-3/8	6					
	50	36S27	45	0.8	3.5	23										
	115	42S47	60	1.2	7.4	35						36	12	9-3/4	5-3/8	6
2-1/2	180	142S47	85	2.0	11.0	45	43	12-7/8	10-1/8	5-7/8	7-1/4					
	25	43S18	60	1.2	8.0	35										
	50	43S28	60	1.2	8.0	35										
	115	43S48	60	1.2	8.0	35										
3	175	143S48	85	2.0	12.0	45	56	13-3/4	10-1/2	6-5/8	8-3/8					
	25	44S19	60	1.2	8.8	35										
	50	44S29	60	1.2	8.8	35										
	100	44S49	60	1.2	8.8	35										
150	144S49	85	2.0	13.0	45	56	13-3/4	10-1/2	6-5/8	8-3/8						

Strainers are recommended for use with solenoid valves (See page 19)

**When you order please supply the following:**

- Pipe Size
  - Valve Type
  - Voltage (AC or DC)
  - Hertz
  - Fluid
  - Fluid Temperature
  - Max. Diff. Pressure
  - Optional Features
- (See pages 24 & 25)

† UL Listed Valves - Consult Factory    †† Not available for DC operation

# BRONZE SOLENOID VALVES

Dependable • Packless



## TYPE "SR" FULL PORT - NORMALLY OPEN 1/2" TO 3" PIPE SIZE

*NO DIFFERENTIAL PRESSURE REQUIRED TO OPEN*

### OPERATION:

Valve closes when energized and opens when de-energized. When the coil is energized the plunger presses the poppet, closing the pilot orifice, and opens a bleed passageway to permit pressure to build above the piston and seat it. Upon de-energizing the coil, the pilot orifice is opened, relieving the pressure above the piston allowing it to leave its seat. The bottom spring allows the valve to operate at zero pressure drop.

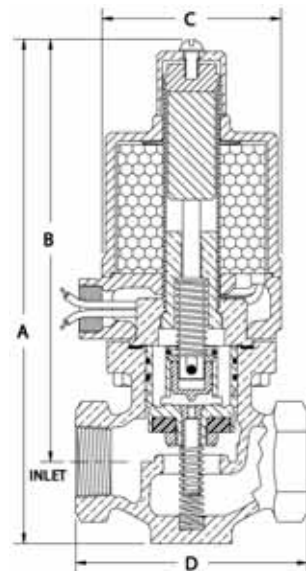

### CONSTRUCTION: (\* Wetted parts)

- \*Valve Body - Cast Bronze, Globe Pattern - NPT ends
- \*Piston - Bronze
- Coil Enclosure - Malleable or Cast Iron, 1/2" NPS conduit conn.
- \*Plunger - 430 Stainless Steel
- \*Poppet - 303 Stainless Steel
- \*Stem - 303 Stainless Steel
- \*Bonnet Tube - 304 Stainless Steel
- \*Springs - Inconel and 302 Stainless Steel
- \*Body Seal - Non Asbestos Gasket
- \*Orifice Seal - Glass Filled Teflon
- \*AC Shading Coil - Copper
- \*Stem Pin - 304 Stainless Steel
- Coil - Encapsulated Class H, 18" leads



MAX. FLUID TEMP.

**400° F**

MAX. STATIC PRESSURE

**200 PSI**

### APPLICATION:

**TO CONTROL THE FLOW OF STEAM.** Steam must be free of sediment. Valve operates from zero to maximum differential pressure indicated in table. Valve must be mounted in horizontal pipe with solenoid enclosure vertical and on top.

**FOR OPTIONS & ACCESSORIES  
SEE PAGES 24 & 25**

Strainers are recommended for use with solenoid valves (See page 19)

**When you order please supply the following:**

- Pipe Size
- Valve Type
- Voltage (AC or DC)
- Hertz
- Fluid
- Fluid Temperature
- Max. Diff. Pressure
- Optional Features

(See pages 24 & 25)

Pipe Size Inches	Max. Diff. PSI	Type No.	Watts AC	Amps Hold 120-60	Amps Inrush 120-60	Watts DC	Ship Wt. Lbs.	Dimensions In Inches								
								A	B	C	D					
1/2	90	† 14SR22	25	0.5	1.5	18	8	8-1/8	7	2-7/8	3-1/4					
	140	† 114SR42	40	0.8	2.4	28	11	9-1/8	8	3-1/2	3-1/4					
	180	129SR42	65	1.5	4.2	33	11	9-1/8	8	3-1/2	3-1/4					
3/4	50	† 14SR23	25	0.5	1.6	18	9	8-1/4	7-1/8	2-7/8	3-1/2					
	110	† 114SR43	40	0.8	2.6	28	13	9-1/4	8-1/8	3-1/2	3-1/2					
	180	129SR43	65	1.5	4.3	33	13	9-1/4	8-1/8	3-1/2	3-1/2					
1	25	† 16SR14	25	0.5	1.8	18	11	9-1/8	7-3/4	3-1/4	4-1/8					
	50	† 116SR24	40	0.8	2.9	28										
	90	† 116SR44	40	0.8	2.9	28										
	180	131SR44	65	1.5	4.5	33						15	10	8-5/8	3-1/2	4-1/8
1-1/4	25	† 17SR15	25	0.5	1.9	18	13	9-3/4	8-1/8	3-1/2	4-1/2					
	50	† 117SR25	40	0.8	3.0	28										
	140	132SR45	65	1.5	4.8	33						17	10-3/4	9-1/8	3-5/8	4-1/2
	180	†† 140SR45	85	3.5	9.0	N/A						20	11	9-3/8	4-1/2	4-1/2
1-1/2	25	35SR16	45	1.0	3.8	23	21	11-3/8	9-1/2	4	4-7/8					
	50	35SR26	45	1.0	3.8	23										
	90	135SR46	65	1.5	5.7	33										
	180	141SR46	85	3.5	9.7	45						25	11-5/8	9-3/4	4-1/2	4-7/8
2	25	36SR17	45	1.0	4.2	23	31	12-3/8	10-1/8	5-3/8	6					
	50	6SR27	45	1.0	4.2	23										
	115	42SR47	60	1.7	7.3	35						36	12-5/8	10-3/8	5-3/8	6
180	142SR47	85	3.5	11.0	45											
2-1/2	25	43SR18	60	1.7	8.0	35	45	13-1/2	10-3/4	5-7/8	7-1/4					
	50	43SR28	60	1.7	8.0	35										
	115	43SR48	60	1.7	8.0	35										
	175	143SR48	85	3.5	12.0	45										
3	25	44SR19	60	1.7	8.8	35	57	14-3/8	11-1/8	6-5/8	8-3/8					
	50	44SR29	60	1.7	8.8	35										
	100	44SR49	60	1.7	8.8	35										
	150	144SR49	85	3.5	13.0	45										

† UL Listed Valves - Consult Factory    †† Not available for DC operation

## MAGNATROL VALVE CORPORATION

Magnatrol Valve Corporation • P.O. Box 17 • 67 Fifth Avenue • Hawthorne • New Jersey • 07507  
info@magnatrol.com • Phone: 973-427-4341 • Fax: 973-427-7611 • www.magnatrol.com



# BRONZE SOLENOID VALVES

Dependable • Packless

## TYPE "L" FULL PORT - NORMALLY CLOSED 1/2" TO 3" PIPE SIZE

*NO DIFFERENTIAL PRESSURE REQUIRED TO OPEN*

**MAX. FLUID TEMP.**  
**400° F**

**MAX. STATIC PRESSURE**  
**300 PSI**

Except valves listed for 500 PSI



**OPERATION:**

Valve opens when energized and closes when de-energized. When the coil is energized the pilot valve opens, relieving the pressure above the piston, which is then lifted from its seat by the plunger. Upon de-energizing the coil, a spring closes the pilot valve and opens a bleed passageway to permit pressure to build above the piston and seat it.

**CONSTRUCTION:** (\* Wetted parts)

- \*Valve Body - Cast Bronze, Globe Pattern - NPT ends
- \*Piston - Bronze
- Coil Enclosure - Malleable or Cast Iron, 1/2" NPS conduit conn.
- \*Plunger - 430 Stainless Steel
- \*Pilot Valve - 303 Stainless Steel
- \*Bonnet Tube - 304 Stainless Steel
- \*Spring - Inconel
- \*Body Seal - Non Asbestos Gasket
- \*Orifice Seal - Glass Filled Teflon
- \*AC Shading Coil - Copper
- \*Stem Pin - Inconel
- Coil - Encapsulated Class H, 18" leads

**FOR OPTIONS &  
ACCESSORIES  
SEE PAGES 24 & 25**

**FOR  
STEAM APPLICATIONS  
SEE BULLETIN 3006-S  
Page 12**

**APPLICATION:**

To control the flow of Hot Liquids, Hot Gases, Cryogenics\*\* and any other fluids not reactive with construction materials and free of sediment. Cryogenic fluids include Liquid Oxygen (-297°F), Liquid Argon (-303°F) and Liquid Nitrogen (-320°F). Valve operates from zero to maximum differential pressure indicated in table. Valve must be mounted in horizontal pipe with solenoid enclosure vertical and on top.

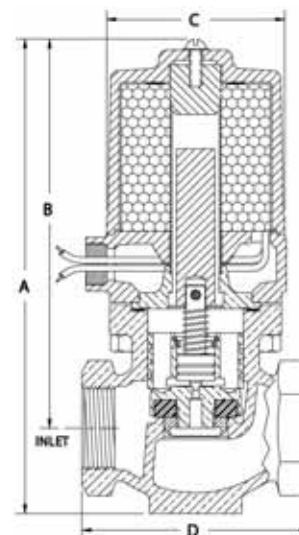

Pipe Size Inches	Max. Diff. PSI	Type No.	Watts AC	Amps Hold 120-60	Amps Inrush 120-60	Watts DC	Ship Wt. Lbs.	Dimensions In Inches			
								A	B	C	D
<b>1/2</b>	110	14L42	25	0.4	1.2	18	8	7	5-7/8	2-7/8	3-1/4
	200	14L32	25	0.4	1.3	18	9	7-1/8	6	2-7/8	3-1/2
	300	29L52	45	0.8	2.4	23	11	8	6-7/8	3-1/2	3-1/4
	500	E29L62	45	0.8	2.4	23	16	8	6-7/8	4	3-1/4
<b>3/4</b>	50	14L23	25	0.4	1.3	18	9	7-1/8	6	2-7/8	3-1/2
	110	14L43	25	0.4	1.3	18	9	7-1/8	6	2-7/8	3-1/2
	200	29L33	45	0.8	2.6	23	12	8-1/8	7	3-1/2	3-1/2
	300	129L53	65	1.2	3.9	33	17	8-1/8	7	4	3-1/2
	500	E129L63	65	1.2	3.9	33	17	8-1/8	7	4	3-1/2
<b>1</b>	50	16L24	25	0.4	1.5	18	11	8	6-5/8	3-1/4	4-1/8
	110	16L44	25	0.4	1.5	18	11	8	6-5/8	3-1/4	4-1/8
	200	31L34	45	0.8	2.8	23	14	8-7/8	7-1/2	3-1/2	4-1/8
	300	131L54	65	1.2	4.2	33	19	8-7/8	7-1/2	4	4-1/8
	500	E131L64	65	1.2	4.2	33	19	8-7/8	7-1/2	4	4-1/8
<b>1-1/4</b>	50	17L25	25	0.4	1.6	18	12	8-3/8	6-3/4	3-1/2	4-1/2
	90	17L45	25	0.4	1.6	18	12	8-3/8	6-3/4	3-1/2	4-1/2
	200	32L35	45	0.8	3.0	23	16	9-3/8	7-3/4	3-5/8	4-1/2
	300	132L55	65	1.2	4.5	33	20	10-3/8	8-3/4	4-1/2	4-1/2
	500	†† 140L65	85	2.0	9.2	N/A	20	10-3/8	8-3/4	4-1/2	4-1/2
<b>1-1/2</b>	50	35L26	45	0.8	3.2	23	20	10	8-1/8	4	4-7/8
	115	35L46	45	0.8	3.2	23	20	10	8-1/8	4	4-7/8
	200	41L36	60	1.2	6.7	35	24	11	9-1/8	4-1/2	4-7/8
	300	141L56	85	2.0	10.0	45	24	11	9-1/8	4-1/2	4-7/8
	500	141L66	85	2.0	10.0	45	24	11	9-1/8	4-1/2	4-7/8
<b>2</b>	50	36L27	45	0.8	3.5	23	31	11	8-3/4	5-3/8	6
	100	36L47	45	0.8	3.5	23	31	11	8-3/4	5-3/8	6
	200	42L37	60	1.2	7.4	35	36	12	9-3/4	5-3/8	6
	300	42L57	60	1.2	7.4	35	36	12	9-3/4	5-3/8	6
	500	142L67	85	2.0	11.0	45	36	12	9-3/4	5-3/8	6
<b>2-1/2</b>	50	43L28	60	1.2	8.0	35	43	12-7/8	10-1/8	5-7/8	7-1/4
	125	43L48	60	1.2	8.0	35	43	12-7/8	10-1/8	5-7/8	7-1/4
	200	43L38	60	1.2	8.0	35	43	12-7/8	10-1/8	5-7/8	7-1/4
	300	143L58	85	2.0	12.0	45	43	12-7/8	10-1/8	5-7/8	7-1/4
	500	143L58	85	2.0	12.0	45	43	12-7/8	10-1/8	5-7/8	7-1/4
<b>3</b>	50	44L29	60	1.2	8.8	35	56	13-3/4	10-1/2	6-5/8	8-3/8
	100	44L49	60	1.2	8.8	35	56	13-3/4	10-1/2	6-5/8	8-3/8
	200	44L39	60	1.2	8.8	35	56	13-3/4	10-1/2	6-5/8	8-3/8
	300	144L59	85	2.0	13.0	45	56	13-3/4	10-1/2	6-5/8	8-3/8
	500	144L59	85	2.0	13.0	45	56	13-3/4	10-1/2	6-5/8	8-3/8

†† Not available for DC operation

**\*\* CLEANING**

- Cryogenic valves are degreased & cleaned to keep them free of moisture.
- Oxygen valves are also "black light" tested.

Strainers are recommended for use with solenoid valves

(See page 19)

**When you order please supply the following:**

- Pipe Size
- Valve Type
- Voltage (AC or DC)
- Hertz
- Fluid
- Fluid Temperature
- Max. Diff. Pressure
- Optional Features

(See pages 24 & 25)



# BRONZE SOLENOID VALVES

Dependable • Packless



## TYPE "LR" FULL PORT - NORMALLY OPEN 1/2" TO 3" PIPE SIZE

**NO DIFFERENTIAL PRESSURE REQUIRED TO OPEN**

**OPERATION:**

Valve closes when energized and opens when de-energized. When the coil is energized the plunger presses the poppet, closing the pilot orifice, and opens a bleed passageway to permit pressure to build above the piston and seal it. Upon de-energizing the coil, the pilot orifice is opened, relieving the pressure above the piston allowing it to leave its seat. The bottom spring allows the valve to operate at zero pressure drop.

**MAX. FLUID TEMP.  
400° F**

**MAX. STATIC PRESSURE  
300 PSI**

Except valves listed for 500 PSI

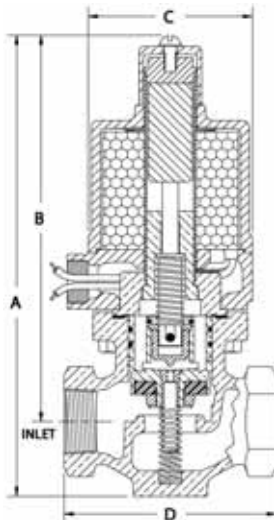

**CONSTRUCTION:** (\* Wetted parts)

- \*Valve Body - Cast Bronze, Globe Pattern - NPT ends
- \*Piston - Bronze
- Coil Enclosure - Malleable or Cast Iron, 1/2" NPS conduit conn.
- \*Plunger - 430 Stainless Steel
- \*Poppet - 303 Stainless Steel
- \*Stem - 303 Stainless Steel
- \*Bonnet Tube - 304 Stainless Steel
- \*Springs - Inconel and 302 Stainless Steel
- \*Body Seal - Non Asbestos Gasket
- \*Orifice Seal - Glass Filled Teflon
- \*AC Shading Coil - Copper
- \*Stem Pin - 304 Stainless Steel
- Coil - Encapsulated Class H, 18" leads

**FOR OPTIONS &  
ACCESSORIES  
SEE PAGES 24 & 25**

**FOR  
STEAM APPLICATIONS  
SEE BULLETIN 3006-SR  
Page 13**



**APPLICATION:**

To control the flow of Hot Liquids, Hot Gases, Cryogenics\*\* and any other fluids not reactive with construction materials and free of sediment. Cryogenic fluids include Liquid Oxygen (-297°F), Liquid Argon (-303°F) and Liquid Nitrogen (-320°F). Valve operates from zero to maximum differential pressure indicated in table. Valve must be mounted in horizontal pipe with solenoid enclosure vertical and on top.

**\*\* CLEANING**

- Cryogenic valves are degreased & cleaned to keep them free of moisture.
- Oxygen valves are also "black light" tested.

Strainers are recommended for use with solenoid valves

(See page 19)

**When you order please supply the following:**

- Pipe Size
- Valve Type
- Voltage (AC or DC)
- Hertz
- Fluid
- Fluid Temperature
- Max. Diff. Pressure
- Optional Features

(See pages 24 & 25)

Pipe Size Inches	Max. Diff. PSI	Type No.	Watts AC	Amps Hold 120-60	Amps Inrush 120-60	Watts DC	Ship Wt. Lbs.	Dimensions In Inches			
								A	B	C	D
1/2	110	14LR42	25	0.5	1.5	18	8	8-1/8	7	2-7/8	3-1/4
	200	14LR32									
	300	29LR52	45	1.0	2.7	23	11	9-1/8	8	3-1/2	3-1/4
3/4	50	14LR23	25	0.5	1.6	18	9	8-1/4	7-1/8	2-7/8	3-1/2
	110	14LR43									
	200	29LR33	45	1.0	2.9	23	13	9-1/4	8-1/8	3-1/2	3-1/2
	300	129LR53	65	1.5	4.3	33					
	500	E129LR63	65	1.5	4.3	33	18	9-1/4	8-1/8	4	3-1/2
1	50	16LR24	25	0.5	1.8	18	11	9-1/8	7-3/4	3-1/4	4-1/8
	110	16LR44									
	200	31LR34	45	1.0	3.0	23	15	10	8-5/8	3-1/2	4-1/8
	300	131LR54	65	1.5	4.5	33					
500	E131LR64	65	1.5	4.5	33	20	10	8-5/8	4	4-1/8	
1-1/4	50	17LR25	25	0.5	1.9	18	13	9-3/4	8-1/8	3-1/2	4-1/2
	90	17LR45									
	200	32LR35	45	1.0	3.2	23	17	10-3/4	9-1/8	3-5/8	4-1/2
	300	132LR55	65	1.5	4.8	33					
500	††140LR65	85	3.5	9.0	N/A	20	11	9-3/8	4-1/2	4-1/2	
1-1/2	50	35LR26	45	1.0	3.8	23	21	11-3/8	9-3/8	4	4-7/8
	115	35LR46									
	200	41LR36	60	1.7	6.5	35	25	11-5/8	9-3/4	4-1/2	4-7/8
	300	141LR56	85	3.5	9.7	45					
500	141LR66										
2	50	36LR27	45	1.0	4.2	23	31	12-3/8	10-1/8	5-3/8	6
	100	36LR47									
	200	42LR37	60	1.7	7.3	35	36	12-5/8	10-3/8	5-3/8	6
	300	42LR57	85	3.5	11.0	45					
500	142LR67										
2-1/2	50	43LR28	60	1.7	8.0	35	45	13-1/2	10-3/4	5-7/8	7-1/4
	125	43LR48									
	200	43LR38									
	300	143LR58	85	3.5	12.0	45					
3	50	44LR29	60	1.7	8.8	35	57	14-3/8	11-1/8	6-5/8	8-3/8
	100	44LR49									
	200	44LR39									
	300	144LR59	85	3.5	13.0	45					

†† Not available for DC operation

**MAGNATROL VALVE CORPORATION**



# BRONZE SOLENOID VALVES

Dependable • Packless

MAX. FLUID TEMP.  
**212° F**  
MAX. STATIC PRESSURE  
**150 PSI**

## TYPE "G" FULL PORT - NORMALLY CLOSED 1" TO 3" PIPE SIZE

*NO DIFFERENTIAL PRESSURE REQUIRED TO OPEN*

**OPERATION:**

Valve opens when energized and closes when de-energized. When the coil is energized the pilot valve opens, relieving the pressure above the piston, which is then lifted from its seat by the plunger. Upon de-energizing the coil, a spring closes the pilot valve and opens a bleed passageway to permit pressure to build above the piston and seat it.

**CONSTRUCTION:** (\* Wetted parts)

- \*Valve Body - Cast Bronze, Globe Pattern - NPT ends
- \*Piston - Bronze
- Coil Enclosure - Malleable or Cast Iron, 1/2" NPS conduit conn.
- \*Plunger - 430 Stainless Steel
- \*Pilot Valve Stem - 303 Stainless Steel
- \*Pilot Valve Disc Holder - Brass
- \*Pilot Valve Seal - Buna N (Viton available)
- \*Bonnet Tube - 304 Stainless Steel
- \*Spring - 302 Stainless Steel
- \*Body Seal - Buna N or Non Asbestos Gasket
- \*Orifice Seal - Buna N (Viton or Glass Filled Teflon available)
- \*AC Shading Coil - Copper
- \*Stem Pin - Inconel
- Coil - Encapsulated Class B, 18" leads - (Class H available)

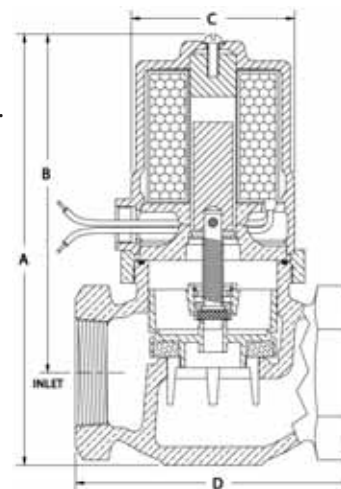

**APPLICATION:**

**To control the flow of Water, Air, Gas, Solvents, Vacuum** and any other fluids not reactive with construction materials and free of sediment. Buna N seating of the pilot and main orifices make the valves ideal for TIGHT SEATING, LOW PRESSURE and LOW FLOW conditions. Valve operates from zero to maximum differential pressure indicated in table. Valve must be mounted in horizontal pipe with solenoid enclosure vertical and on top.

Strainers are recommended for use with solenoid valves  
(See page 19)

**FOR OPTIONS & ACCESSORIES  
SEE PAGES 24 & 25**

Pipe Size Inches	Max. Diff. PSI	Type No.	Watts AC	Amps Hold 120-60	Amps Inrush 120-60	Watts DC	Ship Wt. Lbs.	Dimensions In Inches			
								A	B	C	D
<b>1</b>	20	† 18G24	25	0.4	1.4	18	9	7-1/2	6-1/8	2-3/4	4-1/8
	30	118G24	40	0.6	2.3	28	9	7-1/2	6-1/8	2-3/4	4-1/8
	50	133G24	65	1.2	4.0	33	13	8-1/2	7-1/8	3-1/2	4-1/8
<b>1-1/4</b>	20	† 18G25	25	0.4	1.5	18	10	8	6-3/8	2-7/8	4-3/8
	30	118G25	40	0.6	2.4	28	10	8	6-3/8	2-7/8	4-3/8
	50	133G25	65	1.2	4.1	33	14	8-7/8	7-3/8	3-1/2	4-3/8
<b>1-1/2</b>	15	† 18G26	25	0.4	1.7	18	12	8-1/8	6-1/2	3-1/8	4-3/4
	25	118G26	40	0.6	2.5	28	12	8-1/8	6-1/2	3-1/8	4-3/4
	35	133G26	65	1.2	4.2	33	16	9-1/8	7-1/2	3-1/2	4-3/4
<b>2</b>	18	33G27	45	0.8	3.4	23	20	9-7/8	7-7/8	3-3/4	5-3/4
	30	133G27	65	1.2	4.2	33	20	9-7/8	7-7/8	3-3/4	5-3/4
	50	233G27	80	1.8	9.0	40	20	9-7/8	7-7/8	3-3/4	5-3/4
<b>2-1/2</b>	13	37G28	40	0.8	3.6	23	33	11-1/8	8-5/8	5-7/8	7-1/8
	25	43G28	60	1.2	7.8	35	38	12-1/8	9-5/8	5-7/8	7-1/8
	35	143G28	85	2.0	12.0	45	38	12-1/8	9-5/8	5-7/8	7-1/8
<b>3</b>	25	44G29	60	1.2	8.6	35	46	13	10	6-5/8	8
	35	144G29	85	2.0	13.0	45	46	13	10	6-5/8	8

**When you order please supply the following:**

- Pipe Size
- Valve Type
- Voltage (AC or DC)
- Hertz
- Fluid
- Fluid Temperature
- Max. Diff. Pressure
- Optional Features

(See pages 24 & 25)

† UL Listed Valves - Consult Factory

**MAGNATROL VALVE CORPORATION**

Magnatrol Valve Corporation • P.O. Box 17 • 67 Fifth Avenue • Hawthorne • New Jersey • 07507  
info@magnatrol.com • Phone: 973-427-4341 • Fax: 973-427-7611 • www.magnatrol.com

# BRONZE SOLENOID VALVES

Dependable • Packless



## TYPE "GR" FULL PORT - NORMALLY OPEN 1" TO 3" PIPE SIZE

*NO DIFFERENTIAL PRESSURE REQUIRED TO OPEN*

MAX. FLUID TEMP.  
**212° F**  
MAX. STATIC PRESSURE  
**150 PSI**

**OPERATION:**

Valve closes when energized and opens when de-energized. When the coil is energized the plunger presses the poppet, closing the pilot orifice, and opens a bleed passageway to permit pressure to build above the piston and seat it. Upon de-energizing the coil, the pilot orifice is opened, relieving the pressure above the piston allowing it to leave its seat. The bottom spring allows the valve to operate at zero pressure drop.

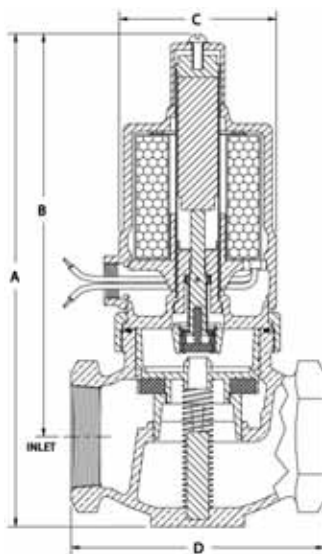

Strainers are recommended for use with solenoid valves (See page 19)

**CONSTRUCTION:** (\* Wetted parts)

- \*Valve Body - Cast Bronze, Globe Pattern - NPT ends
- \*Piston - Bronze  
Coil Enclosure - Malleable or Cast Iron, 1/2" NPS conduit conn.
- \*Plunger - 430 Stainless Steel
- \*Pilot Valve Stem - 303 Stainless Steel
- \*Pilot Valve Disc Holder - Brass
- \*Pilot Valve Seal - Buna N (Viton available)
- \*Bonnet Tube - 304 Stainless Steel
- \*Spring - 302 Stainless Steel
- \*Body Seal - Buna N or Non Asbestos Gasket
- \*Orifice Seal - Buna N (Viton or Glass Filled Teflon available)
- \*AC Shading Coil - Copper
- \*Stem Pin - 304 Stainless Steel  
Coil - Encapsulated Class B, 18" leads - (Class H available)



**APPLICATION:**

To control the flow of Water, Air, Gas, Solvents, Vacuum and any other fluids not reactive with construction materials and free of sediment. Buna N seating of the pilot and main orifices make the valves ideal for TIGHT SEATING, LOW PRESSURE and LOW FLOW conditions. Valve operates from zero to maximum differential pressure indicated in table. Valve must be mounted in horizontal pipe with solenoid enclosure vertical and on top.

FOR OPTIONS & ACCESSORIES  
SEE PAGES 24 & 25

**When you order please supply the following:**

- Pipe Size
  - Valve Type
  - Voltage (AC or DC)
  - Hertz
  - Fluid
  - Fluid Temperature
  - Max. Diff. Pressure
  - Optional Features
- (See pages 24 & 25)

Pipe Size Inches	Max. Diff. PSI	Type No.	Watts AC	Amps Hold 120-60	Amps Inrush 120-60	Watts DC	Ship Wt. Lbs.	Dimensions In Inches			
								A	B	C	D
1	20	† 18GR24	25	0.5	1.5	18	9	8-5/8	7-1/4	2-3/4	4-1/8
	35	33GR24	45	1.0	3.0	23	13	9-5/8	8-1/4	3-1/2	4-1/8
1-1/4	20	† 18GR25	25	0.5	1.9	18	10	9-3/8	7-3/4	2-7/8	4-3/8
	35	33GR25	45	1.0	3.2	23	14	10-1/4	8-3/4	3-1/2	4-3/8
1-1/2	15	† 18GR26	25	0.5	2.0	18	12	9-1/2	7-7/8	3-1/8	4-3/4
	25	33GR26	45	1.0	3.8	23	16	10-1/2	8-7/8	3-1/2	4-3/4
2	18	33GR27	45	1.0	4.2	23	21	11-1/4	9-1/4	3-3/4	5-3/4
	30	133GR27	65	1.5	4.5	33	21	11-1/4	9-1/4	3-3/4	5-3/4
2-1/2	13	37GR28	45	1.0	4.4	23	34	12-1/2	10	5-7/8	7-1/8
	25	43GR28	60	1.7	8.0	35	39	12-3/4	10-1/4	5-7/8	7-1/8
3	25	44GR29	60	1.7	8.8	35	47	13-5/8	10-5/8	6-5/8	8

† UL Listed Valves - Consult Factory

**MAGNATROL VALVE CORPORATION**





# BRONZE SOLENOID VALVES

Dependable • Packless

## TYPE "D" FULL PORT - NORMALLY CLOSED 3/8" TO 2" PIPE SIZE

**NO DIFFERENTIAL PRESSURE REQUIRED TO OPEN**

MAX. FLUID TEMP.  
**212° F**  
MAX. STATIC PRESSURE  
**150 PSI**

**OPERATION:**

Valve opens when energized and closes when de-energized. In this direct acting valve the disc holder assembly is lifted from its seat by the plunger.

**CONSTRUCTION:** (\* Wetted parts)

- \*Valve Body - Cast Bronze, Globe Pattern - NPT ends
- \*Disc Holder - Brass
- Coil Enclosure - Malleable or Cast Iron, 1/2" NPS conduit conn.
- \*Plunger - 430 Stainless Steel
- \*Stem - 303 Stainless Steel
- \*Bonnet Tube - 304 Stainless Steel
- \*Spring - 302 Stainless Steel
- \*Body Seal - Buna N
- \*Orifice Seal - Buna N (Viton or Glass Filled Teflon available)
- \*AC Shading Coil - Copper
- \*Stem Pin - Inconel
- Coil - Encapsulated Class B, 18" leads - (Class H available)

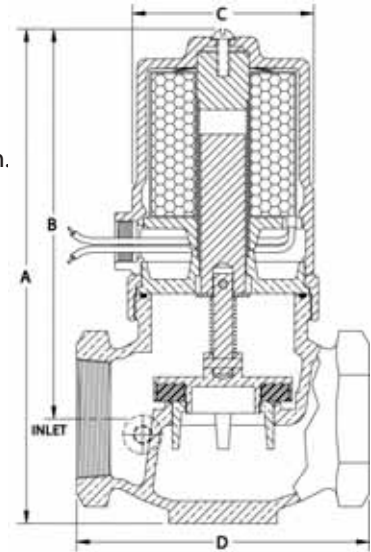

**APPLICATION:**

To control the flow of Water, Air, Gas, Solvents, Vacuum and any other fluids not reactive with construction materials and free of sediment. Buna N seating of the main orifice make the valves ideal for TIGHT SEATING, LOW PRESSURE and LOW FLOW conditions. Valve operates from zero to maximum differential pressure indicated in table. Valve must be mounted in horizontal pipe with solenoid enclosure vertical and on top.

Strainers are recommended for use with solenoid valves (See page 19)

FOR OPTIONS & ACCESSORIES  
SEE PAGES 24 & 25



Pipe Size Inches	Max. Diff. PSI	Type No.	Watts AC	Amps Hold 120-60	Amps Inrush 120-60	Watts DC	Ship Wt. Lbs.	Dimensions In Inches			
								A	B	C	D
3/8	15	18D11	25	0.4	1.0	18	7	6-1/4	5-3/8	2-3/4	2-7/8
	30	33D11	45	0.8	2.3	23	10	7-1/8	6-3/8	3-1/2	2-7/8
1/2	10	18D12	25	0.4	1.1	18	7	6-1/4	5-1/2	2-3/4	3-1/8
	20	33D12	45	0.8	2.4	23	10	7-1/4	6-3/8	3-1/2	3-1/8
3/4	4	18D13	25	0.4	1.2	18	8	6-7/8	5-3/4	2-3/4	3-1/2
	7.5	33D13	45	0.8	2.5	23	12	7-3/4	6-3/4	3-1/2	3-1/2
1	2	18D14	25	0.4	1.4	18	9	7-1/2	6-1/8	2-3/4	4-1/8
	3.5	33D14	45	0.8	2.7	23	13	8-1/2	7-1/8	3-1/2	4-1/8
1-1/4	1.3	18D15	25	0.4	1.5	18	10	8	6-3/8	2-7/8	4-3/8
	2.3	33D15	45	0.8	2.8	23	14	8-7/8	7-3/8	3-1/2	4-3/8
1-1/2	0.8	18D16	25	0.4	1.7	18	12	8-1/8	6-1/2	3-1/8	4-3/4
	1.5	33D16	45	0.8	3.0	23	15	9-1/8	7-1/2	3-1/2	4-3/4
2	0.8	33D17	45	0.8	3.4	23	19	9-7/8	7-7/8	3-3/4	5-3/4
	1.2	†133D17	65	1.2	4.2	33	19	9-7/8	7-7/8	3-3/4	5-3/4

**When you order please supply the following:**

- Pipe Size
- Valve Type
- Voltage (AC or DC)
- Hertz
- Fluid
- Fluid Temperature
- Max. Diff. Pressure
- Optional Features

(See pages 24 & 25)

† UL Listed Valves - Consult Factory

# STRAINERS

Bronze • Stainless Steel



**APPLICATION:**

The presence of foreign particles in an automatic valve may seriously affect its dependability. The installation of a strainer close to the inlet side of the valve is the best means of preventing the entrance of pipe chips, scale, rust, pipe dope, welding slag or sediment into the valve, provided the screen is periodically removed for cleaning.

**CONSTRUCTION:**

Strainer bodies have screwed ends. Screens are stainless steel with opening sizes as listed in tables below. Other sizes can be furnished upon request. Liberal straining area provides for fluid passage at minimum pressure drop. Screens are easily removed for cleaning. Strainers are furnished with NPT blowoff connections unplugged. See charts below for blow-off sizes (C Dim.)

**CLEANING FOR CRYOGENIC & OXYGEN SERVICE:**

- Strainers for Cryogenic applications are degreased and cleaned to keep them free of moisture.
- Strainers for Oxygen service are degreased and cleaned then “black light” tested.



**BRONZE 1/4" TO 3" PIPE SIZE**

Pipe Size Inches	Screen Size	Type No.	Ship Wt. Lbs.	Dimensions In Inches		
				A	B	C
1/4	60 Mesh 0.009 Openings	ST 0	3/4	2-3/4	2-1/4	1/4
3/8		ST 1	3/4	2-3/4	2-1/4	1/4
1/2		ST 2	3/4	2-3/4	2-1/4	1/4
3/4		ST 3	1-1/2	3	2-9/16	3/8
1	0.16 Diameter Perforations Lined With 30 Mesh	ST 4	2-1/4	3-3/4	2-3/4	3/8
1-1/4		ST 5	3-1/4	4-7/16	3-5/8	3/4
1-1/2		ST 6	4-1/2	4-15/16	3-7/8	3/4
2		ST 7	7	6-1/8	5-1/16	1
2-1/2		ST 8	12-1/2	8-1/4	6	1-1/4
3	ST 9	18	9	6-3/4	1-1/2	

**STAINLESS STEEL 1/2" TO 2" PIPE SIZE**

Pipe Size Inches	Screen Size	Type No.	Ship Wt. Lbs.	Dimensions In Inches		
				A	B	C
1/2	60 Mesh 0.009 Openings	ST 2SS	1-1/2	3	2-3/8	1/4
3/4		ST 3SS	2-1/4	3-3/4	2-13/16	3/8
1		ST 4SS	3-1/4	4-5/8	3-1/8	3/8
1-1/2	0.16 Diameter Perforations Lined w/30 Mesh	ST 6SS	6-3/4	5-5/8	4-3/4	3/4
2		ST 7SS	11-1/2	7	6	1

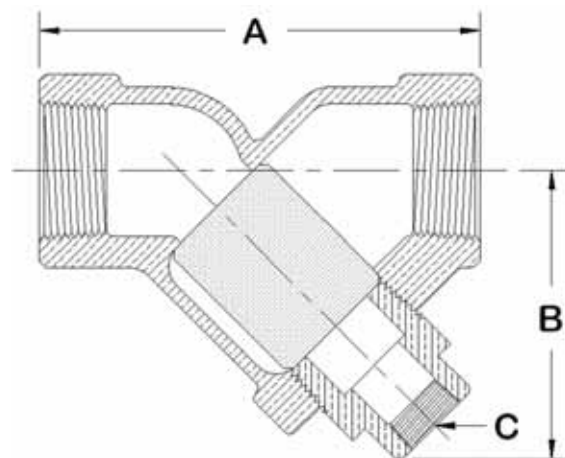

**PRESSURE TEMPERATURE RATINGS**

MATERIAL	STEAM	LIQUIDS
BRONZE	300 PSI @ 400°F	600 PSI @ 100°F
STAINLESS STEEL	845 PSI @ 750°F	1,440 PSI @ 100°F



# STAINLESS STEEL SOLENOID VALVES

Dependable • Packless

## TYPE "K" FULL PORT - NORMALLY CLOSED 1/2" TO 2" PIPE SIZE

*NO DIFFERENTIAL PRESSURE REQUIRED TO OPEN*

**MAX. FLUID TEMP.**  
**400° F**  
**MAX. STATIC PRESSURE**  
**300 PSI**  
Except valves listed for 500 PSI

**OPERATION:**

Valve opens when energized and closes when de-energized. When the coil is energized the pilot valve opens, relieving the pressure above the piston, which is then lifted from its seat by the plunger. Upon de-energizing the coil, a spring closes the pilot valve and opens a bleed passageway to permit pressure to build above the piston and seat it.

**CONSTRUCTION:**

- (\*Wetted parts - No Copper Bearing Alloys in contact with fluid)
- \*Valve Body - 304 Stainless Steel Globe Pattern - NPT ends  
**(For Flanged Ends see Options page 24)**
- \*Piston - 303 Stainless Steel
- Coil Enclosure - Malleable or Cast Iron, 1/2" NPS conduit conn.
- \*Plunger - 430 Stainless Steel
- \*Pilot Valve - 303 Stainless Steel
- \*Bonnet Tube - 304 Stainless Steel
- \*Spring - Inconel
- \*Body Seal - Non Asbestos Gasket
- \*Orifice Seal - Glass Filled Teflon
- \*AC Shading Coil - Silver
- \*Stem Pin - Inconel
- Coil - Encapsulated Class H, 18" leads

**FOR  
STEAM APPLICATIONS  
SEE BULLETIN 3006-W  
Page 22**

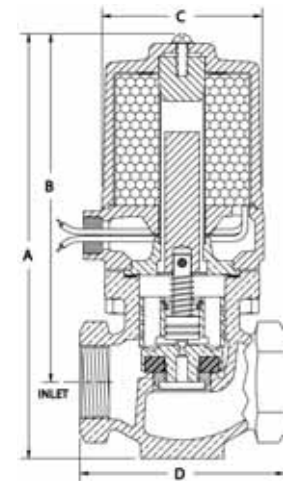

**APPLICATION:**

**To control the flow of Corrosive Fluids, Deionized Water, Condensate, Ammonias, Vegetable Oils, Fuel Oils, Cryogenics\*\*, Flammable Liquids.** Cryogenic fluids include liquid oxygen (-297°F), liquid argon (-303°F) and liquid nitrogen (-320°F). Valve operates from zero to maximum differential pressure indicated in table. Valve must be mounted in horizontal pipe with solenoid enclosure vertical and on top.

**FOR OPTIONS & ACCESSORIES  
SEE PAGES 24 & 25**

Pipe Size Inches	Max. Diff. PSI	Type No.	Watts AC	Amps Hold 120-60	Amps Inrush 120-60	Watts DC	Ship Wt. Lbs.	Dimensions In Inches			
								A	B	C	D
1/2	110	14K42	25	0.4	1.2	18	7	7	5-7/8	2-7/8	3-1/4
	200	14K32						10	6-7/8	3-1/2	
	500	E29K62	15	4	4						
3/4	110	14K43	25	0.4	1.3	18	8	7-1/8	6	2-7/8	3-1/2
	200	29K33						11	7	3-1/2	
	500	E129K63	16	4	4						
1	110	16K44	25	0.4	1.5	18	10	8	6-5/8	3-1/4	4-1/8
	200	31K34						13	7-1/2	3-1/2	
	500	E131K64	18	4	4						
1-1/2	115	35K46	45	0.8	3.2	23	17	10	8-1/8	4	4-7/8
	200	41K36						21	9-1/8	4-1/2	
	500	E141K66	21	11	4-1/2	4-7/8					
2	100	36K47	45	0.8	3.5	23	27	11	8-3/4	5-3/8	6
	200	42K37						32	9-3/4		
	500	E42K57	32	12	6						
500	142K67	85	2.0	11.0	45						

**\*\* CLEANING**

- Cryogenic valves are degreased & cleaned to keep them free of moisture.
- Oxygen valves are also "black light" tested.

Strainers are recommended for use with solenoid valves (See page 19)

**When you order please supply the following:**

- Pipe Size
- Valve Type
- Voltage (AC or DC)
- Hertz
- Fluid
- Fluid Temperature
- Max. Diff. Pressure
- Optional Features

(See pages 24 & 25)

**Face To Face Dimensions for Flanged Ends**

(For complete dimensions, weights and other sizes see Engineering Catalog 3006-ENG)

Pipe Size	Dimension In Inches	
	150# Flanged	300# Flanged
1	6-1/2	7-1/2
1-1/2	6-1/2	7-1/2
2	8	9



# STAINLESS STEEL SOLENOID VALVES

Dependable • Packless



## TYPE "KR" FULL PORT - NORMALLY OPEN 1/2" TO 2" PIPE SIZE

*NO DIFFERENTIAL PRESSURE REQUIRED TO OPEN*

### OPERATION:

Valve closes when energized and opens when de-energized. When the coil is energized the plunger presses the poppet, closing the pilot orifice, and opens a bleed passageway to permit pressure to build above the piston and seat it. Upon de-energizing the coil, the pilot orifice is opened, relieving the pressure above the piston allowing it to leave its seat. The bottom spring allows the valve to operate at zero pressure drop.

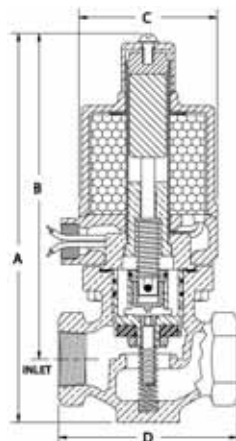

### CONSTRUCTION:

- (\*Wetted parts - No Copper Bearing Alloys in contact with fluid)
- \*Valve Body - 304 Stainless Steel Globe Pattern - NPT ends  
**(For Flanged Ends see Options page 24)**
- \*Piston - 303 Stainless Steel
- Coil Enclosure - Malleable or Cast Iron, 1/2 " NPS conduit conn.
- \*Plunger - 430 Stainless Steel
- \*Poppet - 303 Stainless Steel
- \*Stem - 303 Stainless Steel
- \*Bonnet Tube - 304 Stainless Steel
- \*Spring - Inconel
- \*Body Seal - Non Asbestos Gasket
- \*Orifice Seal - Glass Filled Teflon
- \*AC Shading Coil - Silver
- \*Stem Pin - 304 Stainless Steel
- Coil - Encapsulated Class H, 18" leads

**FOR  
STEAM APPLICATIONS  
SEE BULLETIN 3006-WR  
Page 23**



**FOR OPTIONS & ACCESSORIES  
SEE PAGES 24 & 25**

### APPLICATION:

To control the flow of **Corrosive Fluids, Deionized Water, Condensate, Ammonias, Vegetable Oils, Fuel Oils, Cryogenics\*\*, Flammable Liquids.** Cryogenic fluids include liquid oxygen (-297°F), liquid argon (-303°F) and liquid nitrogen (-320°F). Valve operates from zero to maximum differential pressure indicated in table. Valve must be mounted in horizontal pipe with solenoid enclosure vertical and on top.

### \*\* CLEANING

- Cryogenic valves are degreased & cleaned to keep them free of moisture.
- Oxygen valves are also "black light" tested.

Strainers are recommended for use with solenoid valves  
(See page 19)

### When you order please supply the following:

- Pipe Size
- Valve Type
- Voltage (AC or DC)
- Hertz
- Fluid
- Fluid Temperature
- Max. Diff. Pressure
- Optional Features

(See pages 24 & 25)

Pipe Size Inches	Max. Diff. PSI	Type No.	Watts AC	Amps Hold 120-60	Amps Inrush 120-60	Watts DC	Ship Wt. Lbs.	Dimensions In Inches			
								A	B	C	D
1/2	110	14KR42	25	0.5	1.5	18	7	8-1/8	7	2-7/8	3-1/4
	200	14KR32									
	300	29KR52	45	1.0	2.7	23	10	9-1/8	8	3-1/2	
3/4	500	E29KR62					15			4	
	110	14KR43	25	0.5	1.6	18	8	8-1/4	7-1/8	2-7/8	3-1/2
	200	29KR33	45	1.0	2.9	23					
	300	129KR53	65	1.5	4.3	33	12	9-1/4	8-1/8	3-1/2	
500	E129KR63					17			4		
1	110	16KR44	25	0.5	1.8	18	10	9-1/8	7-3/4	3-1/4	4-1/8
	200	31KR34	45	1.0	3.0	23					
	300	131KR54	65	1.5	4.5	33	14	10	8-5/8	3-1/2	
	500	E131KR64					20			4	
1-1/2	115	35KR46	45	1.0	3.8	23	18	11-3/8	9-1/2	4	4-7/8
	200	41KR36	60	1.7	6.5	35					
	300	141KR56	85	3.5	9.7	45	22	11-5/8	9-3/4	4-1/2	
	500	141KR66									
2	100	36KR47	45	1.0	4.2	23	27	12-3/8	10-1/8		6
	200	42KR37	60	1.7	7.3	35					
	300	42KR57					32	12-5/8	10-3/8	5-3/8	
	500	142KR67	85	3.5	11.0	45					

Dimension In Inches		
Pipe Size	150# Flanged	300# Flanged
1	6-1/2	7-1/2
1-1/2	6-1/2	7-1/2
2	8	9

### Face To Face Dimensions for Flanged Ends

(For complete dimensions, weights and other sizes see Engineering Catalog 3006-ENG)

## MAGNATROL VALVE CORPORATION



# STAINLESS STEEL SOLENOID VALVES

Dependable • Packless

## TYPE "W" FULL PORT - NORMALLY CLOSED 1/2" TO 2" PIPE SIZE

*NO DIFFERENTIAL PRESSURE REQUIRED TO OPEN*

**MAX. FLUID TEMP.  
400° F**  
**MAX. STATIC PRESSURE  
200 PSI**

**OPERATION:**

Valve opens when energized and closes when de-energized. When the coil is energized the pilot valve opens, relieving the pressure above the piston, which is then lifted from its seat by the plunger. Upon de-energizing the coil, a spring closes the pilot valve and opens a bleed passageway to permit pressure to build above the piston and seat it.

**CONSTRUCTION:**

(\*Wetted parts - No Copper Bearing Alloys in contact with fluid)

\*Valve Body - 304 Stainless Steel Globe Pattern - NPT ends

**(For Flanged Ends see Options page 24)**

\*Piston - 303 Stainless Steel

Coil Enclosure - Malleable or Cast Iron, 1/2" NPS conduit conn.

\*Plunger - 430 Stainless Steel

\*Pilot Valve - 303 Stainless Steel

\*Bonnet Tube - 304 Stainless Steel

\*Spring - Inconel

\*Body Seal - Non Asbestos Gasket

\*Orifice Seal - Glass Filled Teflon

\*AC Shading Coil - Silver

\*Stem Pin - Inconel

Coil - Encapsulated Class H, 18" leads

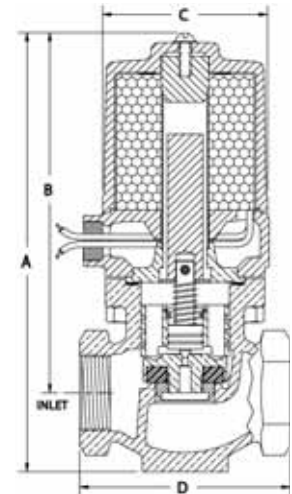

**APPLICATION:**

**To control the flow of STEAM.** Steam must be free of sediment. Valve operates from zero to maximum differential pressure indicated in table. Valve must be mounted in horizontal pipe with solenoid enclosure vertical and on top.

**FOR OPTIONS & ACCESSORIES  
SEE PAGES 24 & 25**

Pipe Size Inches	Max. Diff. PSI	Type No.	Watts AC	Amps Hold 120-60	Amps Inrush 120-60	Watts DC	Ship Wt. Lbs.	Dimensions In Inches			
								A	B	C	D
1/2	90	14W22	25	0.4	1.2	18	7	7	5-7/8	2-7/8	3-1/4
	140	114W42	40	0.6	1.8	28		7	5-7/8	2-7/8	
	180	129W42	65	1.2	3.6	33		10	8	6-7/8	
3/4	50	14W23	25	0.4	1.3	18	8	7-1/8	6	2-7/8	3-1/2
	110	114W43	40	0.6	2.0	28		7-1/8	6	2-7/8	
	180	129W43	65	1.2	3.9	33		11	8-1/8	7	
1	25	16W14	25	0.4	1.5	18	10	8	6-5/8	3-1/4	4-1/8
	50	116W24	40	0.6	2.3	28					
	90	116W44	40	0.6	2.3	28					
	180	131W44	65	1.2	4.2	33					
1-1/2	25	35W16	45	0.8	3.2	23	17	10	8-1/8	4	4-7/8
	50	35W26	45	0.8	3.2	23					
	90	135W46	65	1.2	4.8	33					
	180	141W46	85	2.0	10.0	45					
2	25	36W17	45	0.8	3.5	23	27	11	8-3/4	5-3/8	6
	50	36W27	45	0.8	3.5	23					
	115	42W47	60	1.2	7.4	35					
	180	142W47	85	2.0	11.0	45					

Strainers are recommended for use with solenoid valves (See page 19)

**When you order please supply the following:**

- Pipe Size
- Valve Type
- Voltage (AC or DC)
- Hertz
- Fluid
- Fluid Temperature
- Max. Diff. Pressure
- Optional Features

(See pages 24 & 25)

**Face To Face Dimensions for Flanged Ends**

(For complete dimensions, weights and other sizes see Engineering Catalog 3006-ENG)

Pipe Size	Dimension In Inches	
	150# Flanged	300# Flanged
1	6-1/2	7-1/2
1-1/2	6-1/2	7-1/2
2	8	9

# STAINLESS STEEL SOLENOID VALVES

Dependable • Packless



## TYPE "WR" FULL PORT - NORMALLY OPEN 1/2" TO 2" PIPE SIZE

*NO DIFFERENTIAL PRESSURE REQUIRED TO OPEN*

**OPERATION:**

Valve closes when energized and opens when de-energized. When the coil is energized the plunger presses the poppet, closing the pilot orifice, and opens a bleed passageway to permit pressure to build above the piston and seat it. Upon de-energizing the coil, the pilot orifice is opened, relieving the pressure above the piston allowing it to leave its seat. The bottom spring allows the valve to operate at zero pressure drop.

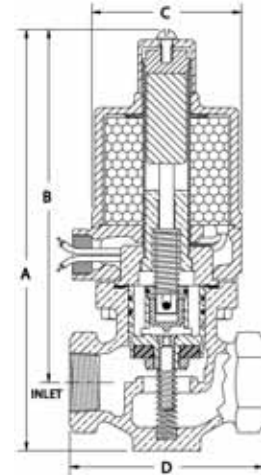

**CONSTRUCTION:**

(\*Wetted parts - No Copper Bearing Alloys in contact with fluid)

\*Valve Body - 304 Stainless Steel Globe Pattern - NPT ends

**(For Flanged Ends see Options page 24)**

\*Piston - 303 Stainless Steel

Coil Enclosure - Malleable or Cast Iron, 1/2" NPS conduit conn.

\*Plunger - 430 Stainless Steel

\*Poppet - 303 Stainless Steel

\*Stem - 303 Stainless Steel

\*Bonnet Tube - 304 Stainless Steel

\*Spring - Inconel

\*Body Seal - Non Asbestos Gasket

\*Orifice Seal - Glass Filled Teflon

\*AC Shading Coil - Silver

\*Stem Pin - 304 Stainless Steel

Coil - Encapsulated Class H, 18" leads

**MAX. FLUID TEMP.  
400° F**  
**MAX. STATIC PRESSURE  
200 PSI**



**APPLICATION:**

**To control the flow of STEAM.** Steam must be free of sediment. Valve operates from zero to maximum differential pressure indicated in table. Valve must be mounted in horizontal pipe with solenoid enclosure vertical and on top.

**FOR OPTIONS & ACCESSORIES  
SEE PAGES 24 & 25**

Strainers are recommended for use with solenoid valves

(See page 19)

**When you order please supply the following:**

- Pipe Size
- Valve Type
- Voltage (AC or DC)
- Hertz
- Fluid
- Fluid Temperature
- Max. Diff. Pressure
- Optional Features

(See pages 24 & 25)

Pipe Size Inches	Max. Diff. PSI	Type No.	Watts AC	Amps Hold 120-60	Amps Inrush 120-60	Watts DC	Ship Wt. Lbs.	Dimensions In Inches				
								A	B	C	D	
1/2	90	14WR22	25	0.5	1.5	18	7	8-1/8	7	2-7/8	3-1/4	
	140	114WR42	40	0.8	2.4	28		9-1/8	8	3-1/2		
	180	129WR42	65	1.5	4.2	33		10	9-1/8	8		3-1/2
3/4	50	14WR23	25	0.5	1.6	18	8	8-1/4	7-1/8	2-7/8	3-1/2	
	110	114WR43	40	0.8	2.6	28		9-1/4	8-1/8	3-1/2		
	180	129WR43	65	1.5	4.3	33		12	9-1/4	8-1/8		3-1/2
1	25	16WR14	25	0.5	1.8	18	10	9-1/8	7-3/4	3-1/4	4-1/8	
	50	116WR24	40	0.8	2.9	28		10	9-1/8	7-3/4		3-1/4
	90	116WR44	40	0.8	2.9	28		14	10	8-5/8		3-1/2
1-1/2	25	35WR16	45	1.0	3.8	23	18	11-3/8	9-1/2	4	4-7/8	
	50	35WR26	45	1.0	3.8	23		18	11-3/8	9-1/2		4
	90	135WR46	65	1.5	5.7	33		22	11-5/8	9-3/4		4-1/2
2	25	36WR17	45	1.0	4.2	23	27	12-3/8	10-1/8	5-3/8	6	
	50	36WR27	45	1.0	4.2	23		27	12-3/8			10-1/8
	115	42WR47	60	1.7	7.3	35		32	12-5/8			10-3/8
2	180	142WR47	85	3.5	11.0	45	32	12-5/8	10-3/8	5-3/8	6	

Dimension In Inches		
Pipe Size	150# Flanged	300# Flanged
1	6-1/2	7-1/2
1-1/2	6-1/2	7-1/2
2	8	9

**Face To Face Dimensions for Flanged Ends**

(For complete dimensions, weights and other sizes see Engineering Catalog 3006-ENG)





# OPTIONAL FEATURES

For Dependable • Packless Solenoid Valves

See Individual Options For Availability For Use With Specific Valve Types

## BOTTOM MOUNTED OPTIONS Note: Only One Bottom Mount Option Can Be Installed On Each Valve

### MANUAL OVERRIDE

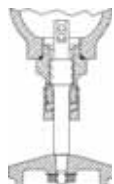

(Normally Closed valves only)  
(Designated by Prefix "MO")  
Enables manual opening of solenoid valve during power failure or to override automatic controls.

### LEVER

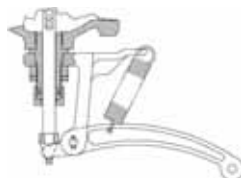

(Normally Closed valves only)  
(Designated by Prefix "LV")  
Enables rapid opening of solenoid valve. Can be chain operated for use at inaccessible locations.

### DASHPOT



(Designated by Prefix "DP")  
Furnished for clean liquids to reduce water hammer effect sometimes encountered in long pipe runs by slowing valve closing.

### FLOW CONTROL

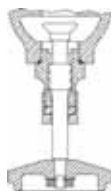

(Normally Closed, NR & MR valves, only)  
(Designated by Prefix "FC")  
Provides a manual method of reducing or throttling the flow.

### MOUNTING STUD



(Designated by Prefix "MS")  
3/8"-16 thread can be furnished in bottom of body to facilitate mounting on bracket. (Not available on 2", 2-1/2" and 3")

### DRAIN



(Normally Closed, NR & MR valves, only)  
(Designated by Prefix "DR") - 1/4" NPT plug supplied in bottom of valve to facilitate draining of liquid from valve body.

## OTHER OPTIONS

### PILOT TAP



(Designated by Prefix "PT")  
Type D, G & GR Valves can be furnished with 1/8" tapped hole for pilot connection or pressure gauge.

### DIN CONNECTOR

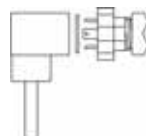

(Designated by Suffix "DN")  
Provides 3 prong connector for easy power connect / disconnect.

### "HUM FREE": (No AC Hum/Buzz)

(Designated by Suffix "HF") - The "HUM FREE" option eliminates the "AC hum" associated with AC operated solenoid valves. Enables valves to be used where an AC hum would not be acceptable and AC is the only power source available. IE: Hospitals, labs, schools (class rooms), homes, office environments etc. & when 24 vac is required for 40 series valves.

### Leak / Dead Tight:

(Normally Closed valves only)  
(designated by Prefix "LT") - The Leak / Dead Tight Option is used to satisfy a Class VI tight shutoff requirement. This option offers 'soft' resilient seating or 'gapless' seal. Consult Factory for Max. Diff. Pressure and Valve Type availability.

### Flanged Ends for SS Valves:

(Designated by Suffix "F1" for 150 lb or "F3" for 300 lb Flanges) Available on stainless steel valves. (Flanged ends for bronze valves available through our Clark-Cooper Division, see bottom of page 3).

### Explosion-Proof and Watertight Solenoids:

(Designated by Prefix "F") - are Explosion-proof and NEMA 4, 7C & D, 9E, F & G suitable for use in hazardous locations requiring Class I, Groups C & D & Class II Groups E, F, and G equipment.

### NEMA 4X:

(Designated by Prefix "F" AND Suffix "ZP") - are suitable for use in locations requiring a NEMA 4X designation. "ZP" (Zinc Plating) replaces the standard paint used on the Coil housing (cup and base). The additional corrosion protection satisfies NEMA 4X requirements. Internal construction, pressure ratings, power consumption, and external dimensions are the same as for standard valves.

### Nickel Plating:

(Designated by Suffix "NP") - Plating is 0.0005" Thick Meets Mil Spec. C26074

**Universal Mount Valves For Mounting In Vertical Pipe Runs**  
(See Magnatrol Universal Mount Catalog 3006-UM)

# POSITION INDICATORS

## For Normally Closed Solenoid Valves



**FEATURES:**

- Packless non-wetted enclosed operation
- Colored magnet shows valve-open position
- Clear high-strength polycarbonate housings
- Heavy-duty Normally Open Reed Switch (PS)
- Wide operating temperature range
- Teflon Housing for temperatures up to 400°F & Cryogenics \*\*
- Explosion-Proof Housing available for hazardous areas \*\*

**“PD” (POSITION DISPLAY) - VISUAL INDICATION ONLY**

**CONSTRUCTION:**

- Housing: Clear High-Strength Polycarbonate

**APPLICATION:**

- Visual Indication that valve is Open / Closed

**OPERATION:**

When the valve is in the closed position, a ferromagnetic “target” attached to the valve’s piston, lifts a green colored magnet into the adapter hiding it from view. When the valve is energized, (open position), the magnet drops down to a visible position.

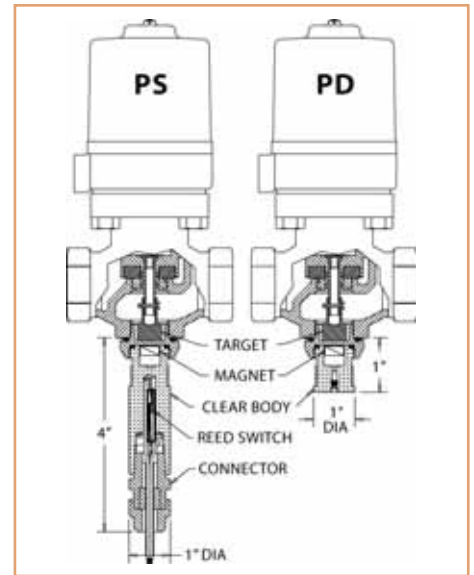

**Position Indicators for Normally Closed Valve Only\* Available on Type A, S, L, K, W & G Valves**

**NOTE: ONLY ONE BOTTOM MOUNTED OPTION CAN BE INSTALLED ON EACH VALVE\***

**“PS” (POSITION SWITCH) - VISUAL INDICATION WITH SWITCH\*\***

**CONSTRUCTION:**

- Housing: Clear High-Strength Polycarbonate\*\*

**APPLICATION:**

- Visual Indication that valve is Open/Closed and Contact Closure (Switch)\*\*

\*\* (See alternate housing(s) below for High Temperature, Cryogenic and Explosion-Proof applications)

**OPERATION:**

When the valve is in the closed position, a ferromagnetic “target” attached to the valve’s piston, lifts a green colored magnet into the adapter hiding it from view. (The reed switch is in its normally open contact position). When the valve is energized, (open position), the magnet drops down to a visible position and closes the magnetically operated reed switch contacts. The reed switch is capable of switching both AC and DC, permitting direct control over a wide range, from low-level load to electromagnetic power load. It has a rated operational current 240 VAC 0.5 A, 115 VDC 0.3A and a minimum operational power of 24V 1mA. The switch is wired with 22 AWG conductors exiting through a liquid tight strain relief connector.

**To indicate Option when Ordering:**

Use Prefix “PD” for Position Display  
Use Prefix “PS” for Position Switch

**Example PS18A44** indicates a Position Switch mounted on a type 18A44 valve.

**\*For multiple switches and where a switch and a bottom mounted option are required, contact our Clark Cooper Div. (See bottom of Page 3).**

**\*\* ENCLOSURES & TEMPERATURE RATINGS**

Indicator Housings	Option	Application		Fluid Temperatures	Visual Indication
		Expl. Proof	NEMA 4 & 4X		
Clear High-Strength Polycarbonate	PD	Yes	Yes	-40°F To 280°F (137°C)	Yes
	PS	No			
Teflon Housing	PS	No	Yes	Up To 400°F (204°C) and Cryogenics	No
Explosion Proof Housing	PS	Yes	Yes	Up To 400°F (204°C) and Cryogenics	No

**MAGNATROL VALVE CORPORATION**



# REQUEST A QUOTE

Fill In The Information Below

If you have any questions or wish to request a quote:  
**Phone: 973-427-4341 • Fax: 973-427-7611**  
**E-Mail: info@magnatrol.com**

## We appreciate the opportunity to quote on your requirements.

**For immediate quote** – Fill in the information below and CALL: 973-427-4341

**For same day quote** – Fill in the information below and FAX: 973-427-7611

**For quote within 24 hrs** – Go online to [www.magnatrol.com](http://www.magnatrol.com), and go to Quick Quote.

## YOUR COMPANY DATA

**Company Name:** \_\_\_\_\_ **Phone:** \_\_\_\_\_  
**Contact (Your Name):** \_\_\_\_\_ **Fax:** \_\_\_\_\_  
**Your RFQ Reference (If Any):** \_\_\_\_\_  
**Type of Business:**  OEM  Re-Seller  Consumer/End User  
**E-Mail:** \_\_\_\_\_

## VALVE DATA

**Desired Delivery:** \_\_\_\_\_  
**Your Reference (Optional):** \_\_\_\_\_  
**Quantity:** \_\_\_\_\_  
**Valve Construction Material:**  Bronze or  Stainless Steel  
**Pipe Size:** (1/4" thru 3"): \_\_\_\_\_  
**Normally:**  **Closed** (Energize To Open) or  **Open** (Energize To Close)  
**Voltage:**  **AC:** \_\_\_\_\_ Volts/\_\_\_\_\_ Hz or  **DC:** \_\_\_\_\_ Volts  
**Maximum Differential Pressure:** \_\_\_\_\_ PSI  
**Maximum Fluid Temperature:** \_\_\_\_\_ °F

### Optional Feature: (See Optional Feature Details On Pages 24 & 25)

Choose One (1) Of The Following Per Valve:  MO  LV  DP  FC  MS  DR  PD  PS

Additional Options:  HF  LT  NP  PT (Can be combined with one (1) of the above Optional Features)

**Enclosure Options:**  General Purpose  Explosion Proof  NEMA 4  NEMA 4X  
**(For Solenoid Housing)** (Standard - NEMA 12) (Prefix "F") (Prefix "F") (Prefix "F" & Suffix "ZP")

**Comments:** \_\_\_\_\_  
\_\_\_\_\_  
\_\_\_\_\_

### Quantity Discounts: Consult Factory

**Delivery: Most orders ship in 7-10 days. Small emergency orders can be shipped in 1-2 days.**

## MAGNATROL VALVE CORPORATION



# ORDERING GUIDELINES

Magnatrol Solenoid Valves



If you have any questions or wish to request a quote:  
**Phone: 973-427-4341 • Fax: 973-427-7611**  
**E-Mail: info@magnatrol.com**

**For Help In Choosing The Correct Valve For Your Application:  
 REFER TO THE VALVE SELECTION CHART ON PAGE 3**

## MAGNATROL VALVE TYPE NUMBERS PREFIX AND SUFFIX BREAKDOWN

*For Additional Information On Options  
 See Optional Features Pages 24 & 25*

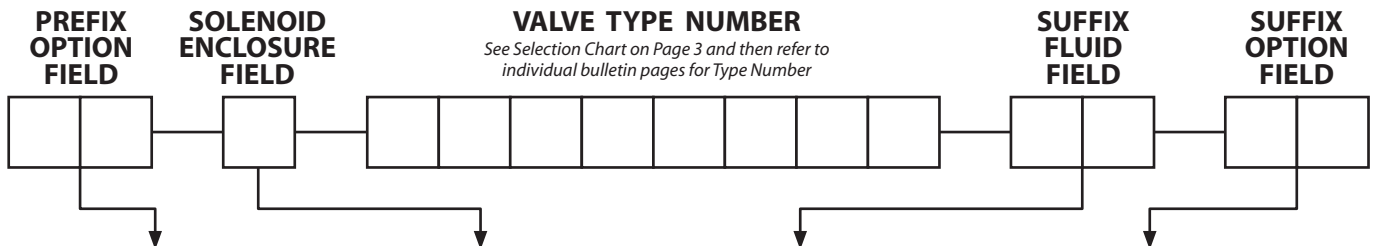

- Prefix Letters for Options:**  
 Choose One
- DP** ..... Dashpot (Consult factory for valve type availability)
  - DR** ..... Drain Plug \*\*
  - FC** ..... Flow Control \*\*
  - LV** ..... Lever \*
  - MO** ..... Manual Override
  - MS** ..... Mounting Stud
  - PD** ..... Position Display \*
  - PS** ..... Position Switch \*
  - PT** ..... Pilot Tap \*\*\*

- Prefix Letters for Solenoid Enclosures:**
- (Blank)** = NEMA 12
  - F** = Explosion Proof & NEMA 4
  - F with ZP Suffix** = NEMA 4X

- Suffix Letters for Fluids: †**
- A** ..... Air
  - B** ..... Brine
  - C** ..... Gritty Coolant
  - G** ..... Gas
  - H** ..... Hot Water
  - J** ..... Jet Fuel or Kerosene
  - K** ..... Gasoline or Naphtha
  - L** ..... Alcohol
  - O** ..... Oil
  - P** ..... Soluble Oil or Coolant
  - R** ..... Freon/Refrigerant
  - V** ..... Sandy Well Water
  - W** ..... Cold Water
  - Y** ..... Gaseous Oxygen
  - YZ** ..... Liquid Oxygen
  - Z** ..... Cryogenics

- Suffix Letters for Options:**
- DN** ..... Din Connector
  - E** ..... Extra Fast Closing
  - HF** ..... Hum Free
  - HT** ..... High Temperature Coil
  - LT** ..... Leak/Dead Tight (Soft Seat Pilot)
  - NP** ..... Nickel Plated (.005 Thickness) Meets Mil Spec C26074
  - X** ..... Sealant
  - ZP** ..... Zink Plated Cup & Base
- For Stainless Valves: ††**
- F1** ..... 150# Flanged Ends
  - F3** ..... 300# Flanged Ends

\* Normally Closed Only  
 \*\* Normally Closed and NR & MR Valves  
 \*\*\* Pilot Tap: Can be used along with any other option. Available for Type D, G and GR only.

† If your fluid is not listed leave blank & advise Magnatrol of fluid

†† For flanged bronze valves contact our Clark-Cooper Div. See bottom of page 3.

**VALVE DISC AND GASKET CHANGES:**

Valve Disc and Gasket are sometimes changed/substituted for better performance with a given fluid. The change is represented by the insertion of a letter after the Valve Type letter(s). The inserted letter represents the substituted Disc/Gasket material. See examples below:

**Examples:**

- V - Viton Disc (i.e. Type 18A44 with Viton Seals becomes 18AV44)
- T - Teflon Disc (i.e. Type 18A44 with Teflon Seals becomes 18AT44)
- B - Buna-N Disc (i.e. Type 16L44 with Buna-N Seals becomes 16LB44)

**NOTE:** Refer to individual bulletins for Valve Type's standard Disc and Gasket materials.

**NOTE**

**Magnatrol Valve Type Numbers DO NOT include Voltage information.**

**VOLTAGE (AC Volts and Hz or DC Volts) MUST BE SPECIFIED when requesting a quote or placing and order.**



## TERMS & CONDITIONS OF SALE

### CONTACT INFORMATION

Solenoid valve questions can be answered quickly and accurately over the phone:

**Phone: 973-427-4341 • Fax: 973-427-7611**

### TERMS & CONDITIONS OF SALE

- 1. Catalog:** This catalog supersedes all previous issues.
  - 2. Quotations:** Quotations are made for acceptance within 60 days and are subject to change or withdrawal without notice.
  - 3. Prices and Discounts:** All prices and discounts are in accordance with the prices and discounts established by Magnatrol and are subject to change without notice.
  - 4. Terms:** Net 30 days, subject to establishment of credit.
  - 5. Shipments:** All shipments are F.O.B. factory, Hawthorne, New Jersey. Our responsibility ends with delivery of merchandise to the transportation company and issuance to us of formal shipping receipt.
  - 6. Minimum Billing:** Minimum billing charge is \$50.00 net.
  - 7. Cancellations:** Orders are subject to cancellation only with our consent.
  - 8. Shipping Date:** There shall be no liability for default or delay in shipping. All orders, contracts, and agreements are made subject to delays contingent upon accidents, strikes, embargoes or other causes beyond our control.
  - 9. Design and Materials:** All materials and designs are subject to change without notice.
  - 10. Weights and Dimensions:** Weights and dimensions listed in this catalog are as close to actual as is practical but are not guaranteed and are subject to change without notice.
  - 11. Errors:** All clerical errors are subject to correction.
  - 12. Returns for Repair:** Valves returned for repair must be shipped prepaid and accompanied by a detailed report regarding service application, installation and nature of trouble or malfunction.
  - 13. Returns for Credit:** Returns for credit will be accepted only with our consent. Credit will be subject to restocking charge and any additional expenses incurred in restoring valves to saleable condition. Credit will be issued only to original purchaser.
  - 14. Taxes:** Any manufacturer's excise tax, use tax, sales tax or tax or duty of any nature shall be paid by the buyer. In the event that the seller is required to pay any such taxes or duties, the buyer shall reimburse seller therefore. The buyer may provide seller with an exemption certificate or other documents acceptable to taxing or customs authorities at the time an order is placed.
  - 15. Guarantee:** MAGNATROL valves are guaranteed to be free from any defects in material and workmanship for one year or 500,000 cycles, whichever comes first. Our guarantee solely conveys the right to repair or replace free of charge, any defective valves, or parts, thereof, returned to us transportation charges prepaid, within one year after date of original shipment from factory.
- This guarantee shall not apply if the valve has been:**
- Improperly Installed
  - Used for other than intended service
  - Repaired without authorization



Check individual bulletins for listed valves

### MAGNATROL CONTACT INFORMATION

**Sales/Service:** Phone: 973-427-4341  
Fax: 973-427-7611  
Email: info@magnatrol.com

**Mailing Address:** PO Box 17  
Hawthorne, NJ 07507

**Shipping Address:** 21 Horton Avenue  
Hawthorne, NJ 07506

**Administrative:** 67 Fifth Avenue  
Hawthorne, NJ 07506

