



SHENZHEN GRAIGAR MACHINERY CO.,LTD.

Xinfu Building,Center Road,Shajing Street,Baoan District,Shenzhen CN

Tel: +86 755 27541660

Fax:0086-755-23728063

Email:sales@graigar.com

Http://www.gensetspart.com

HGM160/160HC

Automatic Generator Control Module

User Manual



Smartgen Technology

CONTENTS

1 SUMMARY	4
2 PERFORMANCE AND CHARACTERISTICS	4
3 SPECIFICATION.....	4
4 PANEL OPERATION	5
4.1 Keys and Icons.....	5
4.2 Descriptions of Working Modes	6
5 ALARM AND PROTECTION.....	6
6 CONNECTIONS.....	7
7 COMMISSIONING	7
8 TYPICAL APPLICATION.....	8
9 CASE DIMENSIONS (Panel Cutout 78 mm*66mm)	9
9.1 Battery Voltage Input.....	9
9.2 Output and Expansion Relay	9
9.3 Withstand Voltage Test.....	9
10 FAULT FINDING	9
11 HGM170RE RELAY EXPANSION MODULE	10
12 TYPICAL WIRING DIAGRAM.....	11
13 OVERALL DEMENIONS OF HGM170RE	11

1 SUMMARY

HGM160/160HC is an engine control module designed to start and stop the engine via a key switch and pushbuttons on the front panel. When detecting faults (low oil pressure, high water/cylinder temperature, auxiliary alarm, over speed), it will disconnect fuel relay and energize to stop. LED annunciator displays the faults, which can offer real and effective alarm information.

HGM160HC adds hours counter based on HGM160, other functions are as the same.

2 PERFORMANCE AND CHARACTERISTICS

- ◆ Wide range of DC supply;
- ◆ With low oil pressure, high water/cylinder temperature, over speed protection and indication;
- ◆ With charge failure warning;
- ◆ An auxiliary shutdown alarm signal;
- ◆ Speed signal comes from generator frequency;
- ◆ LED displays various alarm states;
- ◆ Built-in dial switch to select frequency 50Hz 60Hz (See the picture).
- ◆ With ETS function;
- ◆ Modular structure design, ABS plastic case, plug-in installation, compact structure with small volume, advanced SCU control, stable performance and convenient operation.

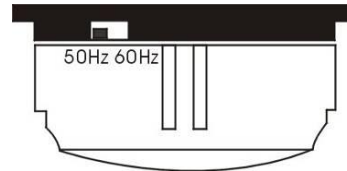

3 SPECIFICATION



Items	Contents
Working Voltage	DC8.0V to 35.0V continuous
Power Consumption	Standby (12V: 0.12W, 24V: 0.24W) Working (12V: 0.5W, 24V: 1W)
Alternator Voltage Input 1P2W	15VAC - 360VAC (ph-N)
Alternator Rated Freq.	50/60Hz
Over Speed Freq.	114% of rated freq.
Condition of Crank Disconnect	Generator voltage \geq 15VAC and frequency \geq 15Hz
Charge Failure Voltage	<3V
3 Digital Inputs	Connect to B- active
Start Output	1Amp DC28V relay output (GND)
Preheat Output	1Amp DC28V relay output (GND)
Fuel Output	1Amp DC28V relay output (GND)
Stop Output	1Amp DC28V relay output (GND)
Hours Counter	Max 99999.9 hours

Items	Contents
Case Dimensions	84mm x72mm x 35mm
Panel Cutout	78mm x 66mm
Operation Condition	Temperature: (-30~+70)°C Humidity: (20~90)%
Storage Condition	Temperature: (-40~+80)°C
Protection Level	IP55: when waterproof rubber gasket added between controller and its panel. IP42: when waterproof rubber gasket not added between controller and its panel.
Insulation Intensity	Object: among input/output/power Quote standard: IEC688-1992 Test way: AC1.5kV/1m 3mA leakage current
Weight	0.25kg





4 PANEL OPERATION

4.1 Keys and Icons

➤ keys

	Stop/Reset	Can stop the running genset; Can reset alarm when an alarm occurs; In Stop Mode, pressing this key at least 3s can test panel indicators. (Lamp Test)
	Manual	In Manual Mode, pressing this key can start genset; In Stop Mode, this key is inactive.
	Preheat	In Manual Mode, press this key to output preheat signal; In Manual Mode and Stop Mode, this key is active.

➤ Icons

	High Temperature	When engine stops for high temperature, it illuminates.
	Low Oil Pressure	When engine stops for low oil pressure, it illuminates.
	Over Speed	When engine over speed, it illuminates.
	Charge Failure	When engine failed to charge, it illuminates.
	Common Alarm	When over speed, temperature high, oil pressure low, auxiliary shutdown alarm, and





		fail to start and fail to stop alarms occur, it flashes.
	Hours Counter	Genset accumulated run hours. Max 99999.9 hours.

4.2 Descriptions of Working Modes

◎ Stop Position (○)

- 1) During genset normal running, turn the key to stop position, fuel relay disconnects and is energized to stop.
- 2) When a fault alarm occurs, turn the key to stop position to remove the alarm.
- 3) When genset at rest, turn key to stop position, controller will be in low power consumption standby mode.
- 4) Press stop key  at least 1second, ETS output. Once release this button, ETS output is disconnected.

◎ Manual Position (Ⓜ)

- 5) Turn the key to manual position. Press  key, preheat outputs. After crank disconnect, preheat output is inhibited.
- 6) Turn the key to manual position. Press  key, after fuel outputs 1second, starter is energized to output and engine cranks. When gens frequency is over 15Hz or start key is released, starter is de-energized and crank disconnect.
- 7) If crank disconnect signal is not detected, press stop key  at least 1 second, ETS output. Once release this button, ETS output is disconnected.
- 8) If crank disconnect signal is detected, press stop key  at least 1 second, ETS disconnects after output 30s, or disconnects after genset at rest for 10 seconds.

5 ALARM AND PROTECTION

- Low Oil Pressure: After crank disconnect, detecting begins after delay 10s. Alarm to shutdown.
- High Temperature: After crank disconnect, detecting begins after delay 10s. Alarm to shutdown.
- Over Speed: Detect when crank disconnect. Over speed lasts for 1.5s, alarm to shutdown.
- Charge failure: Detect after start delay 10s. Warn, not shutdown.
- Auxiliary Stop Alarm: Detect in Manual position, do not detect in stop position. Alarm to shutdown.

- Fail to Start: under normal condition, fail to start within 3 times.
- Fail to Stop: Stop signal has initiated for 30s, but genset not stop.
- Common Alarm: when over speed, high temperature, low OP, auxiliary stop alarm, fail to start, fail to stop alarm occur, alarm annunciator will illuminate.

When controller sends the alarm, pressing stop key  can reset the alarm.

Note: When charge failure occurs, pressing  will stop the engine.

6 CONNECTIONS

Terminals description

No.	Function	Cable Size	Note
1	DC Power Supply B-	2.5mm ²	Connect to start battery negative.
2	DC Power Supply B+	2.5mm ²	Connect to start battery positive. If more than 30 meter, use 2 wires to parallel. Recommended 20A fuse.
3	Fuel Relay Output	1.5mm ²	Fuel output B-, external connect to fuel relay.
4	Start Relay Output	1.5mm ²	Start output B-, external connect to start relay.
5	Pre-Heat Output	1.5mm ²	Pre-heating output. If engine has fired, pre-heat is disabled.
6	Auxiliary Stop Alarm Input	1.5mm ²	Connect to ground.
7	Charge Detection Input	1.5mm ²	Connect to alternator WL (or D+) terminal. When charge fails, the indicator on the front panel will illuminate. (indication only, not shutdown)
8	OP Detection Input	1.5mm ²	Oil pressure signal input. Active when connect to GND. Enabled after delay 10s.
9	Water/Cylinder Temp Detection Input	1.5mm ²	Water/Cylinder temp input. Active when connect to GND. Enabled after delay 10s.
10	Gens L Phase Volt Input	1.5mm ²	External connect to ALT L phase volt output for detecting crank disconnect and speed protection.
11	NC		Not connection
12	Gens Neutral Input	1.5mm ²	External connect to ALT N phase volt output for detecting crank disconnect and speed protection.
13	ETS Output	1.5mm ²	When stop signal is initiated, after outputting 30s or genset at rest, it will disconnect.
14	NC		No connection

7 COMMISSIONING

Please make the under procedures checking before commissioning,

1. Check all the connections are correct and wires diameter is suitable;
2. Ensure that the controller DC power has insurance, controller's positive and negative

- connected to start battery are correct;
3. Auxiliary alarm input is connected to start battery negative via normal close contact of emergency stop button and insurance;
 4. Take proper action to prevent engine to crank disconnect (e. g. Remove the connection wire of fuel valve). If checking is OK, energize start battery;
 5. Set controller into Manual mode, press “start” button, genset will start. After the setting times, controller will send fail to start signal; press “stop” key to reset the controller.
 6. Recover the action of stop engine start (e. g. Connect wire of fuel valve), press start button again, genset will start. If everything goes well, genset will enter into normal running. During this period, please watch for engine’s running situations and AC generator’s voltage and frequency. If abnormal, stop genset running and check all connections according to this manual.
 7. If there are any other questions, please contact Smartgen’s service.

8 TYPICAL APPLICATION

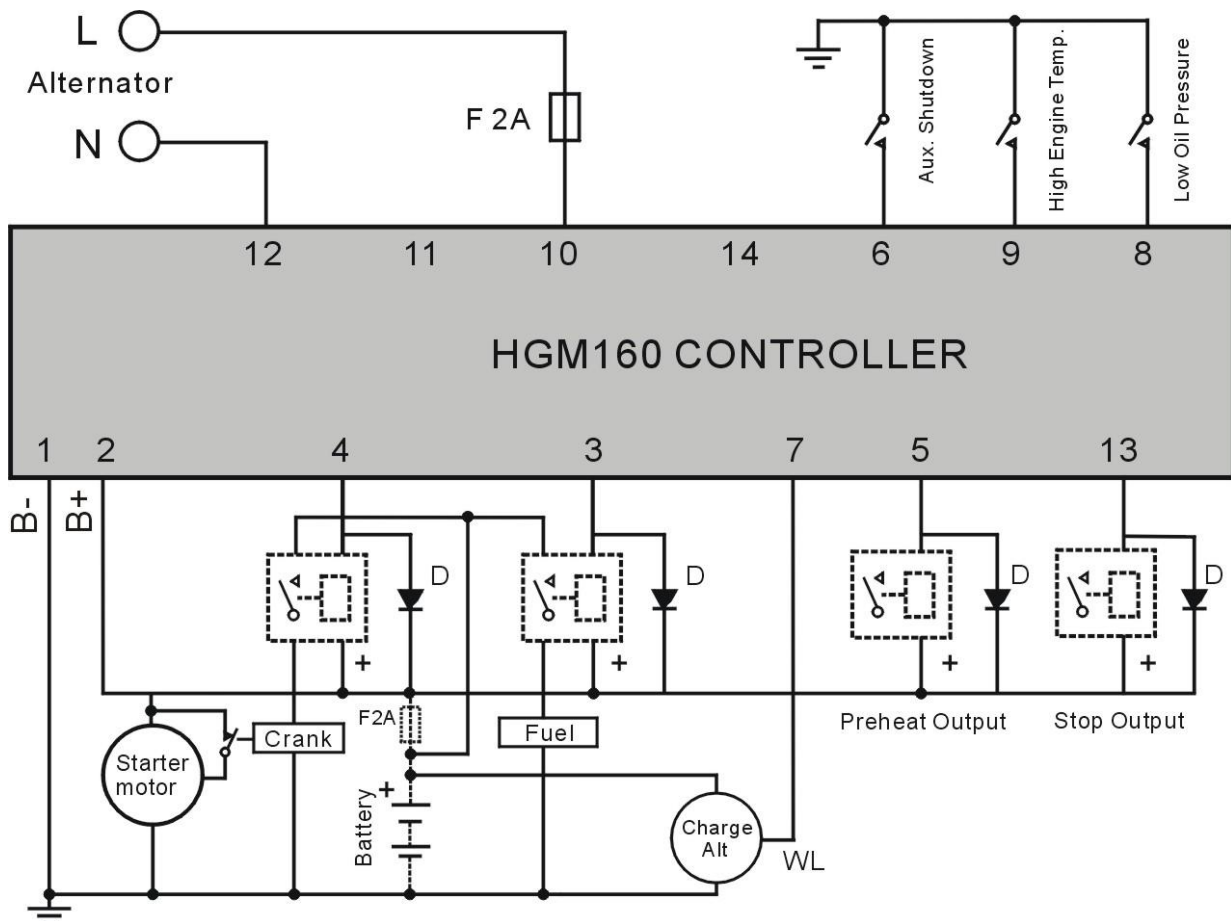

9 CASE DIMENSIONS (Panel Cutout 78 mm*66mm)

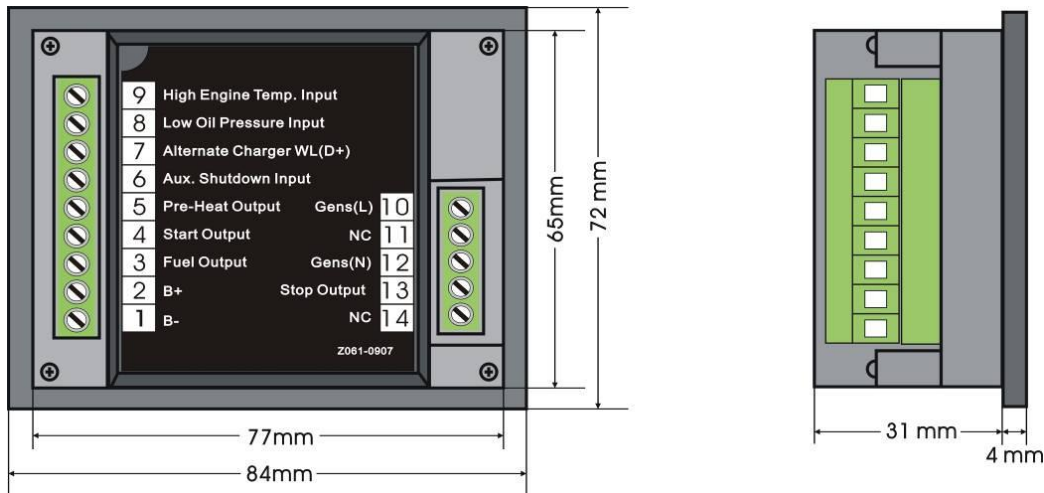

9.1 Battery Voltage Input

HGM160/160HC can be applicable to range of (8-35) VDC battery voltage; battery negative must be reliability connected to engine shell. The connection of controller power supply B + and B- to battery poles should not be less than 2.5mm², if float charger is fitted, please directly connect the charger output wire to battery poles, and then separately connect the wirings from the battery poles to the power supply output of the controller in case that the charger will interfere with the normal operation of the controller.

9.2 Output and Expansion Relay

All output of the controller is relay contacts output, if there is need to expand output relays, please expand follow current diode in both ends of the relay coil (when extended relay coil links DC) or increase resistance and capacitance loop (when extended relay coil links AC) in order to prevent interference with the controller or other equipments.

9.3 Withstand Voltage Test

When the controller has been installed in the control panel, if you want to have withstand voltage test, please disconnect all terminals in the controller lest high voltage damages the controller.

10 FAULT FINDING

Fault	Remedy
Controller no response with power.	Check starting batteries; Check controller connection wirings; Check DC fuse.

Genset shutdown	Check if the engine temperature is too high; Check the genset AC voltage; Check DC fuse.
Low oil pressure alarm after crank disconnect	Check the oil pressure sensor and its connections.
High water/cylinder temp alarm after crank disconnect	Check the temperature sensor and its connections.
Crank not disconnect	Check fuel circuit and its connections; Check starting battery; Check speed sensor and its connections; Refer to engine manual.
Starter no response	Check starter connections; Check starting battery.

11 HGM170RE RELAY EXPANSION MODULE

HGM170RE is modular structure which can be fixed in various guides with compact structure, small size and easy installation.

Expansion circuits output:



1. Fuel relay 30A, output voltage B+, coil power ≤ 0.9W
2. Start relay 30A, output voltage B+, coil power ≤ 0.9W
3. Stop relay 30A, output voltage B+, coil power ≤ 0.9W
4. Auxiliary relay 30A, passive output, coil power ≤ 0.9W

Terminals Description

No.	Items	Description
1	CRANK CTRL	Start relay control, connect to ground.
2	CRANK OUT	Start relay output, B+ output.
3	FUEL CTRL	Fuel control, connect to ground.
4	B+	battery positive
5	B+	Battery negative
6	FUEL OUT	Fuel relay output, B+ output.
7	GND	Battery negative (GND)
8	STOP OUT	Stop relay output, B+ output.
9	AUX CTRL	Auxiliary relay control, connect to ground.
10	AUX OUT1	Auxiliary relay output, free contact normally opens.
11	AUX OUT2	
12	STOP CTRL	Stop relay control, connect to ground.

12 TYPICAL WIRING DIAGRAM

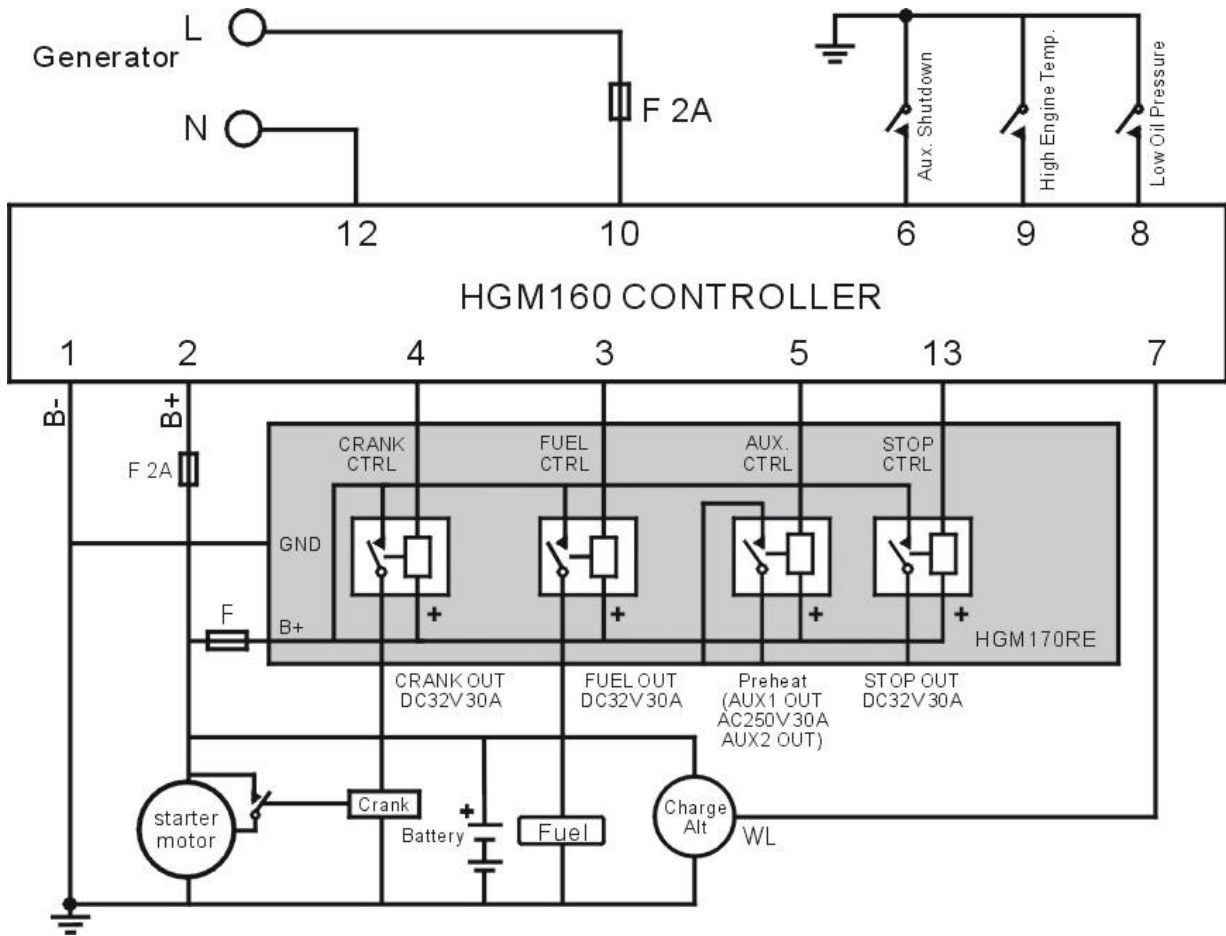

13 OVERALL DEMENIONS OF HGM170RE

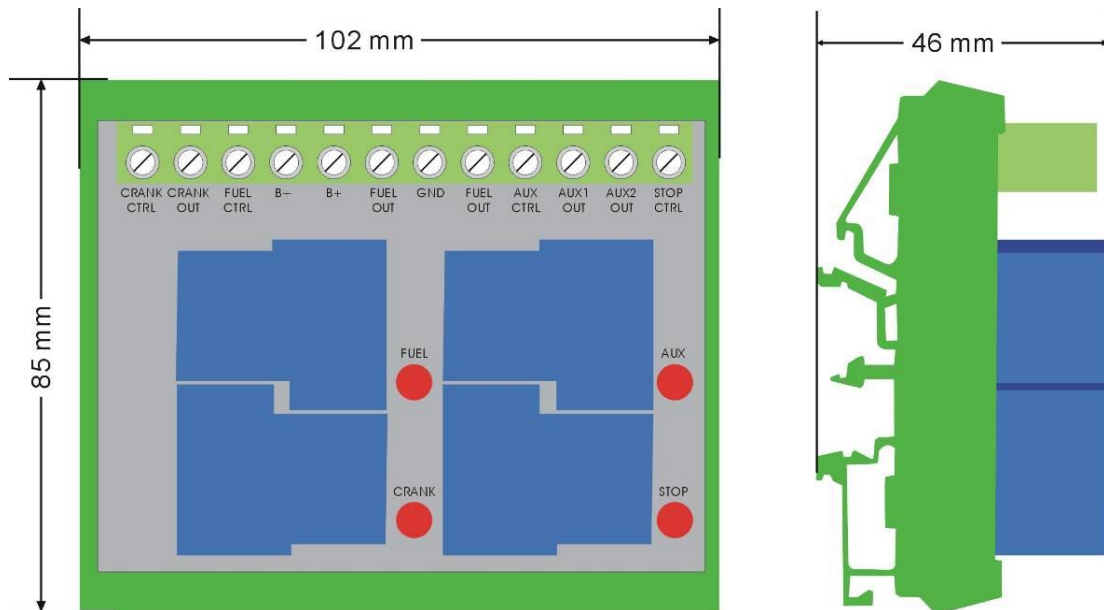

Note: When ordering please specify 12V or 24V.