



Galaxy JA 256/30 AAA

Features:

- 28 picoliter calibrated drop size
- 256 individually addressable, inline nozzles
- Excellent jet straightness
- Excellent channel to channel uniformity
- High frequency continuous operation
- Orientation independent
- Designed for long service life
- Operation up to 90°C (194°F)
- Permits high viscosity jetting fluids
- Dual ported for ease of flushing
- Optional temperature control
- Compatible with aqueous fluids

The Spectra® Galaxy JA 256/30 AAA is a high performance, robust and reliable jetting assembly designed for a broad range of industrial and commercial printing applications such as wide format graphics, addressing and packaging at resolutions up to 900 dpi.

The Galaxy JA 256/30 AAA is a compact ink jet jetting assembly designed specifically for applications requiring multiple printheads packed tightly together. General compatibility with a wide range of fluids makes the Galaxy JA 256/30 AAA highly versatile.

Four electrically independent piezoelectric slices, each with 64 addressable channels, are combined to provide a total of 256 jets. The nozzles are arranged in a single line, at a native 0.010 inch distance between nozzles.

The fluid interface and electrical connection are at the top of the jetting assembly and several mounting configurations are possible. This arrangement permits extremely tight packing in the print process direction. The dual ported fluid interface facilitates flushing for quick change-overs and for displacing drying fluids with inert fluids during periods of non-use.

This jetting assembly contains serial-to-parallel converters for selecting which jets to fire; all jets can be fired simultaneously or individually. By using an optional Head Interface Board, image data can be daisy-chained into one serial stream to reduce the data interface hardware requirements. A high voltage fire pulse with controlled slew rates is used to actuate the pumping chambers within each channel.

Optional temperature control components are available for precise control of fluid viscosity. Optional deaeration hardware can be provided.



www.dimatix.com

SPECTRA®

Parameter	Galaxy JA 256/30 AAA
Number of addressable jets	256
Nozzle spacing	254 microns [0.010 in.]
Nozzle diameter	36 microns
Calibrated drop size	28 picoliters
Adjustment range for drop size	25 - 30 picoliters
Drop size variation, 1 sigma*	5%
Jet Straightness, 1 sigma*	5 mrad [0.29°]
Nominal drop velocity	8 m/sec
Drop velocity variation, 1 sigma*	5%
Crosstalk, maximum	5%
Operating temperature range	up to 90°C [194°F]
Fluid viscosity range (at jetting temperature)	8 - 20 cP
Compatible jetting fluids	Organic solvents; UV curables, Aqueous
Maximum operating frequency	20 kHz

*at constant frequency

Physical Dimensions

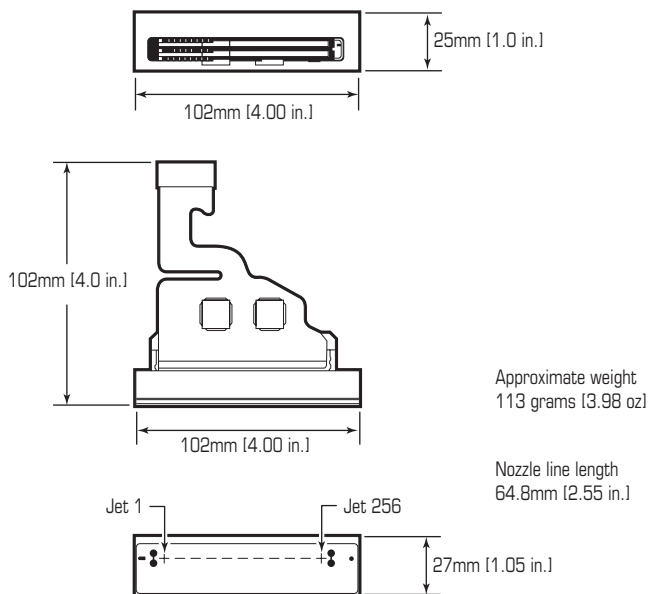

Jetting Characteristics

Galaxy 30 AAA Velocity Frequency Response

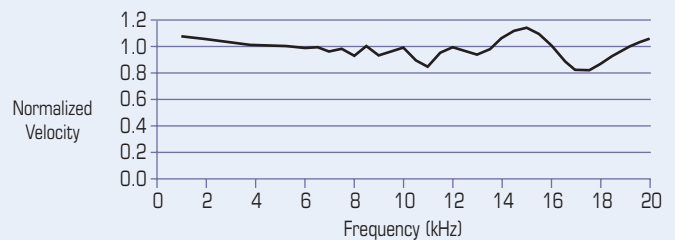

Galaxy 30 AAA Drop Mass Frequency Response

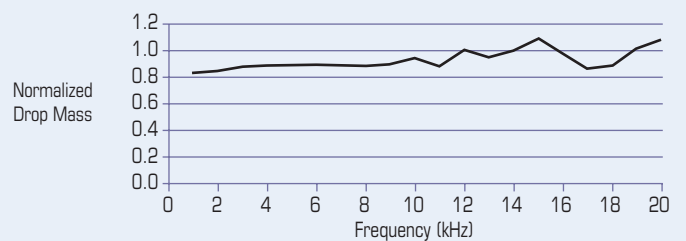

Product data presented above are for guideline purposes only. For design and engineering work using this product, please contact Dimatix Technical Support for the appropriate Product Manual containing full Product Specifications.



Corporate Office:
FUJIFILM Dimatix, Inc.
2230 Martin Avenue
Santa Clara, CA 95050
USA

Tel: (408) 565-9150
Fax: (408) 565-9151
Email: info@dimatix.com

New Hampshire Facility:
FUJIFILM Dimatix, Inc.
109 Etna Road
Lebanon, NH 03766
USA

Tel: (603) 443-5300
Fax: (603) 448-9870
Email: info@dimatix.com

Japan Office:
Advanced Marking Business Division
FUJIFILM Corporation
Midtown West, 7-3, Akasaka 9-Chome
Minato-ku, Tokyo 107-0002
Japan

Tel: +81 3 6271 1091
Fax: +81 3 6271 1165
E-mail: front.ambd@fujifilm.co.jp

European Office:
Tel: +44 7739 863 505
Fax: +44 870 167 4328
Email: euro@dimatix.com

Korean Office:
Tel: +82 2 6242 6012
Fax: +82 2 6247 6012
Email: korea@dimatix.com

China Office:
Email: china@dimatix.com