



In Car Air Purifier and sterilizer



# KAPHOEU

Clean Your Air In Car

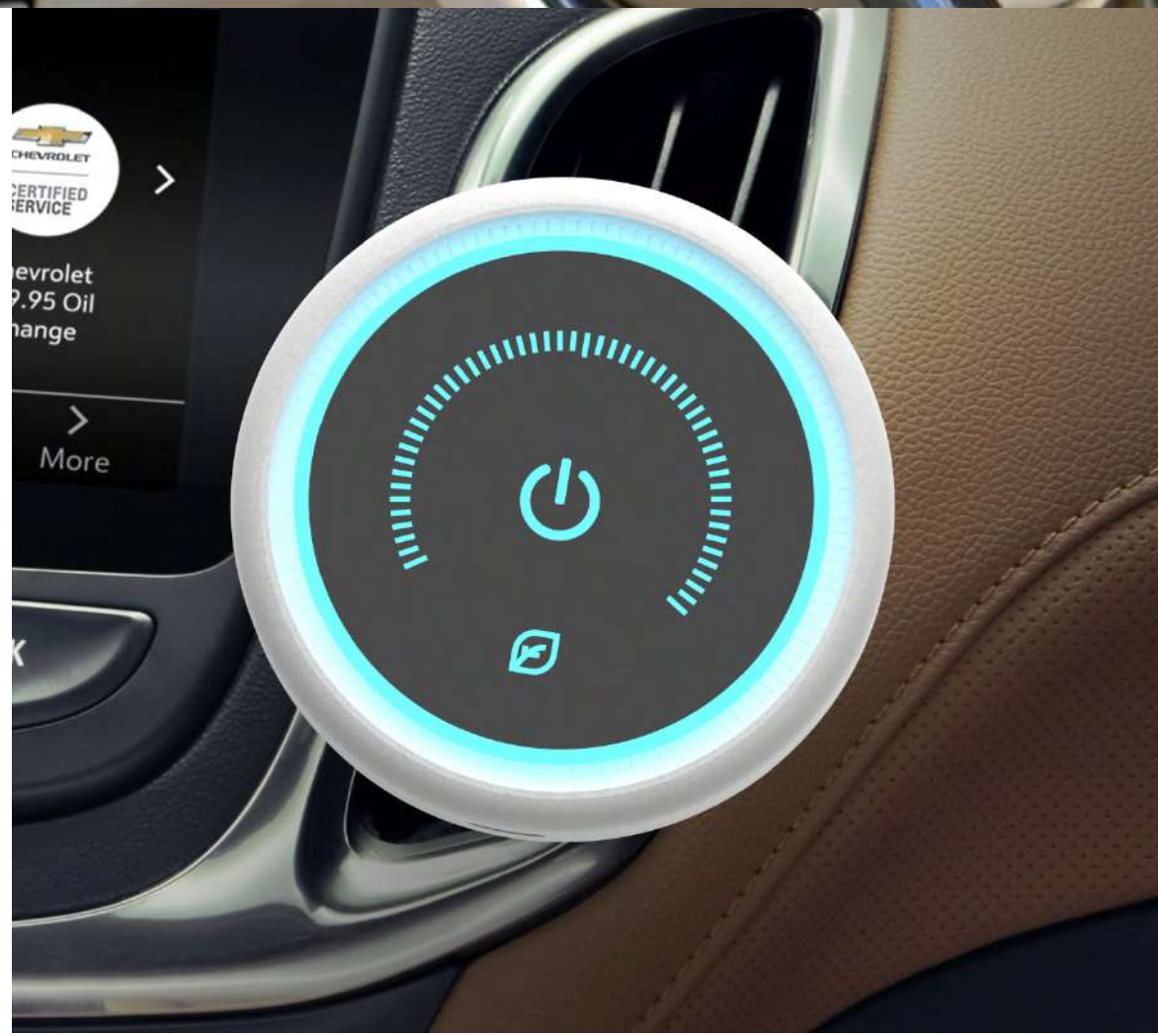





**DEKON**





## Metal based photocatalysis filter

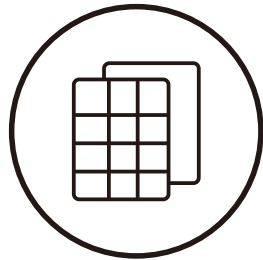

Double Clean

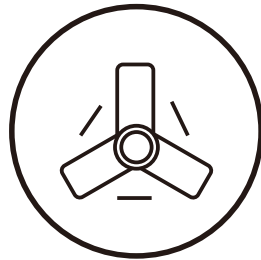

360° Air clean

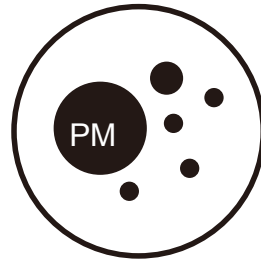

PM2.5 Filter

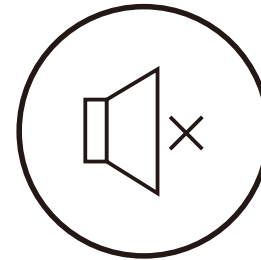

Low Noise

## Effectively remove

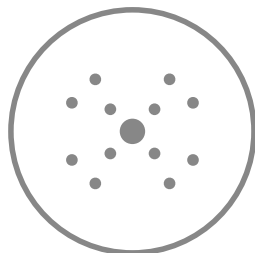

Inhalable  
particle



Toluene  
formaldehyde



Harmful  
gas odor

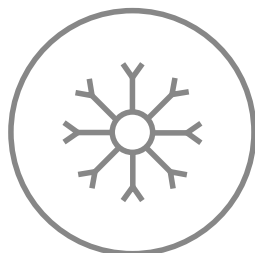

Pollen and  
other allergens

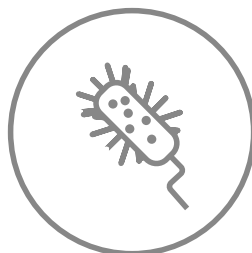

Some bacteria  
germs

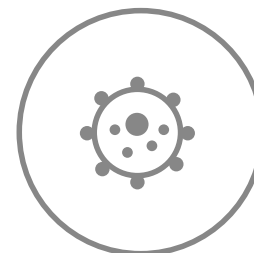

Part of  
the virus

More than 100 types of harmful substances in the car

Toluene, benzene



Bacterial and Virus



P M 2 . 5

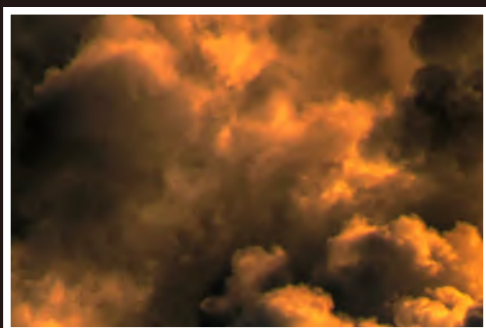

Smells



Invisible damage is coming quietly....



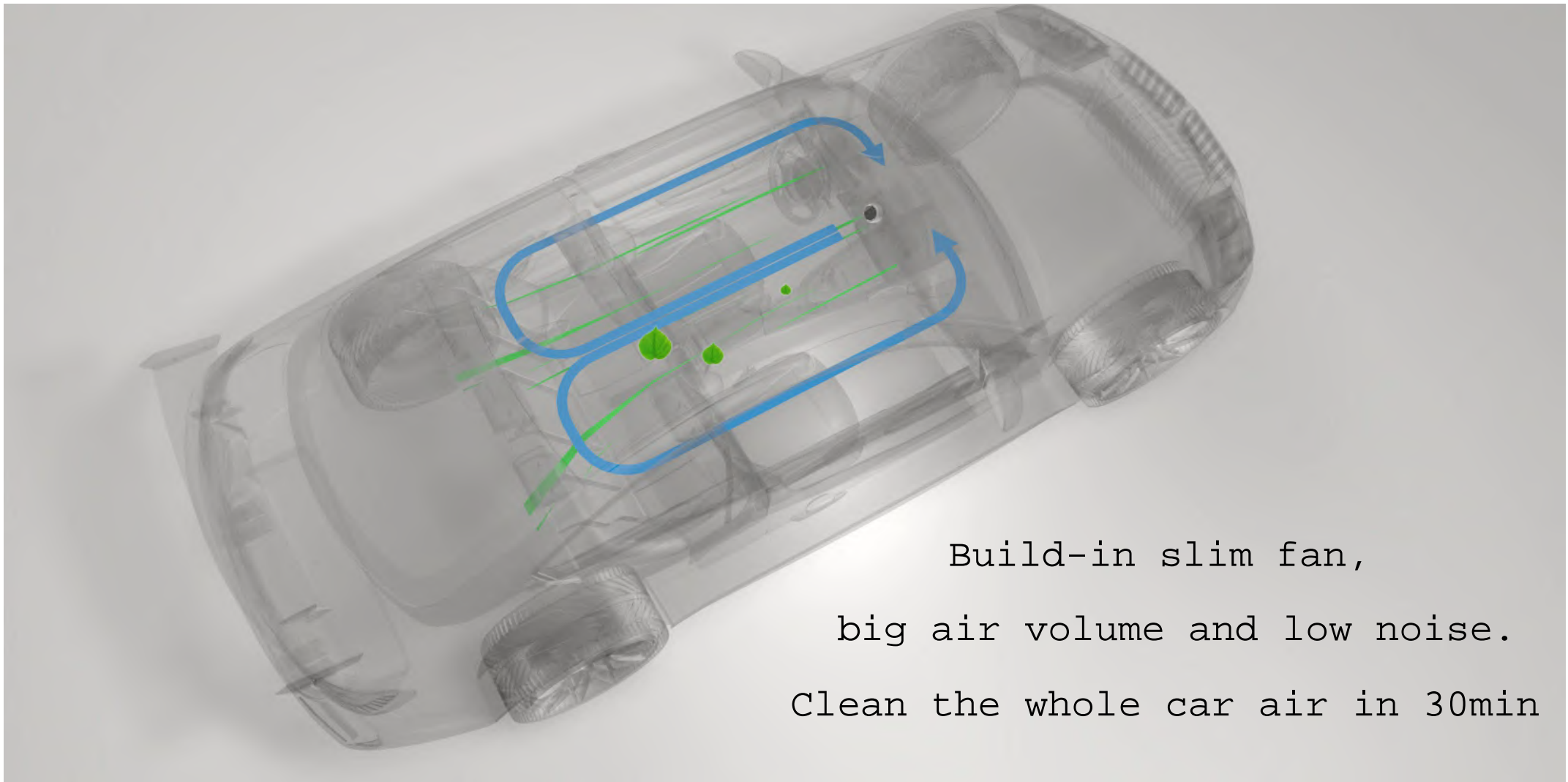

Build-in slim fan,  
big air volume and low noise.  
Clean the whole car air in 30min



**C A D R 15 m<sup>3</sup> / h**  
Clean the PM2.5 Efficiently  
Bring the fresh air in the car

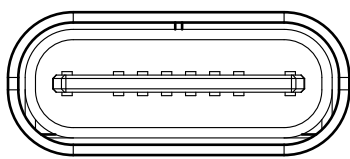

Type-C

## Type-C, 5V

Power supply by USB Cable.

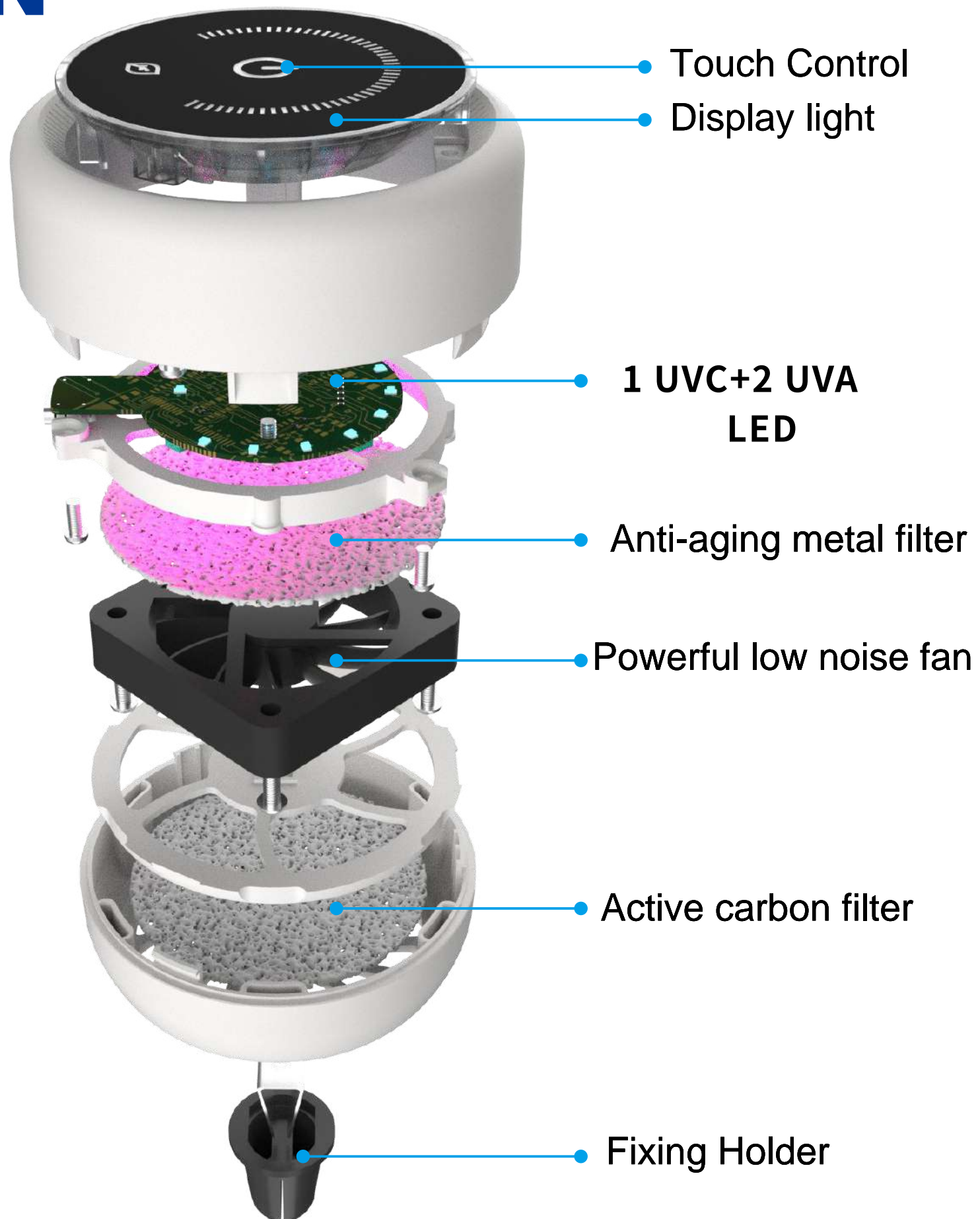





## Display light working concept



White color  
Start to work



Light Blue  
Clean process



Dark Blue  
Clean done



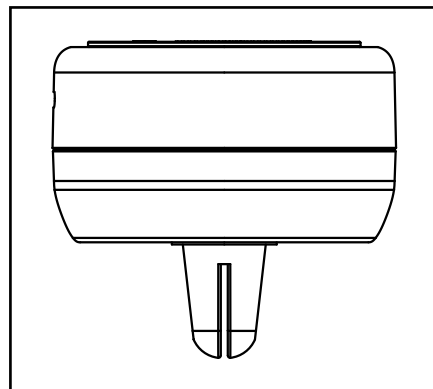

**79x79x73mm**

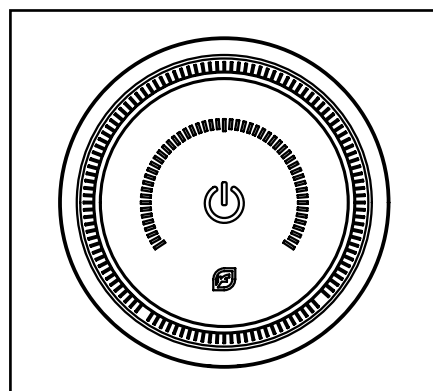

**Touch Control**

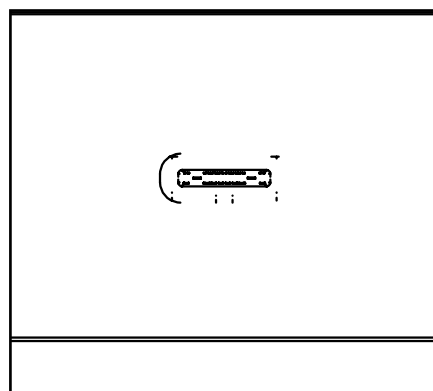

**5V  
TYPE-C**

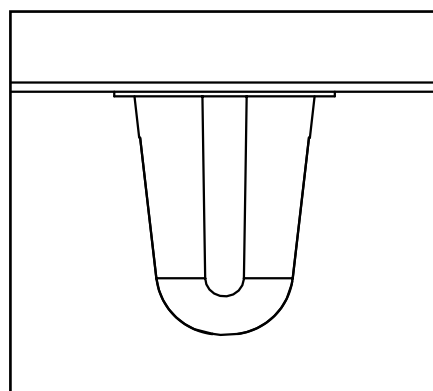

**Fixing holder**



## Detailed dimension drawings

