







160mW 405nm 光纤耦合 卡口激光器规格书

160mW 405nm Specification for fiber coupled laser

产品编码: RH-405-M50-120-K

一、产品参数 Specification

项目 Items	符号 Symbol	典型值 Type	最大 Max	单位 Unit	条件 Condition
工作电流 Working Current	I _{op}	90	120	mA	Po=160mW,TC=25°C
工作电压 Operating Voltage	V _{op}	4.2	5	V	
激光波长 Laser Wavelength	λ _p	405	410	nm	
阈值电流 Threshold current	I _{th}	30	40	mA	
光纤耦合后出光效率 Output Efficiency by Fiber	≥85mW	光纤类型 Type Of Fiber			50/125 NA0.12/0.22 105/125 NA0.22
工作环境温度 Working Temperature	0°C-35°C	光纤接口 Connector Of Fiber			陶瓷插芯卡口 ceramic insert bayonet
储存温度 Storage Temperature	-40°C至 85°C				
尺寸 Size	10*10*20mm	质保期 Warranty period			1 年 One year
接线端子 Terminal block	A  	B  	C  	D 	
电线长度	20cm	40cm	80cm	其他长度	

使用注意事项:

为了防止浪涌, 电路上在激光器管脚正负极之间需要接有一个 3K 电阻;

使用恒流电源, 工作时避免浪涌, 电压在 4.5-5V 之间; 电路设计应有: 缓启动、防浪涌、防过压保护、防过流保

本产品阈值电流 30mA，工作电流 90mA，需要良好的散热。请确认产品半导体制冷板有良好的接触。建议使用 TEC 控温

4、如果客户需要焊接激光器，请操作者务必要带防静电手环，并将电烙铁断电后，方能焊接。防止人体静电、电路浪涌对管芯的冲击

二、产品结构 Structure chart

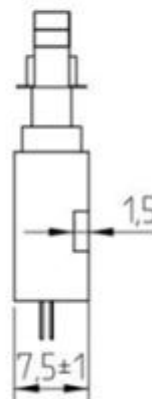
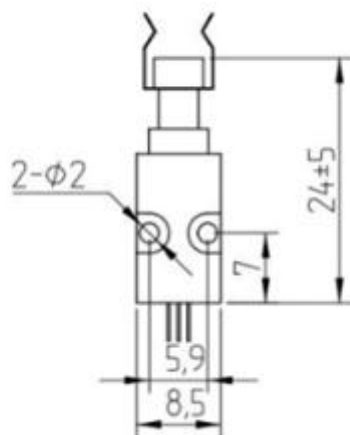
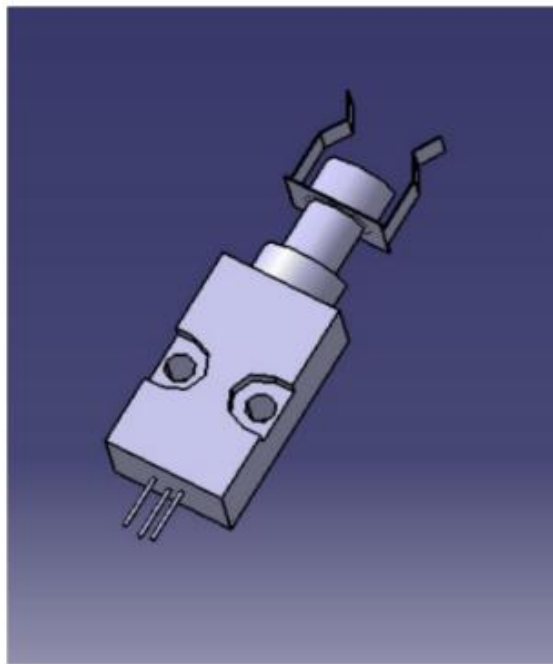

管脚极性图





注意事项

CAUTIONS

1. 激光模块发射的激光有可能对眼睛造成伤害。激光模组工作时，严禁直接注视其端面，并佩戴防护眼镜。

The laser emitted by the laser module is likely to injure eye, so do not directly gaze its end surface and wear appropriate safety glasses to prevent laser when it is working.

2. 激光模块需要带过冲保护、软启动的恒流源，良好的恒流源会减少电流冲击而造成的损坏器件。

The laser module needs a constant current power supply with overshoot protection and soft start function. A good power supply can reduce the damage caused by current shock.

3. 激光模块应当存放或工作于干燥环境，防尘等级达到百万级，已免镜片落入灰尘影响光斑。

Keep the laser module working or storing in a dry environment. The anti-dust grade is over one million, in order to prevent dust inside the lens to affect the laser dot shape.

4. 连续工作中激光管温度不能超过 30℃，如在较高温度下工作，会严重缩短激光模块的寿命，所以本产品需配合 TEC 制冷使用，建议 TEC 温度设为 20℃。

In continuous operation, the temperature of laser diode shall not exceed 30 °C. If the laser diode is operated at a higher temperature, the service life of laser module will be seriously shortened. Therefore, this product needs to be used in conjunction with TEC refrigeration. It is recommended to set the TEC temperature to 20 °C.

5. 输出功率高于指定参数工作，会严重缩短激光模块的寿命。

When output power is higher than it's specific parameter of operation, the life of the laser module will be greatly shortened..

6. 本产品属于静电敏感器件，在人体有良好接地的情况下才可拿取，防静电可采用防静电手镯的方法。

This laser module is an electrostatic sensitive device. Please make sure ground yourself or wear an antistatic wrist strap before you take it.