

# 1.0mm间距直插FFC连接器参数表

1.0A-L-nPF

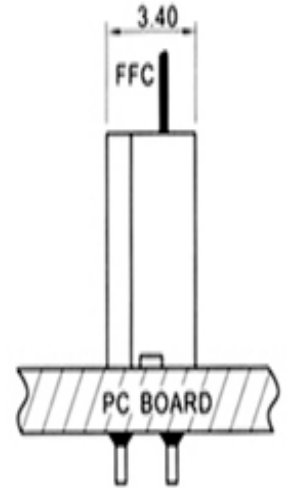

安装图  
ASSEMBLY LAYOUT

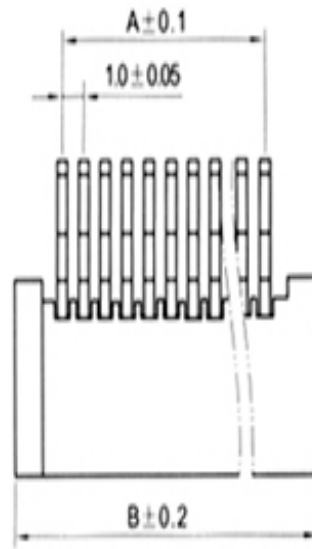
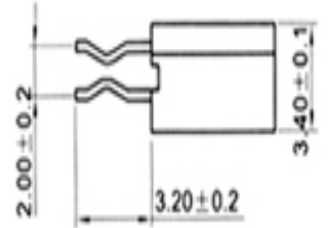
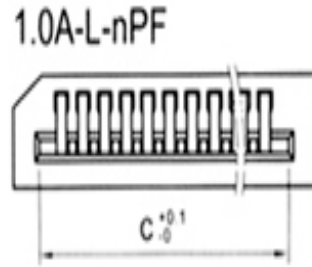
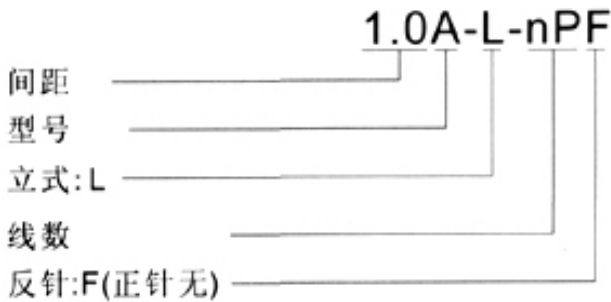
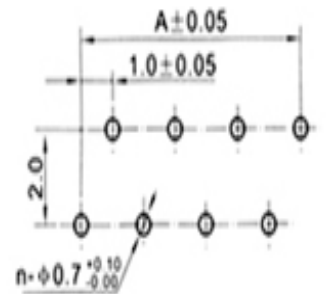

正针 PCB 寸法  
Positive needle PCB LAYOUT

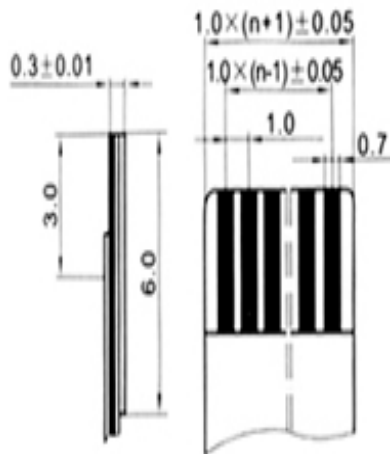

适用扁平电缆  
Proper cable

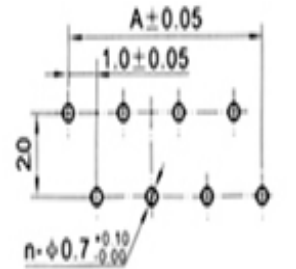

反针 PCB 寸法  
Versa needle PCB LAYOUT

## 接触件

\* 材质：磷青铜

## 塑胶本体

\* 材质：尼龙46，UL94V-0

## 包装方式

- \* 编带包装
- \* 管装
- \* 袋装

## 技术参数

- \* 极数：4 ~ 40
- \* 额定电压：AC、DC、200V（50HZ有效值）
- \* 额定电流：> 0.5A、AC、DC

