

1.0mm间距弯插FFC连接器参数表

1.0A-WS-nPF

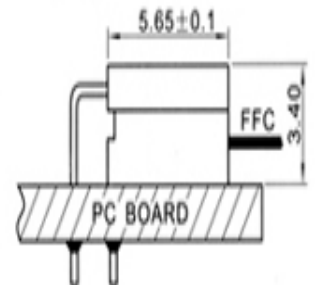
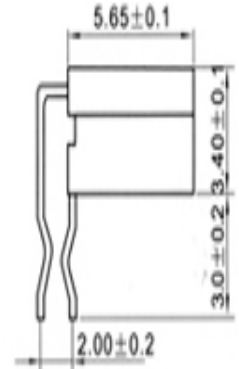
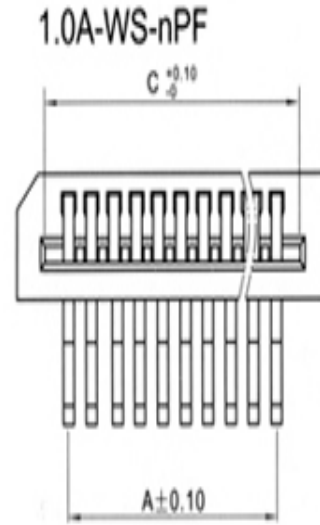
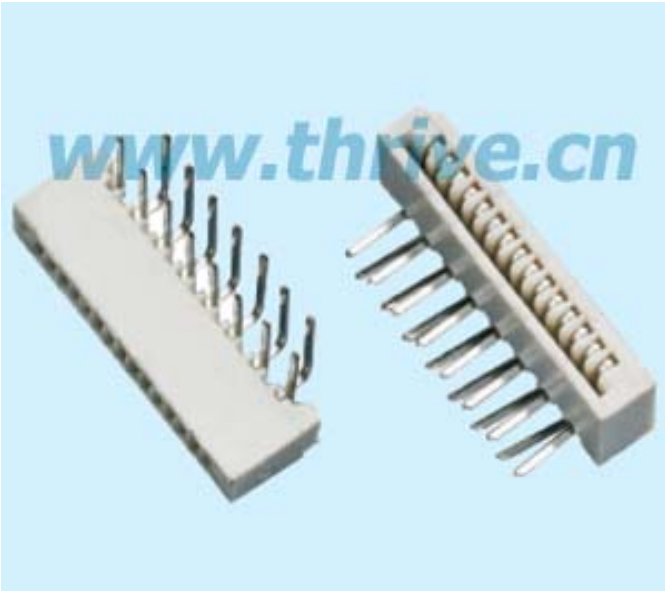

安装图

ASSEMBLY LAYOUT

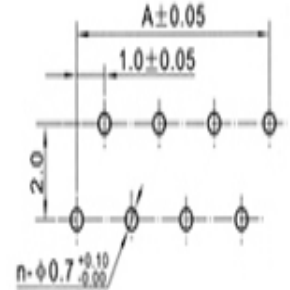
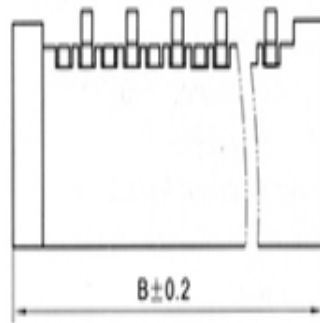

正针 PCB 寸法
Positive needle PCB LAYOUT

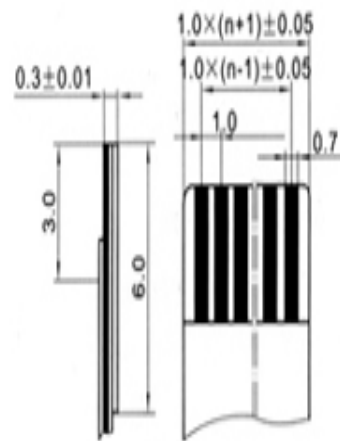

适用扁平电缆
Proper cable

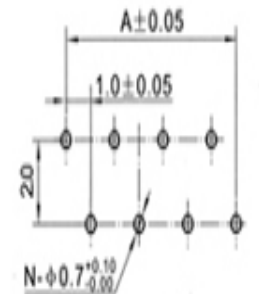

反针 PCB 寸法
Versa needle PCB LAYOUT

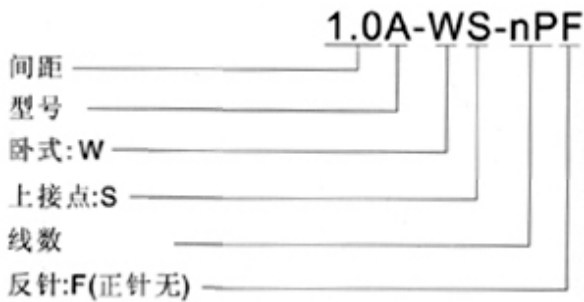

接触件

* 材质: 磷青铜

塑胶本体

* 材质: 尼龙46, UL94V-0

包装方式

- * 编带包装
- * 管装
- * 袋装

技术参数

- * 极数: 4 ~ 40
- * 额定电压: AC、DC、200V (50HZ有效值)
- * 额定电流: > 0.5A 、 AC、DC

