

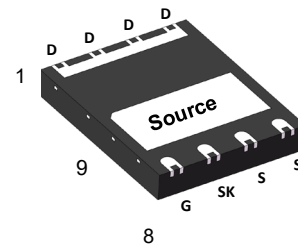
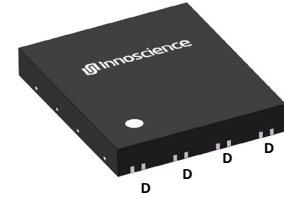
# INN650DA260A

## 1. General description

650V GaN-on-Silicon Enhancement-mode Power Transistor in Dual Flat No-lead package (DFN) with 5 mm × 6 mm size

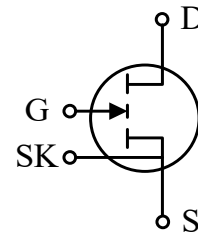
## 2. Features

- Enhancement mode transistor-Normally off power switch
- Ultra high switching frequency
- No reverse-recovery charge
- Low gate charge, low output charge
- Qualified for industrial applications according to JEDEC Standards
- ESD safeguard
- RoHS, Pb-free, REACH-compliant



## 3. Applications

- AC-DC converters
- DC-DC converters
- Totem pole PFC
- Fast battery charging
- High density power conversion
- High efficiency power conversion



## 4. Key performance parameters

Table 1 Key performance parameters at  $T_j = 25\text{ }^\circ\text{C}$

Parameter	Value	Unit
$V_{DS,max}$	650	V
$R_{DS(on),max} @ V_{GS} = 6\text{ V}$	260	m $\Omega$
$Q_{G,typ} @ V_{DS} = 400\text{ V}$	2	nC
$I_{D,pulse}$	22	A
$Q_{OSS} @ V_{DS} = 400\text{ V}$	19	nC
$Q_{rr} @ V_{DS} = 400\text{ V}$	0	nC

## 5. Pin information

Table 2 Pin information

Gate	Drain	Kelvin Source	Source
8	1,2,3,4	7	5,6,9

Table 3 Ordering information

Type/Ordering Code	Package	Product Code
INN650DA260A	DFN 5X6	65DA260A

## Table of contents

1. General description .....	1
2. Features.....	1
3. Applications .....	1
4. Key performance parameters.....	1
5. Pin information.....	1
6. Maximum ratings .....	3
7. Thermal characteristics.....	4
8. Electric characteristics.....	5
9. Electric characteristics diagrams .....	7
10.Package outlines.....	13
11.Reel information.....	14
12.Revision history.....	15

## 6. Maximum ratings

at  $T_j = 25\text{ °C}$  unless otherwise specified.

Continuous application of maximum ratings can deteriorate transistor lifetime. For further information, contact Innoscience sales office.

**Table 4 Maximum ratings**

Parameter	Symbol	Values			Unit	Note/Test Condition
		Min.	Typ.	Max.		
Drain source voltage	$V_{DS,max}$	-	-	650	V	$V_{GS} = 0\text{ V}$ , $T_j = -55\text{ °C to }150\text{ °C}$
Drain source voltage transient <sup>1</sup>	$V_{DS(transient)}$	-	-	800	V	$V_{GS} = 0\text{ V}$ , $V_{DS} = 800\text{ V}$
Drain source voltage, pulsed <sup>2</sup>	$V_{DS,surge}$			750	V	$T_j = 25\text{ °C}$ ; total time < 10h
Drain source voltage, pulsed <sup>2</sup>	$V_{DS,surge}$			750	V	$T_j = 125\text{ °C}$ ; total time < 1h
Continuous current, drain source	$I_D$	-	-	12	A	$T_c = 25\text{ °C}$
Pulsed current, drain source <sup>3</sup>	$I_{D,pulse}$	-	-	22	A	$T_c = 25\text{ °C}$ ; $V_G = 6\text{ V}$ ; See Figure 16;
Pulsed current, drain source <sup>3</sup>	$I_{D,pulse}$	-	-	15	A	$T_c = 125\text{ °C}$ ; $V_G = 6\text{ V}$ ; See Figure 17;
Gate source voltage, continuous <sup>4</sup>	$V_{GS}$	-1.4	-	+7	V	$T_j = -55\text{ °C to }150\text{ °C}$
Gate source voltage, pulsed	$V_{GS,pulse}$	-20	-	+10	V	$T_j = -55\text{ °C to }150\text{ °C}$ ; $t_{PULSE} = 50\text{ ns}$ , $f = 100\text{ kHz}$ open drain
Power dissipation	$P_{tot}$	-	-	75	W	$T_c = 25\text{ °C}$
Operating temperature	$T_j$	-55	-	+150	°C	
Storage temperature	$T_{stg}$	-55	-	+150	°C	

1  $V_{DS(transient)}$  is intended for surge rating during non-repetitive events,  $t_{PULSE} < 200\text{ }\mu\text{s}$

2  $V_{DS,surge}$  is intended for surge rating during repetitive pulse,  $t_{PULSE} < 100\text{ ns}$

3 Pulse = 300  $\mu\text{s}$

4 The minimum  $V_{GS}$  is clamped by ESD protection circuit, as shown in Figure 10

## 7. Thermal characteristics

**Table 5 Thermal characteristics**

Parameter	Symbol	Values			Unit	Note/Test Condition
		Min.	Typ.	Max.		
Thermal resistance, junction-case	$R_{thJC}$	-	-	1.65	°C/W	
Reflow soldering temperature	$T_{sold}$	-	-	260	°C	MSL3

## 8. Electric characteristics

at  $T_j = 25\text{ }^\circ\text{C}$ , unless specified otherwise

**Table 6 Static characteristics**

Parameter	Symbol	Values			Unit	Note/Test Condition
		Min.	Typ.	Max.		
Gate threshold voltage	$V_{GS(th)}$	1.2	1.6	2.2	V	$I_D = 11\text{ mA}; V_{DS} = V_{GS}; T_j = 25\text{ }^\circ\text{C}$
		-	1.9	-		$I_D = 11\text{ mA}; V_{DS} = V_{GS}; T_j = 150\text{ }^\circ\text{C}$
Drain-source leakage current	$I_{DSS}$	-	2	20	$\mu\text{A}$	$V_{DS} = 650\text{ V}; V_{GS} = 0\text{ V}; T_j = 25\text{ }^\circ\text{C}$
		-	10	120		$V_{DS} = 650\text{ V}; V_{GS} = 0\text{ V}; T_j = 150\text{ }^\circ\text{C}$
Gate-source leakage current	$I_{GSS}$	-	40	-	$\mu\text{A}$	$V_{GS} = 6\text{ V}; V_{DS} = 0\text{ V}$
Drain-source on-state resistance	$R_{DS(on)}$	-	165	260	m $\Omega$	$V_{GS} = 6\text{ V}; I_D = 3\text{ A}; T_j = 25\text{ }^\circ\text{C}$
		-	322	-		$V_{GS} = 6\text{ V}; I_D = 3\text{ A}; T_j = 150\text{ }^\circ\text{C}$
Gate resistance	$R_G$	-	2	-	$\Omega$	$f = 5\text{ MHz}; \text{open drain}$

**Table 7 Dynamic characteristics**

Parameter	Symbol	Values			Unit	Note/Test Condition
		Min.	Typ.	Max.		
Input capacitance	$C_{iss}$	-	73	-	pF	$V_{GS} = 0\text{ V}; V_{DS} = 400\text{ V}; f = 100\text{ kHz}$
Output capacitance	$C_{oss}$	-	20	-	pF	$V_{GS} = 0\text{ V}; V_{DS} = 400\text{ V}; f = 100\text{ kHz}$
Reverse transfer capacitance	$C_{riss}$	-	0.2	-	pF	$V_{GS} = 0\text{ V}; V_{DS} = 400\text{ V}; f = 100\text{ kHz}$
Effective output capacitance, energy related <sup>1</sup>	$C_{o(er)}$	-	27	-	pF	$V_{GS} = 0\text{ V}; V_{DS} = 0\text{ to }400\text{ V}$
Effective output capacitance, time related <sup>2</sup>	$C_{o(tr)}$	-	43	-	pF	$V_{GS} = 0\text{ V}; V_{DS} = 0\text{ to }400\text{ V}$
Output charge	$Q_{oss}$	-	19	-	nC	$V_{GS} = 0\text{ V}; V_{DS} = 0\text{ to }400\text{ V}$
Turn-on delay time	$t_{d(on)}$	-	3	-	nS	See Figure 22
Turn-off delay time	$t_{d(off)}$	-	4	-	nS	See Figure 22
Rise time	$t_r$	-	7	-	nS	See Figure 22
Fall time	$t_f$	-	4	-	nS	See Figure 22

1  $C_{o(er)}$  is the fixed capacitance that gives the same stored energy as  $C_{oss}$  while  $V_{DS}$  is rising from 0 to 400 V

2  $C_{o(tr)}$  is the fixed capacitance that gives the same charging time as  $C_{oss}$  while  $V_{DS}$  is rising from 0 to 400 V

**Table 8 Gate charge characteristics**

Parameter	Symbol	Values			Unit	Note/Test Condition
		Min.	Typ.	Max.		
Gate charge	$Q_G$	-	2	-	nC	$V_{GS} = 0 \text{ to } 6 \text{ V}; V_{DS} = 400 \text{ V}; I_D = 3 \text{ A}$
Gate-source charge	$Q_{GS}$	-	0.18	-	nC	
Gate-drain charge	$Q_{GD}$	-	0.62	-	nC	
Gate Plateau Voltage	$V_{Plat}$	-	2.3	-	V	$V_{DS} = 400 \text{ V}; I_D = 3 \text{ A}$

**Table 9 Reverse conduction characteristics**

Parameter	Symbol	Values			Unit	Note/Test Condition
		Min.	Typ.	Max.		
Source-Drain reverse voltage	$V_{SD}$	-	2.7	-	V	$V_{GS} = 0 \text{ V}; I_{SD} = 3 \text{ A}$
Pulsed current, reverse	$I_{S,pulse}$	-	-	22	A	$V_G = 6 \text{ V}$
Reverse recovery charge	$Q_{rr}$	-	0	-	nC	$I_{SD} = 3 \text{ A}; V_{DS} = 400 \text{ V}$
Reverse recovery time	$t_{rr}$	-	0	-	ns	
Peak reverse recovery current	$I_{rrm}$	-	0	-	A	

## 9. Electric characteristics diagrams

at  $T_j = 25\text{ }^\circ\text{C}$ , unless specified otherwise

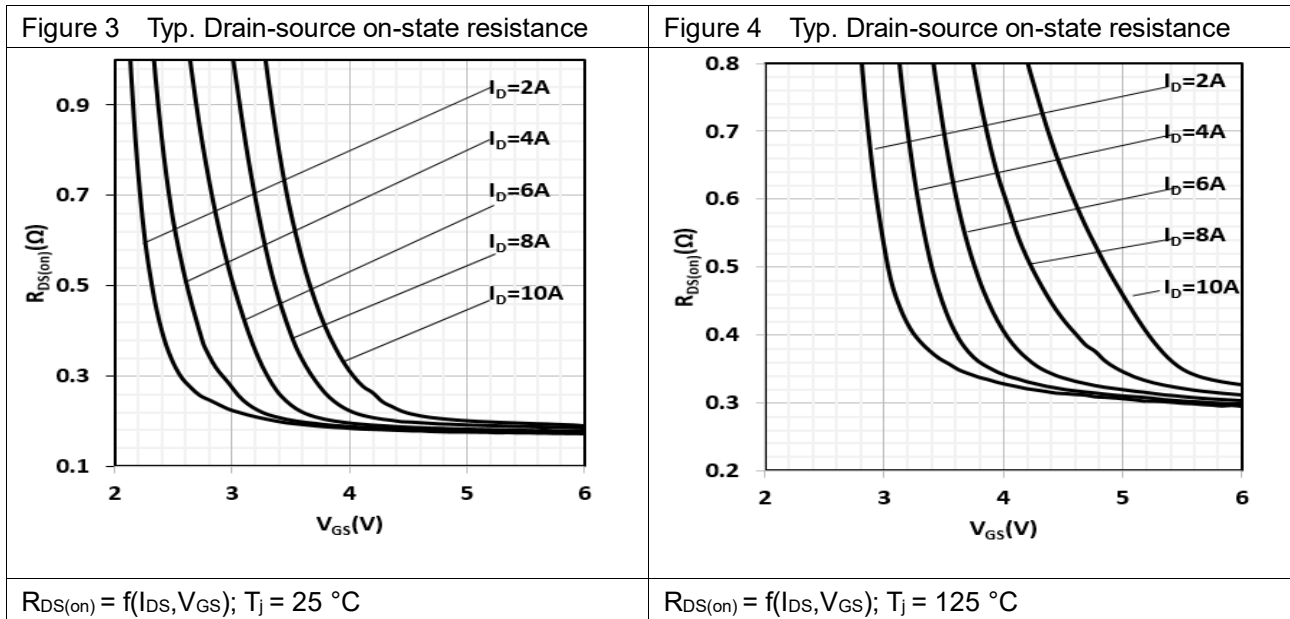
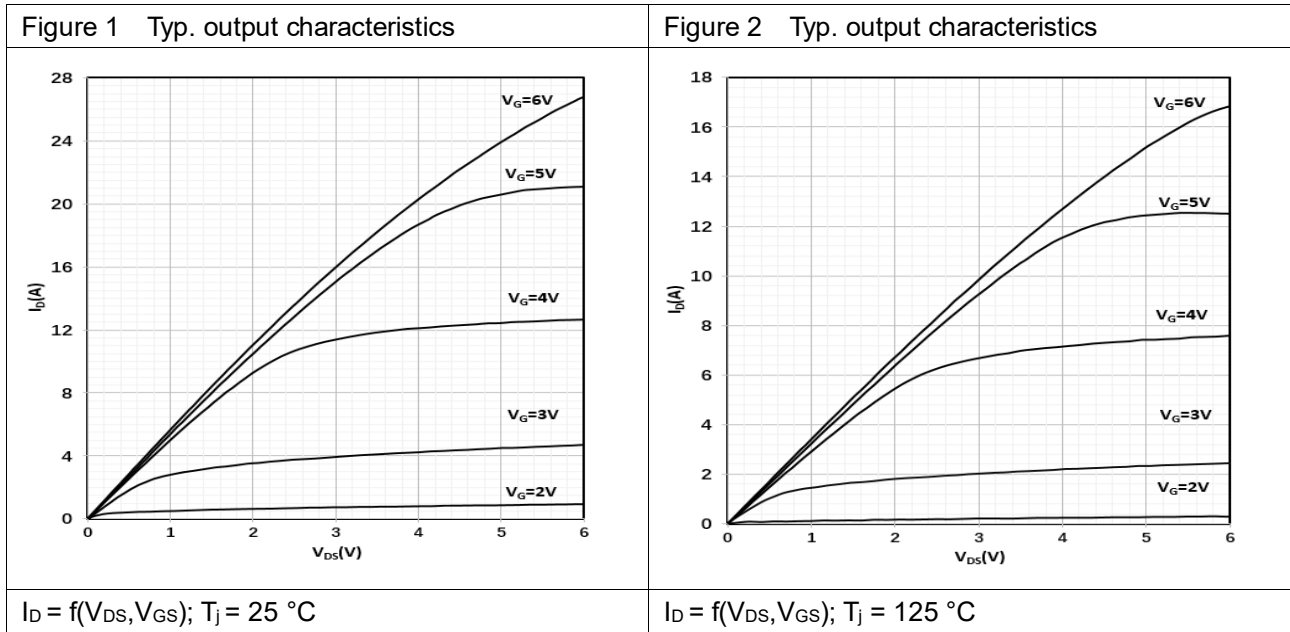
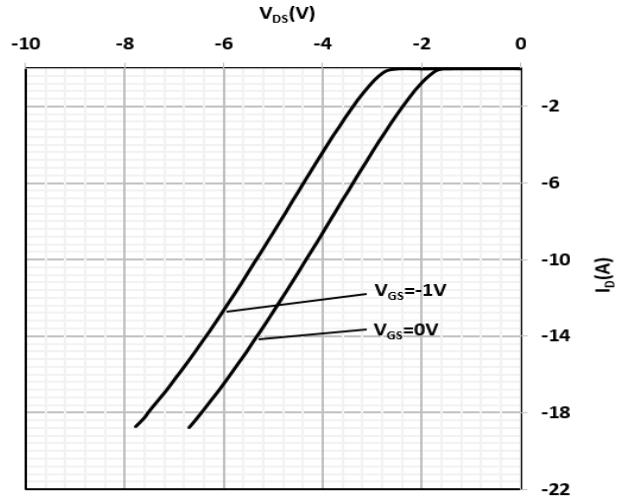
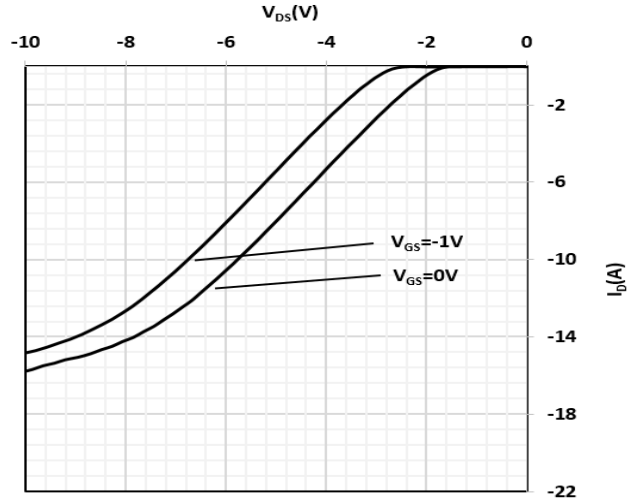


Figure 5 Typ. channel reverse characteristics



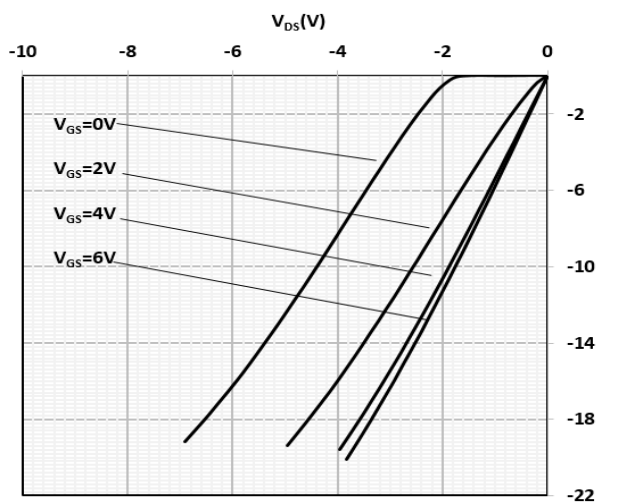
$I_D = f(V_{DS}, V_{GS}); T_j = 25\text{ }^\circ\text{C}$

Figure 6 Typ. channel reverse characteristics



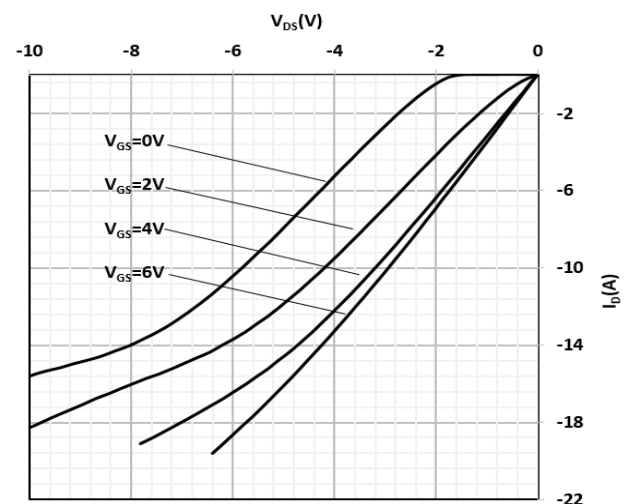
$I_D = f(V_{DS}, V_{GS}); T_j = 125\text{ }^\circ\text{C}$

Figure 7 Typ. channel reverse characteristics



$I_D = f(V_{DS}, V_{GS}); T_j = 25\text{ }^\circ\text{C}$

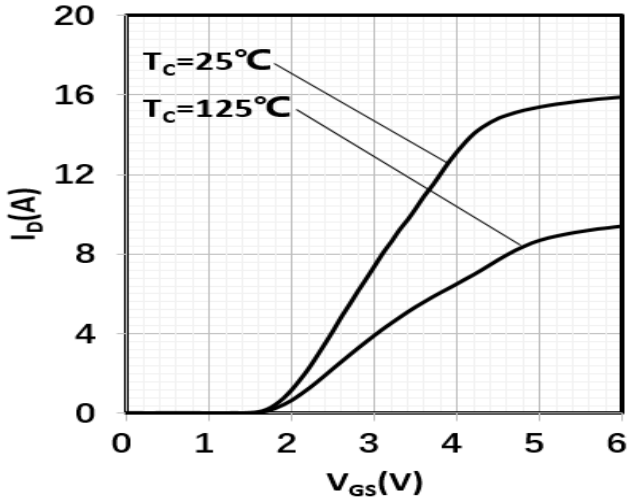
Figure 8 Typ. channel reverse characteristics



$I_D = f(V_{DS}, V_{GS}); T_j = 125\text{ }^\circ\text{C}$

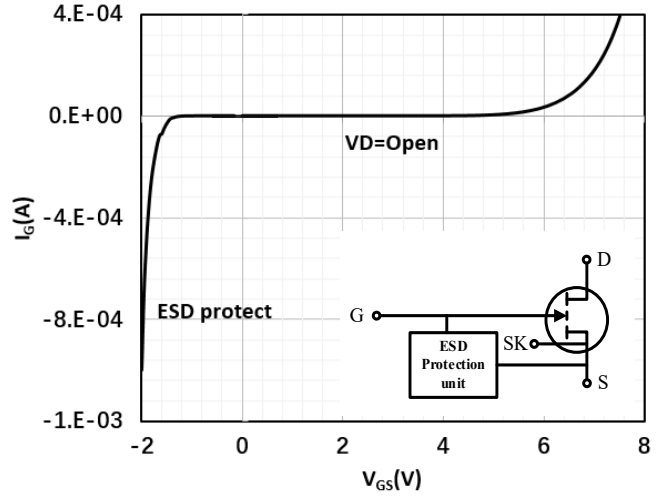


Figure 9 Typ. transfer characteristics



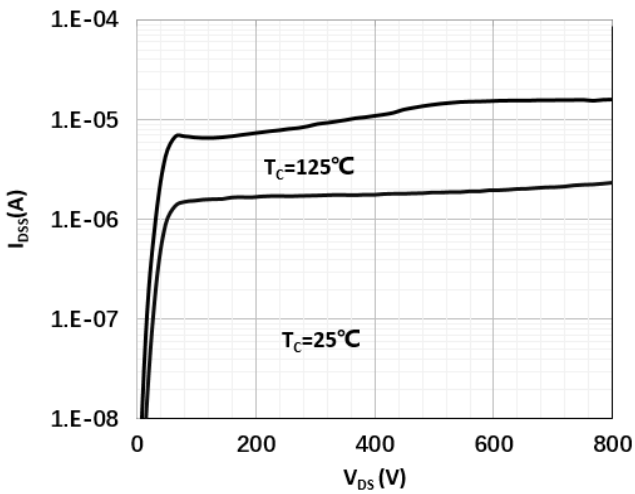
$I_D = f(V_{GS}); V_{DS} = 3\text{ V}$

Figure 10 Typ. Gate-to-Source leakage



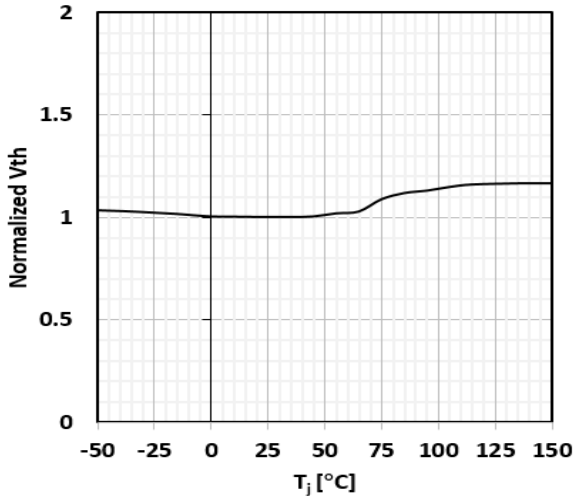
$I_G = f(V_{GS}); I_G$  reverse turn on by ESD unit

Figure 11 Drain-source leakage characteristics



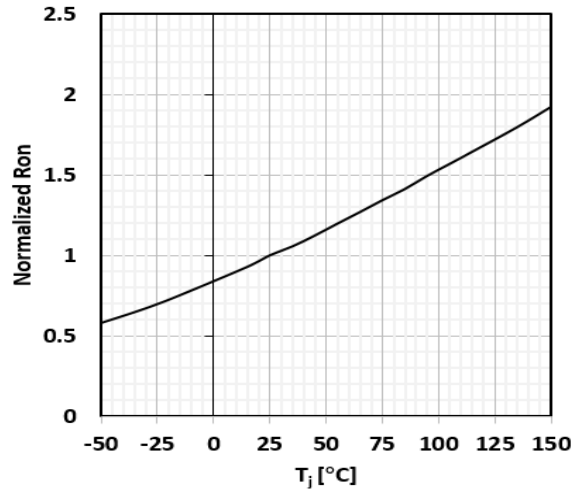
$I_{DSS} = f(V_{DS}); V_{GS} = 0\text{ V}$

Figure 12 Gate threshold voltage



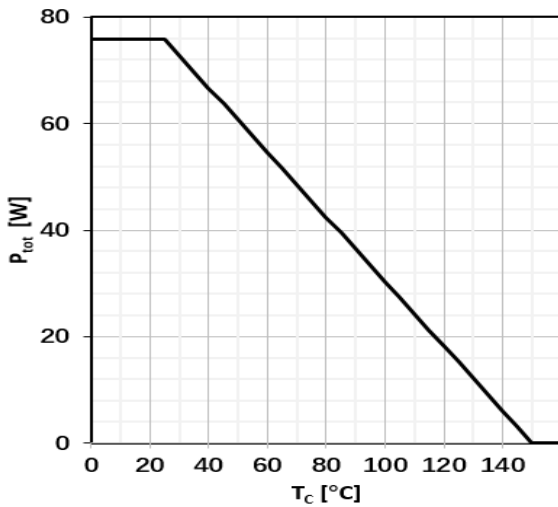
$$V_{TH} = f(T_j); V_{GS} = V_{DS}; I_D = 11 \text{ mA}$$

Figure 13 Drain-source on-state resistance



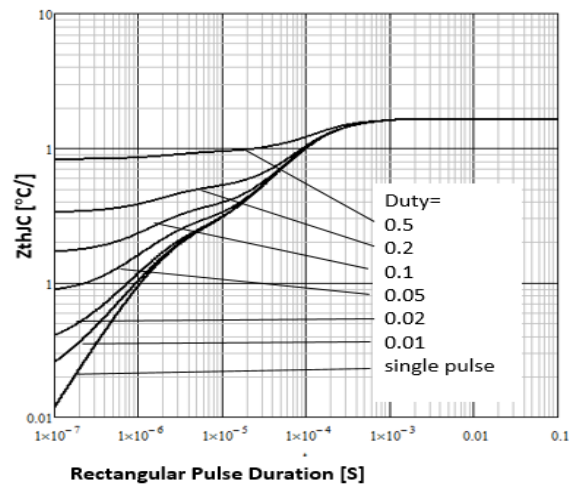
$$R_{DS(on)} = f(T_j); I_D = 3 \text{ A}; V_G = 6 \text{ V}$$

Figure 14 Power dissipation



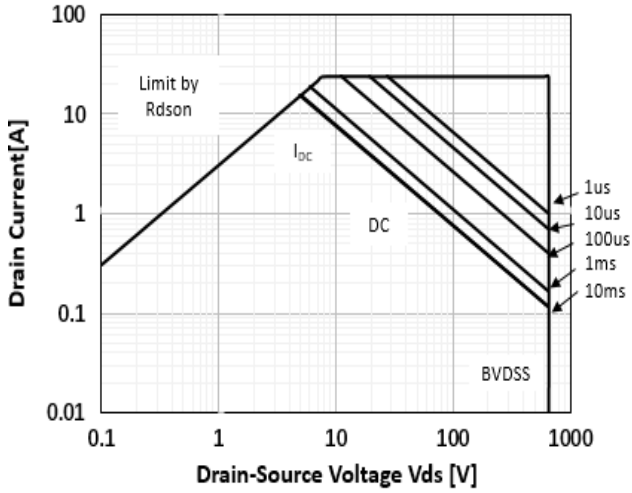
$$P_{tot} = f(T_c)$$

Figure 15 Max. transient thermal impedance



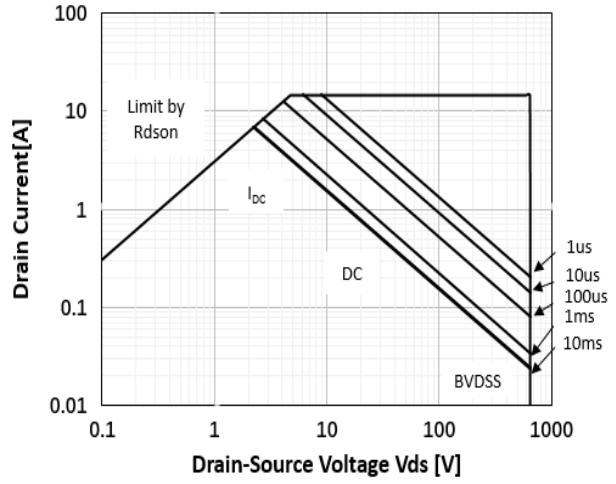
$$Z_{thJC} = f(t_p, D)$$

Figure 16 Safe operating area



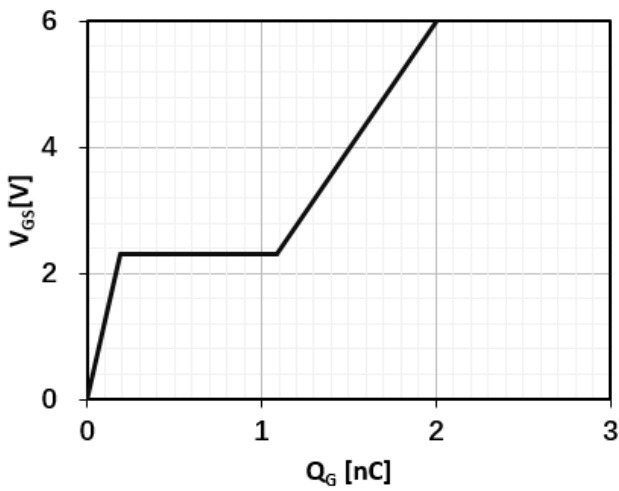
$$I_D = f(V_{DS}); T_C = 25\text{ }^\circ\text{C}$$

Figure 17 Safe operating area



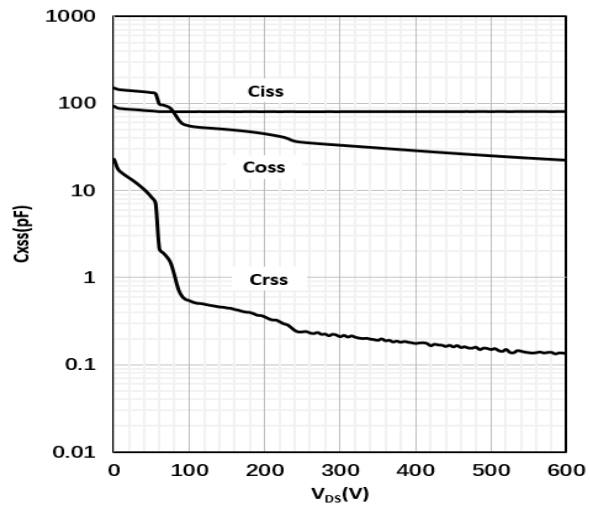
$$I_D = f(V_{DS}); T_C = 125\text{ }^\circ\text{C}$$

Figure 18 Typ. gate charge



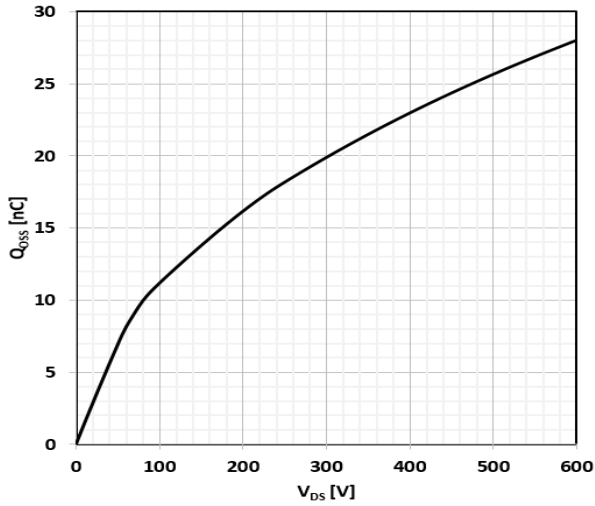
$$V_{GS} = f(Q_G); V_{DCLINK} = 400\text{ V}; I_D = 3\text{ A}$$

Figure 19 Typ. capacitances



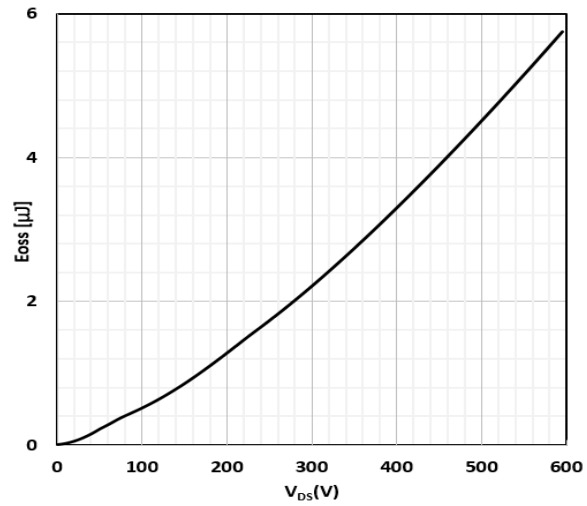
$$C_{XSS} = f(V_{DS}); \text{Freq.} = 100\text{ kHz}$$

Figure 20 Typ. output charge



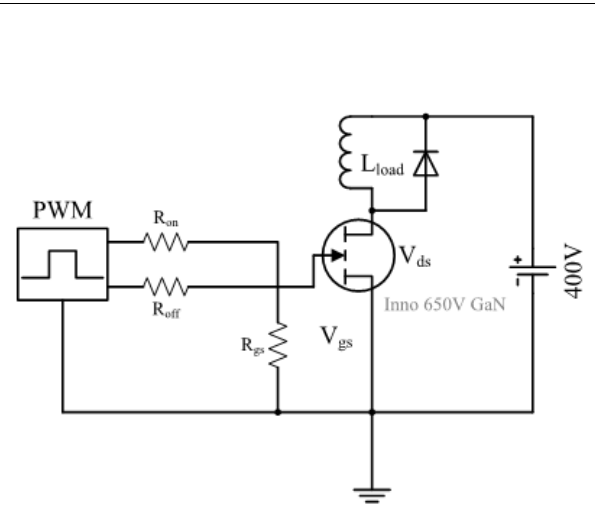
$Q_{oss} = f(V_{DS}); \text{Freq.} = 100 \text{ kHz}$

Figure 21 Typ. Coss stored Energy



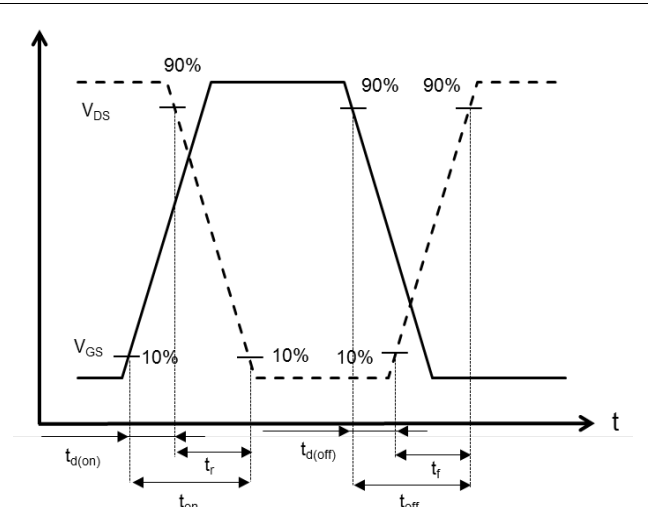
$E_{oss} = f(V_{DS}); \text{Freq.} = 100 \text{ kHz}$

Figure 22 Typ. Switching times with inductive load

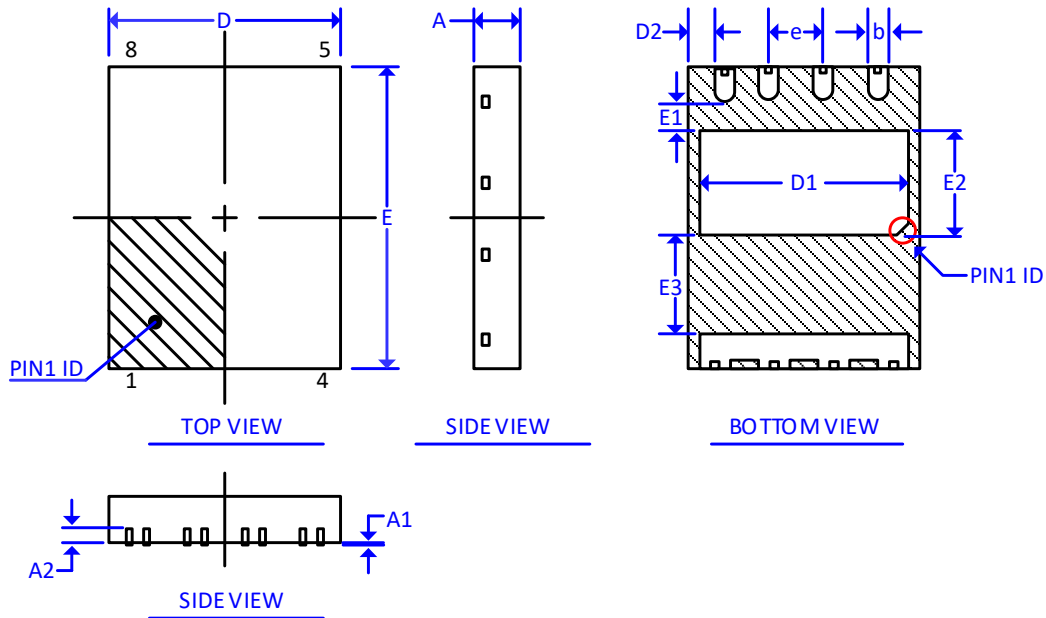


$V_{DS}=400V, I_D=3A, L_{load}=800\mu H, V_{GS}=6V, R_{on}=10\Omega,$   
 $R_{off}=2\Omega, R_{gs}=10k\Omega$

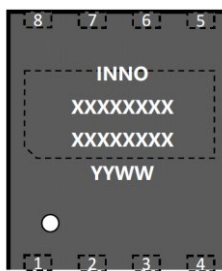
Figure 23 Typ. Switching times waveform



## 10. Package outlines



SYMBOL	DIMENSION			SYMBOL	DIMENSION		
	MIN	NOM	MAX		MIN	NOM	MAX
A	0.80	0.90	1.00	E	6.00 B.S.C		
A1	0.00	0.02	0.05	E1	0.40	0.50	0.60
A2	---	0.203 ref	---	E2	1.95	2.05	2.15
b	0.40	0.45	0.50	E3	---	2.1	---
D	5.00 B.S.C			e	1.27 B.S.C		
D1	4.16	4.26	4.36	L	0.575	0.675	0.775
D2	0.27	0.37	0.47				

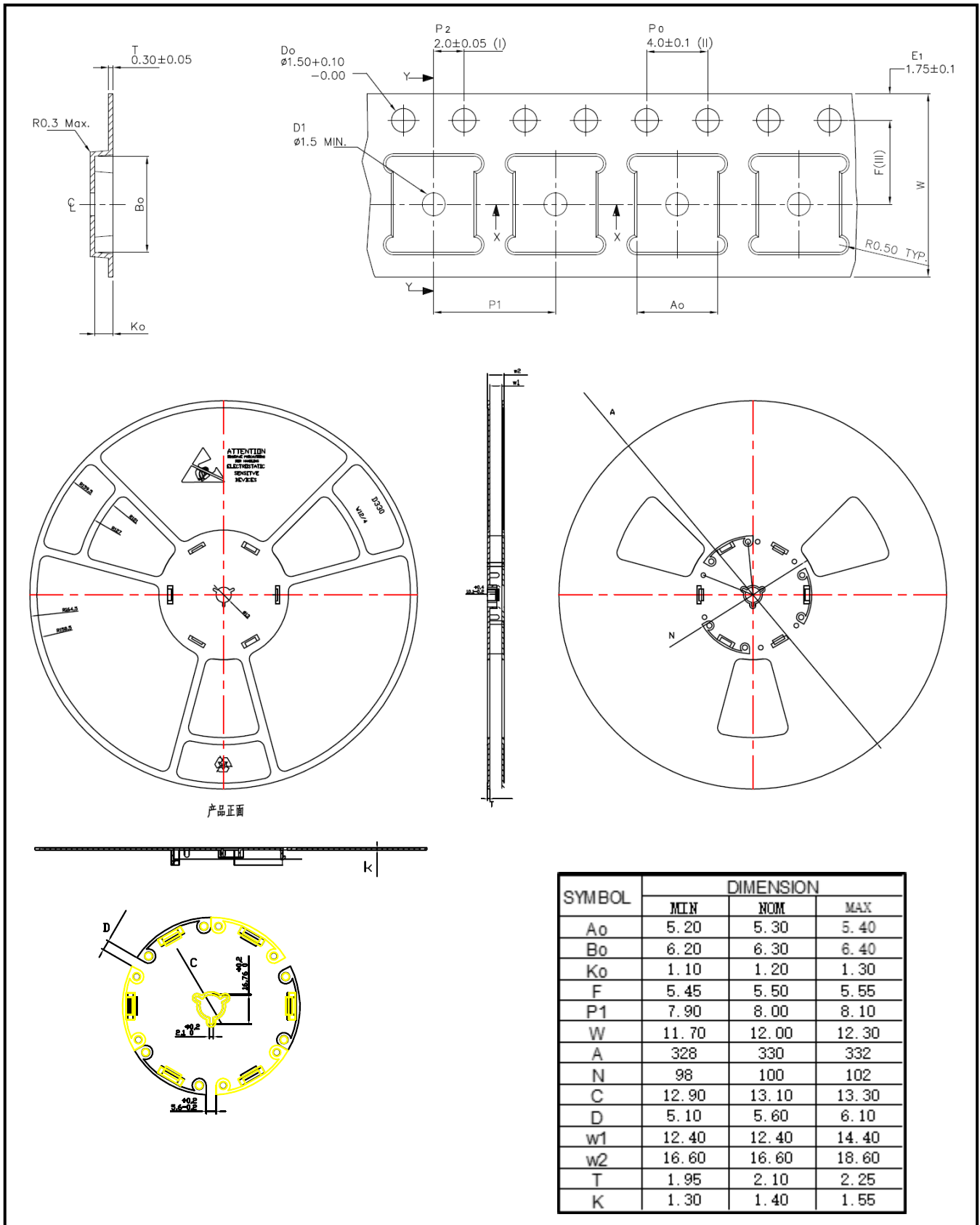


Row	Description	Example
Row1	Company name	INNO
Row2	Product code (In short)	XXXXXXXX
Row3	ASSY lot No.	XXXXXXXX
Row4	Date code	YYWW

**Notes:**

- (1) Dimension and tolerance conform to ASME Y14.5-2009.
- (2) All dimension are in millimeters.
- (3) Lead coplanarity shall be 0.1 millimeters max.
- (4) Complies with JEDEC MO-229.
- (5) Drawing is not to scale.

## 11. Reel information



## 12. Revision history

### Major changes since the last revision

Revision	Date	Description of changes
1.0	2021-4-23	1.0 version release

### Important Notice

The information provided in this document is intended as a guide only and shall not in any event be regarded as a guarantee of conditions, characteristics or performance. Innoscience does not assume any liability arising out of the application or use of any product described herein, including but not limited to any personal injury, death, or property or environmental damage. No licenses, patent rights, or any other intellectual property rights is granted or conveyed. Innoscience reserves the right to modify without notice. All rights reserved.