

Operation Manual

Chap. 1 Attention

Please read the attention carefully before operating the machine.

1. No magnetic devices should be placed in the vicinity of the plotter, specifically the carriage.
2. Prevent from dropping foreign matters into cracks such as pins, little screws, etc.
3. Please pull out the power plug if not using during a long time.
4. Don't plug or unplug serial/parallel/usb cables on plotter while the power is on
5. Don't leave pinch rollers pressed down while machine is not in use.
6. Always connect the power cord to a grounded outlet.
7. Don't move the carriage manually.
8. Don't touch carriage, metal roller, cutter and all moving devices when the machine is working.
9. Place machine in a stable area that is free of strong vibrations, electromagnetic field, dust, moisture and /or direct sunlight.
10. Don't press top beam or lift up black rail.

Operation Manual

Chap. 2 Installation

2-1 Packing-box

Please carefully check up the goods after opening the packing box, and in every box there should be as following:

1. A main machine.
2. A packet of accessories.
3. A set of parts of machine stand.

2-2 Accessories

NO.	Item	Quantity
1	Power cord	1
2	Operation manual	1
3	Cutter holder	1
4	Cutter	3
5	Plotter holder	1
6	Allen wrench	1
7	Serial cable	1
8	Parallel cable(optional)	1
9	USB cable (optional)	1
10	Plotter protective cover	1
11	Driver disk for CorelDraw and USB port	1
12	Artcut 2009 CD (optional)	1

2-3 Parts of stand

NO.	Item	Quantity	NO.	Item	Quantity
1	Left column	1	6	Paper roller	2
2	Right column	1	7	Paper hanger	2
3	Crossbeam	1	8	Connection board	2

Operation Manual

4	Pillar-bars	2	9	Screw M4×20	10/12
5	Pillars/wheels	4	10	Screw M4×8	8

2-4 Assembly of machine stand

Referring to the following drawing:

(Available to the type with minimum width 780mm only)

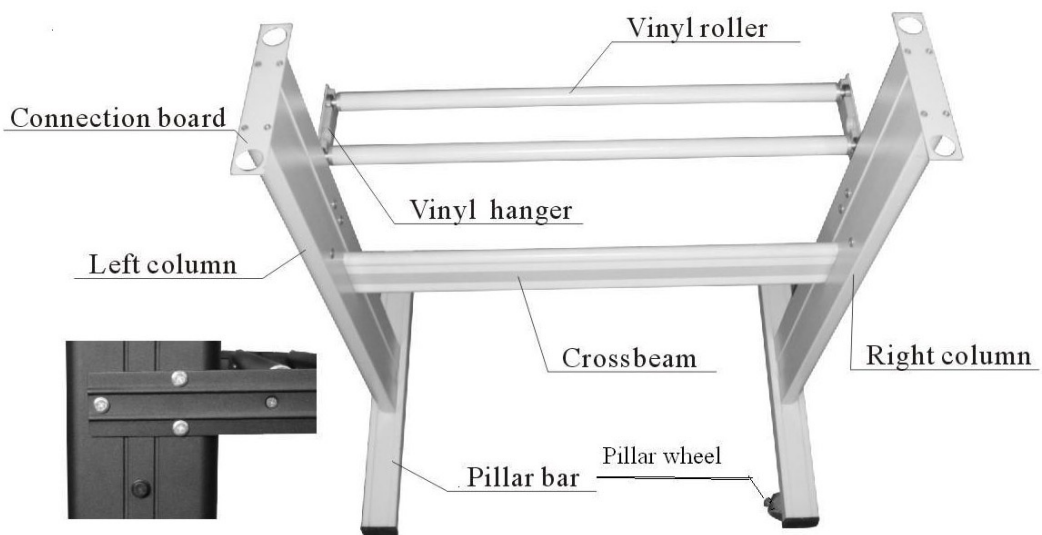

Step 1: Connect the pillar bars to left and right columns with screws respectively.

Step 2: Connect the crossbeam to left and right columns with screws.

Step 3: Join the paper hanger to the inside of the left and right columns with screws.

Step 4: Join the connection board to the top of the left and right columns with screws.

Step 5: Lay down the four pillars of main machine, place the machine on the connection board, and then insert the pillars into the connection board to connect to the main machine.

Step 6: Place the paper-roller on the roller of paper hanger.

Operation Manual

Chap. 3 Basic operation

3-1 Installation and connection

- 1 Place the machine in a plane and roomy place
- 2 Connect the signal cable to the COM1,COM2 /USB port of the computer
- 3 Check voltage of the power source and whether it is grounded, do not connect the power until all are in a good condition

3-2 Installation of tool

3-2.1 Structure of cutter holder and items of components

Rotate the cutter adjusting screw to adjust the out-stretching length of the cutter as to ensure that it doesn't cut off the bottom layer of stickiness.

1. Cutter (diameter is 2mm)
2. Cutter holder shell
3. Cutter adjusting screw
4. Cutter holder body

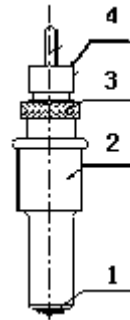

3-2.2 Installation and adjustment of blade

1. Before installing the cutter, you must carefully clean the cutter holder body, the cutter and your hands. Even very slight dirt can affect the performance of the cutter. Use a flexible plastic or rubber grip to hold the blade in your hand. Carefully insert the blade into the cutter holder body and it should magnetically attach.

Operation Manual

- 2 Rotate the shell of the cutter holder and make the out-stretching length of the blade tip not longer than the thickness of the sticker
3. Don't touch the blade top with your finger to prevent injury

3-2.3 Structure of Plotter holder and items of components

Fit the the ball pen into the plotter holder , the structure is as shows in the following drawing .

1. Rotate the lid.
2. Insert a ballpoint pen and let the pen tip out of proper length.
3. Cover the pen with the lid then rotate them into the shell

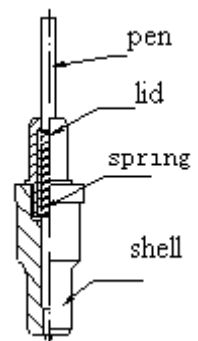

3-2.4 Installation

1. Turn off the power
2. Loosen the locking screw of the tool carrier , then put the cutter holder or plotter holder in the tool carrier When the tool are in appropriate .position , fasten the locking screw clockwise at last.

3-2.5 Using life of the cutter

Cutter's using life is limited, but you can use it as long as possible.

Note:

1. More longer the out-stretching length of the cutter, more shorter the using life. Please avoid cutting off the bottom layer during the process of cutting.
2. The more cutting force, the shorter the using life.
3. As for different materials, the requirement to the cutter sharpness is different.
4. Set the cutting force as little as possible; only increase it when the cutter feels blunt.

Operation Manual

5. As for the cutters from different factories, the using life is also very different.
6. Renew the cutter timely when it is blunt in case of affecting the machine performance. As an urgent method, a piece of leather can be used to sharpen the blade tip just like sharpening a razor.

Chap. 4 USB Port Setting

340 USB Driver Setting

1. Install USB port:

Attention: Before install the CD, don't connect cutting plotter with computer

Insert Driver CD into your CD ROM of computer, Find this file in the CD. Double click this file

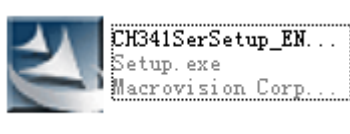

Click the "NEXT", driver program will be installed automatically.

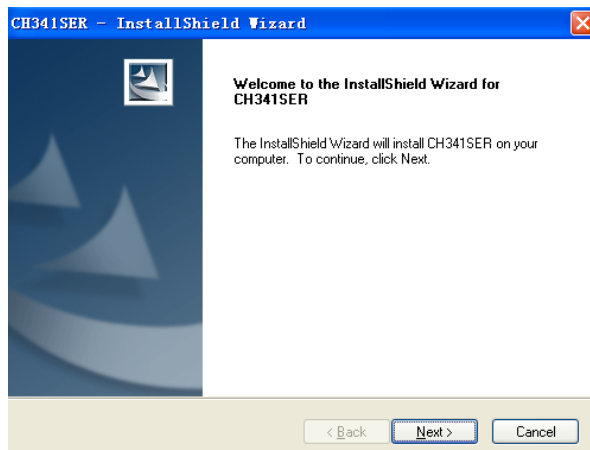

Operation Manual

Click “OK”, the driver program is installed well

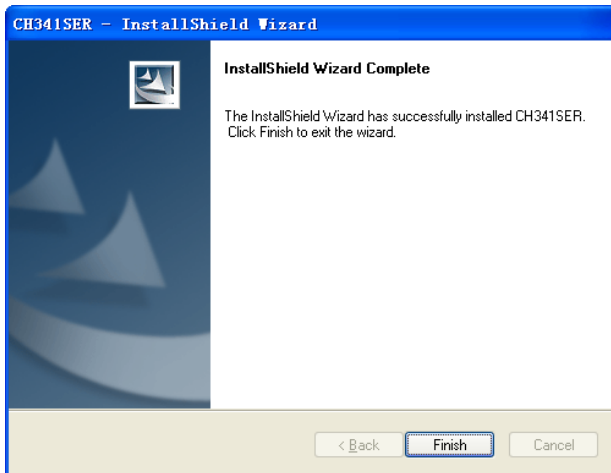

Now connect USB cable of the cutting plotter with USB port of computer . The USB device will be found as “COM3” from “ Device Manager”. It testifies that the machine is connected with computer successfully

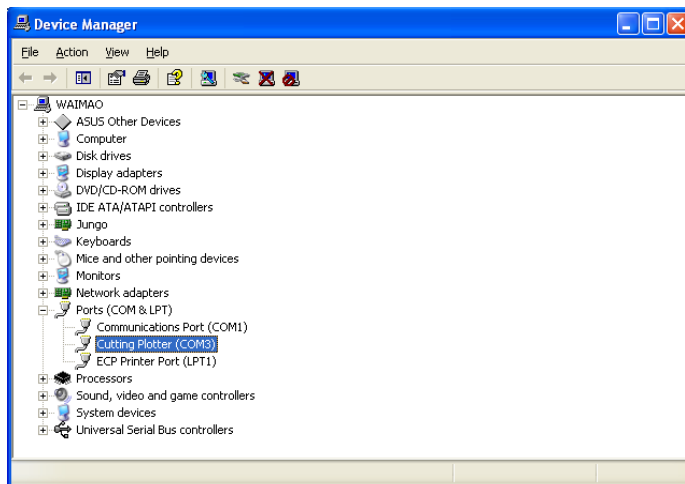

2. Set port in Artcut software

Operation Manual

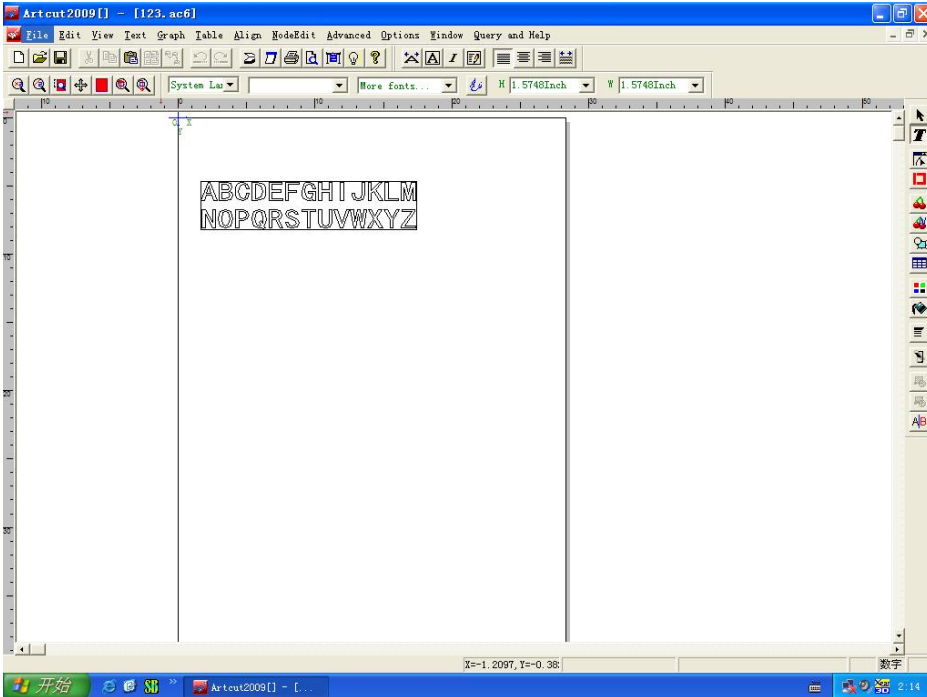

Please choose COM 3 for USB port in "Link to "

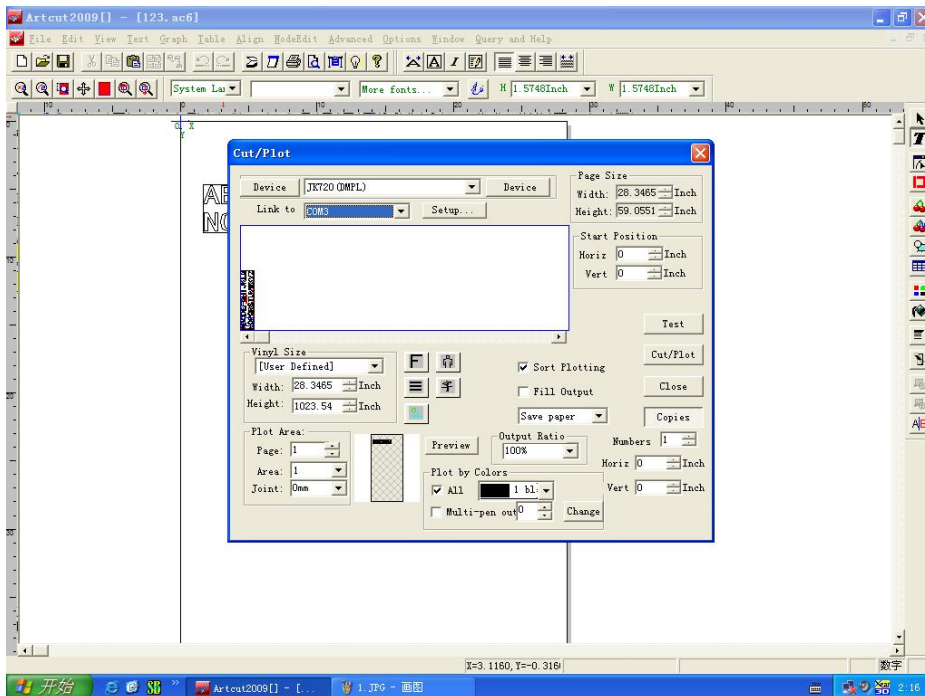

Operation Manual

In “Sequential Control” please choose DTR/DSR and RTS/CTS

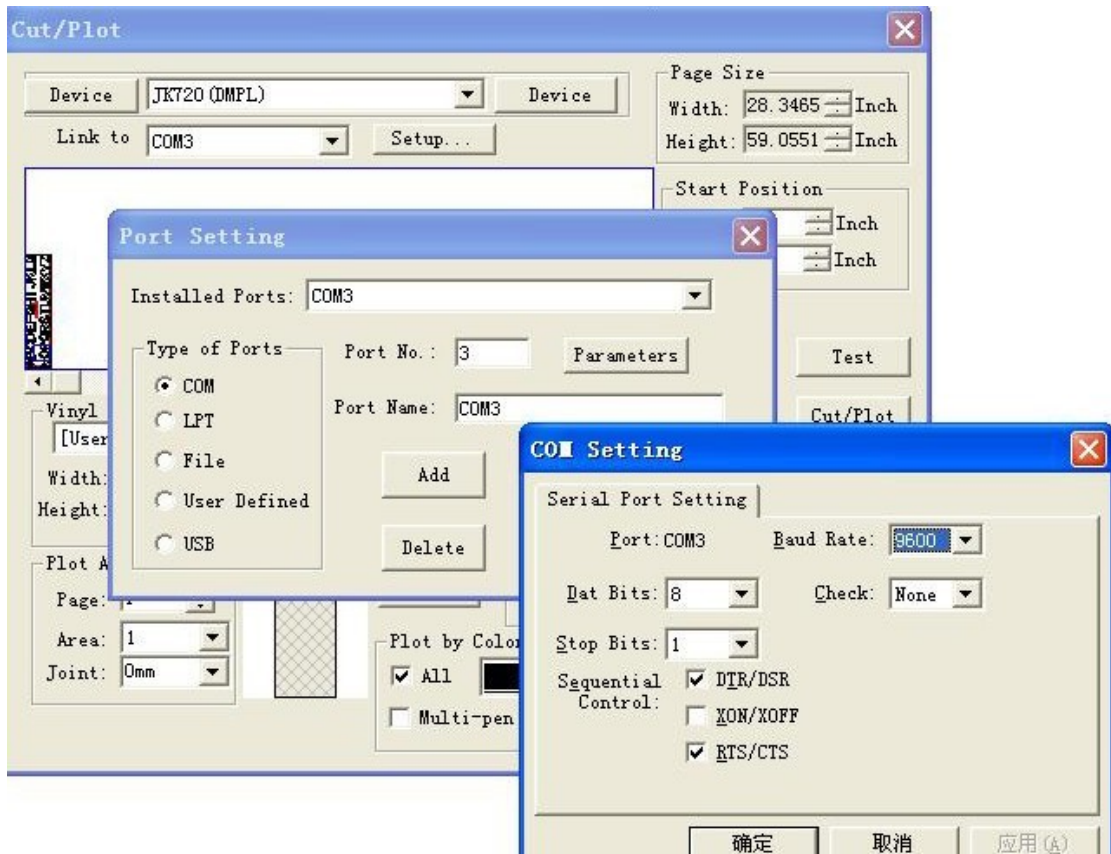

3. After finishing all of these installations please restart computer

Operation Manual

Chap. 5 Operating Instruction

5-1 Names and functions of the parts

5-1.1 Item of the component

_0Type

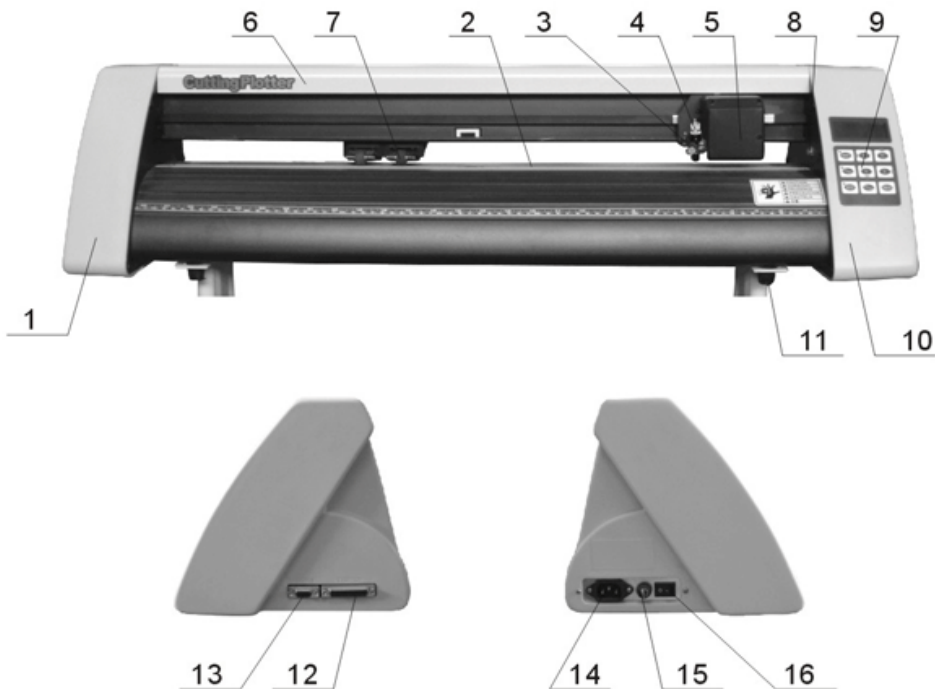

- | | |
|--------------------------|----------------------|
| 1. Left cover | 9. Controlling panel |
| 2. Metal roller | 10. Right cover |
| 3. Cutter bracket | 11. Pillar |
| 4. Cutter holder | 12. Serial port |
| 5. Carriage | 13. Power socket |
| 6. Cover of guide | 14. Fuse socket |
| 7. Pinch roller | 15. Power switch |
| 8. position setting knob | |

Operation Manual

_1 Types

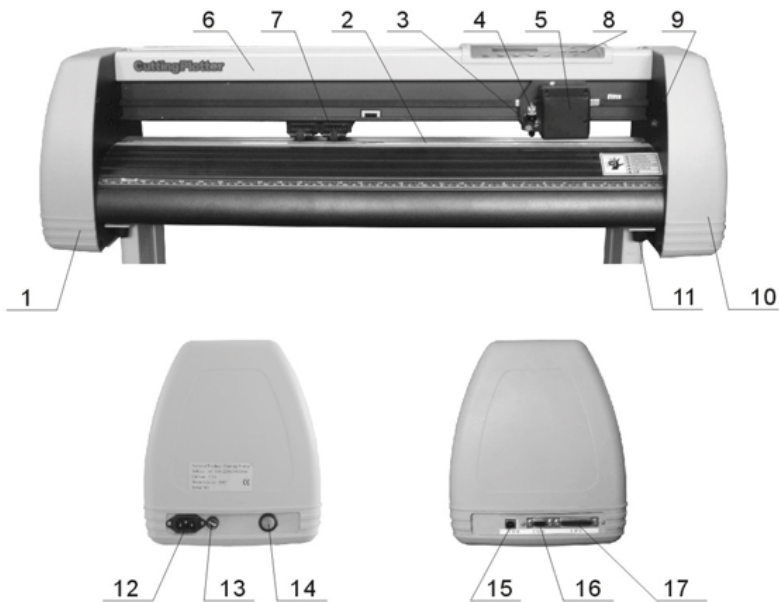

- | | |
|--------------------------|---|
| 1. Left cover | 10. Right cover |
| 2. Metal roller | 11. Pillar |
| 3. Cutter bracket | 12. Power socket |
| 4. Cutter holder | 13. Fuse socket |
| 5. Carriage | 14. Power switch |
| 6. Cover of guide | 15. USB to serial adapter port (optional) |
| 7. Pinch roller | 16. Serial port |
| 8. Controlling panel | 17. Parallel port (optional) |
| 9. Position setting knob | |

5-1.2 Control Panel

Operation Manual

_0 Type

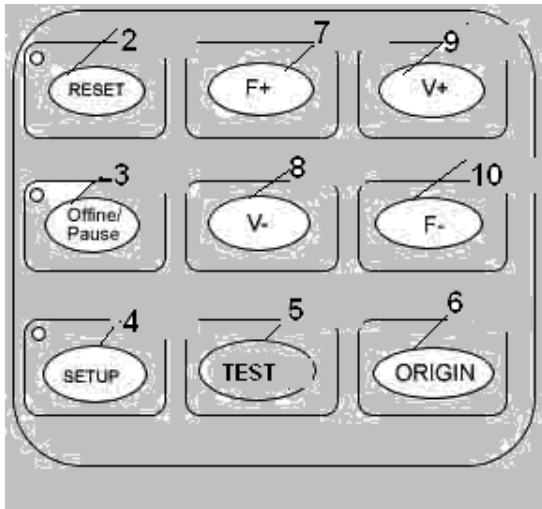

_1 Type

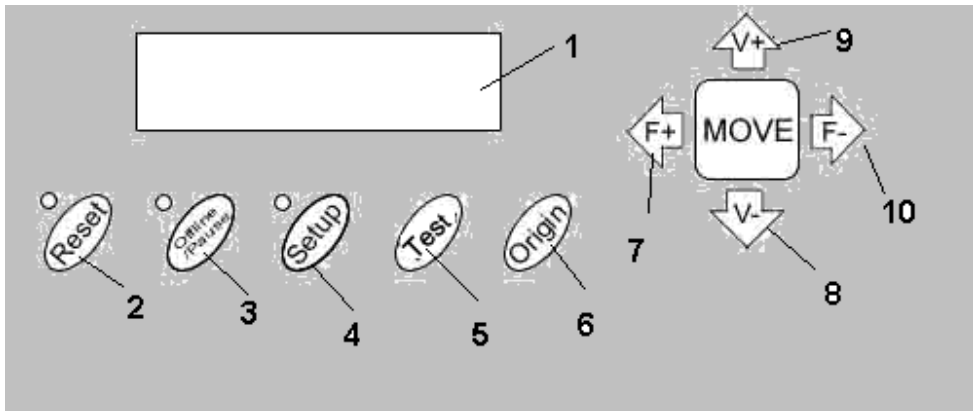

- | | |
|--------------------|--------------------------|
| 1. LCD display | 6. origin setting button |
| 2. Reset | 7. Force + |
| 3. Offline / Pause | 8. Value - |
| 4. Setup | 9. Value + |
| 5. Test | 10. Force - |

5-2 Basic Operation

Operation Manual

5-2.1 Turn on the machine

1. . Check whether the power is in OFF position
- 2.. Plug the power cable into the power socket of the machine , and then press the switch on / off on the left
3. LCD in the control panel is on and displays the initializing process and shows following information

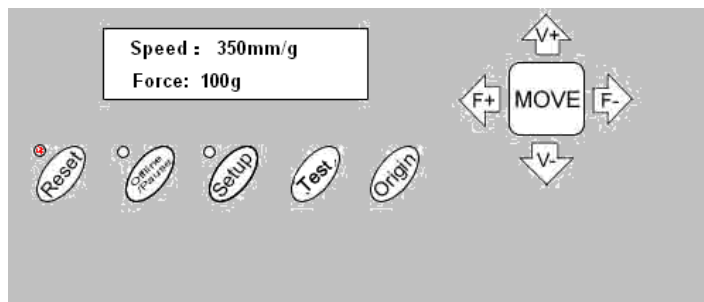
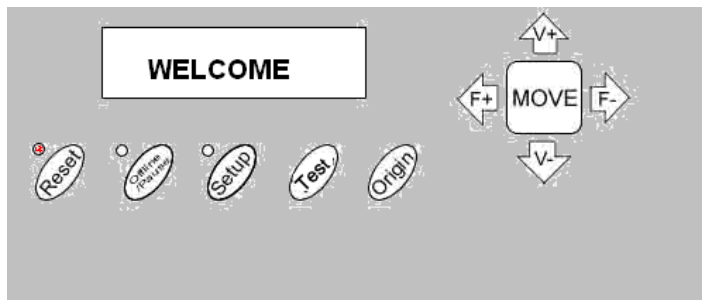

- 4 When the initializing is over , the red light is on, the machine is in online state and connectable with the computer to be operable

5-2.2 Installation of the cutting media

Operation Manual

1 Loading the cutting media

1. Lift the pinch-roller handles and let it away from the metal rollers.
2. Insert the vinyl between metal rollers and pinch rollers of the machine from behind to front.
3. Carefully check the vinyl before cutting, since if vinyl is not well placed, serious deviation will occur. If the vinyl is uneven lift the pinch rollers on one side to adjust and then press down pinch rollers. It is necessary to trial-run the vinyl several times to attain minimum deviation before cutting work.

2 Adjust the place of pinch rollers according to paper width

Cutting plotter has 2 to 4 pinch rollers and they can be moved along the guide rail. The handles of pinch rollers must be lifted before moving pinch rollers, hold the back of the roller and push it to the left or the right. Please don't pull the roller bars in the front, otherwise the machine precision will be affected.

3 The place of the rollers must ensure:

1. Pinch rollers should be in the place out of the scope of the pattern.
2. Pinch rollers should be 10 to 50mm away from the edges of the paper.
3. Pinch rollers shouldn't be let down on the conjunction of two connecting metal rollers.

5.2.3 Trial run (adjusting the force and tool)

Operation Manual

1 Test Cut

Once the blade/plotter is installed and the vinyl is inserted, preliminary test-cut should be carried out to check the force of the blade/plotter if it is acceptable. To do so, press the TEST key. and shows as following . Then the machine will automatically cut a pattern

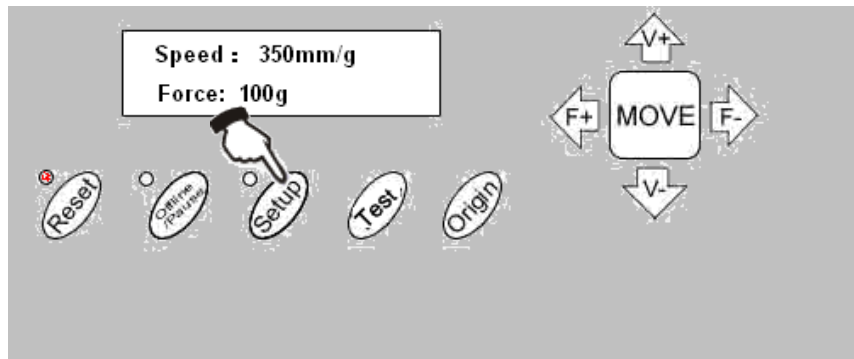

2 Force Adjustment

Take off the cutted pattern , if you fail, the pattern need to be further cut , because the force is too low or the protruding length of the blade top is too short . If the base paper is pierced through, it signifies that the protruding length of the blade top is too long and the force is too big. The protruding portion of the blade tip should be about 0.5mm or less in length normally which is 2/3 of the thickness of vinyl. Adjust the protruding length of the blade top and forcess according to result of test

By pressing F+ or F- the force of the blade will be increased or decreased by one level..

Caution:

Always test cut every time you use a new type of vinyl to check the cutting force

5-3 Operating instruction

Operation Manual

5-3.1 Reset

When the power is turned on, the machine can automatically reset.. the red light is on and the machine is ready to receive the data from the computer. As this point the LCD shows as following

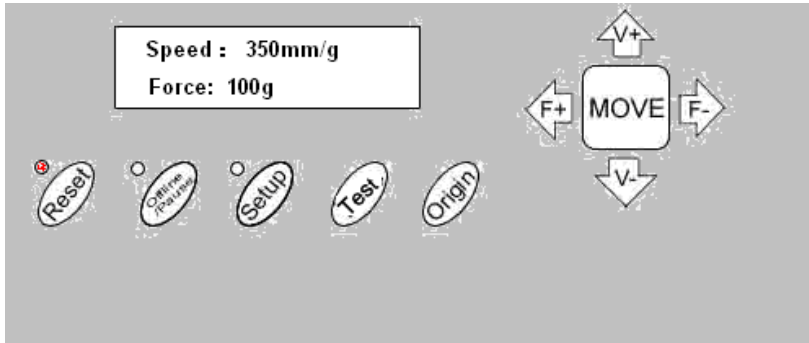

The default setting is as following :

- Baud rate: 9600
- Cutting speed: 350mm/s
- Cutting force: 100g
- Cutting origin is according to the default of the machine

The above information may be changed during operation.

When it is working, if the RESET key is pressed, the machine will cancel the current job and return to default settings

5-3.2 Online

Operation Manual

After the machine is reset, the red light (reset indicator) should be on. When the machine receives data from the computer, it is in online mode.

In this moment you can change the cutting speed by pressing V+ or V- adjust the cutting force by pressing F+ or F

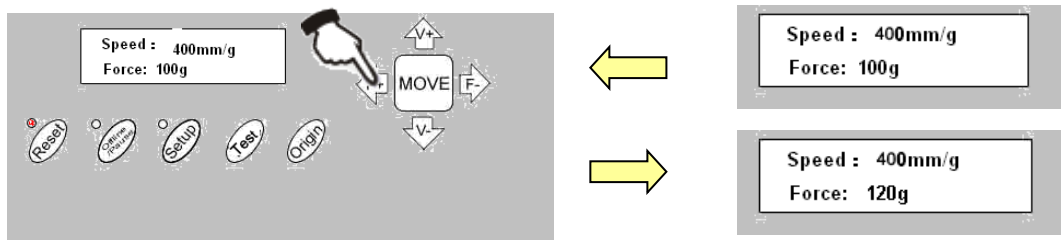
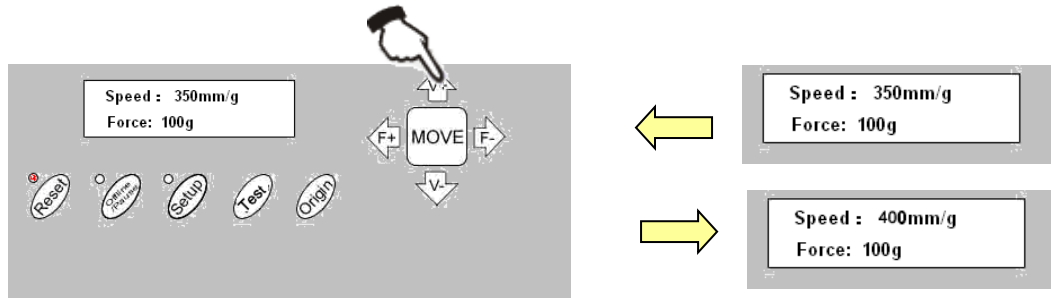

When it is working, if the RESET key is pressed, the machine will return to default settings and reset mode---clear up all information, and get ready for new work.

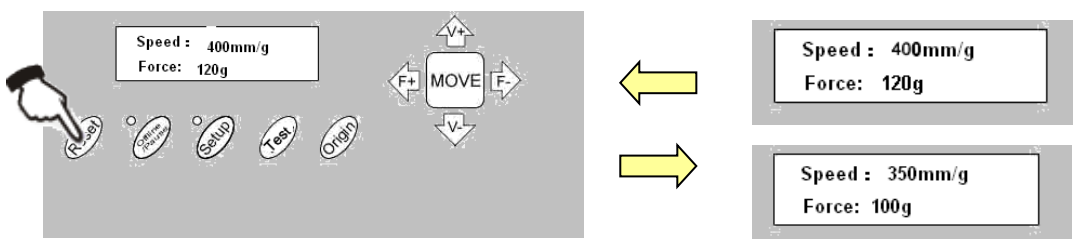

5-3.3 Offline /Pause

Operation Manual

Press the OFFLINE key to enter offline mode. The yellow light is on.

Meanwhile, “Motion, X= xxx, Y= yyy” will appear on LCD, which shows the coordinates location of the blade at the moment.

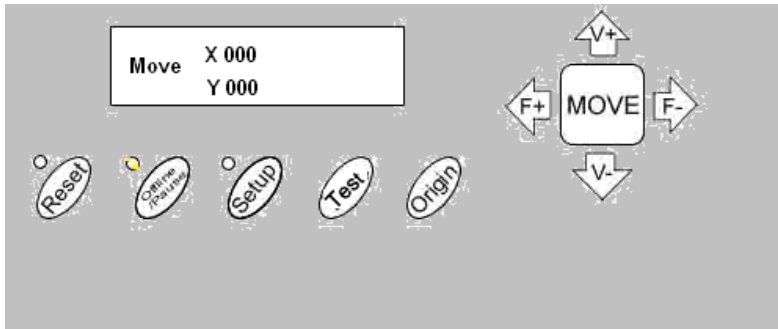

Press the key V+ or V- the carriage can be moved left or right. Press the key F+ or F- the vinyl can be moved forward or backward., In this state you can move the blade top to the starting position. the step value of “X, Y” in the LCD will change accordingly

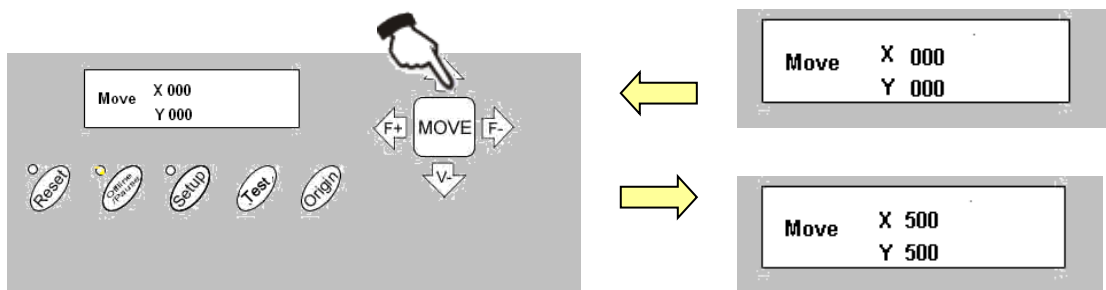

When it is working you press the Pause Key , the machine will stop working and if you press again the machine will continue working

5-3.4 Setting origin of plotting

Operation Manual

When move the blade top to the starting position , press the Origin button the setting of the new origin is completed , The machine will start plotting from the new origin.

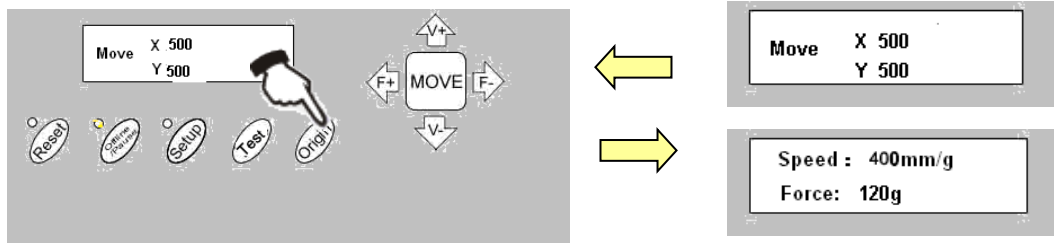

5-3.5 Setup

In ONLINE status, when you press the SETUP key, the green light is on, and the baud rate of serial port can be changed. If you press SETUP key again, it will restore to online status.

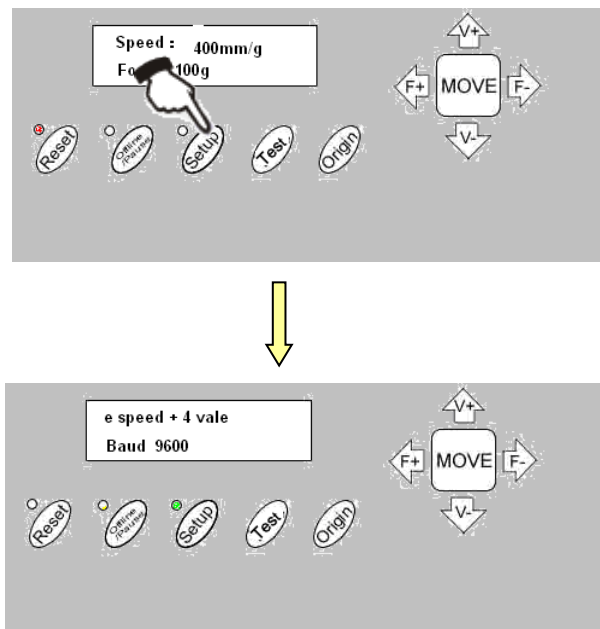

Caution:

Unless professional technicians, you're not suggested to change this setting.

5-3.6 Copy Function

Operation Manual

Press the OFFLINE, SETUP and ORIGIN keys the machine will re-cut all the data output of the last setting. The machine won't re-cut if the green RESET light is flashing, it means the output data is more than the buffer capacity. In this case press RESET to restart the cutting work.

Caution:

If something unusual occurs and you are unable to stop the cutter, turn the power off or unplug it

5-3.7 After work is over

After work is over...

- 1.Remove the paper.
- 2.Remove the cutter holder or plotter holder, then wipe it clean with a soft-cloth and keep it properly.
- 3.Turn off the power, and pull the power cord out if not using during a long time.
- 4.Cover the machine with a cloth or a cover.

5-4 Parameters Table

Operation Manual

Technical Specifications (_0 Type)

Technical Specifications (_1 Type)					
Model	361	721	871	1101	1351
Max. paper width	365mm	720mm	870mm	1100mm	1350mm
Model	360	720	870	1100	1350
Max. paper width	365mm	720mm	870mm	1100mm	1350mm
Max. cutting width	275mm	630mm	780mm	1010mm	1260mm
Cutting speed	50-800mm/s				
Cutting force	50-500g				
Buffer capacity	1M				
LCD	Optional				
CPU	8-bit CPU				
Strip of plotter	Plastic sheet				
Drive	Stepping				
Min. character matrix	Approx 5 mm [0.2"] high				
Blade type	Super steel [1.2mm and 2.0mm]				
Film type	Self -adhesive vinyl film, fluorescent film, reflective film, paper				
Display panel	8digits X 2 line LCD				
Interfaces	parallel & serial				
Power requirements	90-260V				
Repeatability	0.0127mm				
Mechanical resolution	0.0254mm/step				
Commands set	DMPL / HPGL				
Environmental temperature	0-35°C				
Environmental humidity	5%-65% (without condensation)				

Operation Manual

Max. cutting width	275mm	630mm	780mm	1010mm	1260mm
Cutting speed	10-800mm/s				
Cutting force	10-500g				
Buffer capacity	1-4M				
LCD	YES				
CPU	8-bit CPU				
Special setting	Dual cutter position, dual strips				
Strip of plotter	Double sheet(soft sheet and plastic sheet)				
Drive	Stepping				
Min. character matrix	Approx. 5 mm [0.2"] high				
Blade type	Super steel [1.2mm and 2.0mm]				
Film type	Self -adhesive vinyl film, fluorescent film, reflective film, paper				
Display panel	8digits X 2 line LCD				
Interfaces	Parallel & serial, USB				
Power requirements	90-260V				
Repeatability	0.0127mm				
Mechanical resolution	0.0254mm/step				
Commands set	DMPL / HPGL				
Environmental temperature	0-35°C				
Environmental humidity	5%-65% (without condensation)				

Chap. 6 Troubleshooting

Why is the pattern deformed or incomplete?

Operation Manual

1. More pressure or too long blade tip or too dirty platen or too soft stickiness, all of these factors can cause more resistance to the two faces of paper and make it fall behind the roller rotating, thus result in deformed pattern.
2. The software setting isn't proper. (The tool compensation value is too big)
3. The carriage belt is too loose, or the metal roller can't exactly follow the motor running.
4. The motor doesn't run all the steps.
5. The pattern is normal but not complete, this may be resulted from too small tool compensation value.

Why does the machine plot abnormally?

1. Software setting is not matched to the machine, so you must adopt proper commands set or set proper tool compensation value.
2. The plotting software is suddenly broken up.
3. Plotting software has been damaged or there is virus in computer.

Why does the paper run deviation?

1. The stickiness isn't placed right.
2. The platen is too dirty so that the resistance from two sides can't be balanced when the paper is moving.
3. The pinch rollers have been deformed or don't match to each other.
4. The pressure of the pinch roller is a little smaller and the paper is very sensitive to the external force.
5. The balance of the stickiness weight isn't very good.

Why some parts of letters are missing?

1. The vinyl is too heavy or too tightly wrapped. Metal roller might be soiled by some foreign substance or by vinyl chips.

Operation Manual

2. Cutting speed is too fast, cutting force is too great, or cutter tip is too long.
3. Synchronesh belt is too tight, or pinch roller is under too much pressure.
4. Metal roller is faulty. Contact local distributor for repairs and replacement.

Why different letters on the same line are cut to different depths?

1. Cutter holder is not tightly attached. It should be tightened.
2. Cutter blade is not tightly set in the holder.

Why letters appear to have ripples?

1. Cutting speed is too fast. Except for cutting large letters, speed should not exceed 480mm/s.
2. Cutting blade is of poor quality, or it has been damaged. Replace it.
3. Cutter holder is not tightly installed. Tighten screw.

Cutting small letters

When cutting small letters, cutting speed and force should be adjusted to the lowest setting. Similarly cutter tip should be adjusted to as short as possible.

Cutting large letters

Cutting speed and force may be increased to higher settings. When cutting large letters Sharp Angle in Artcut software may be ignored.