

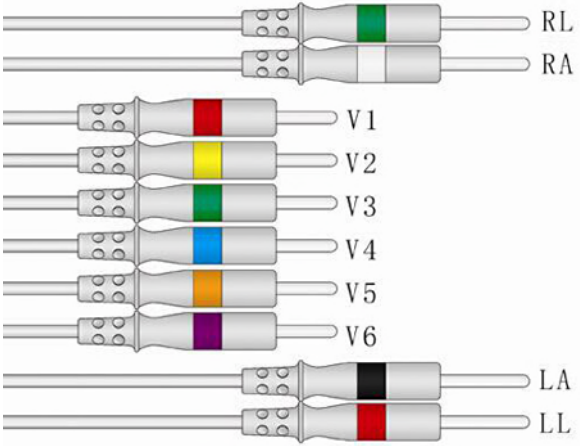

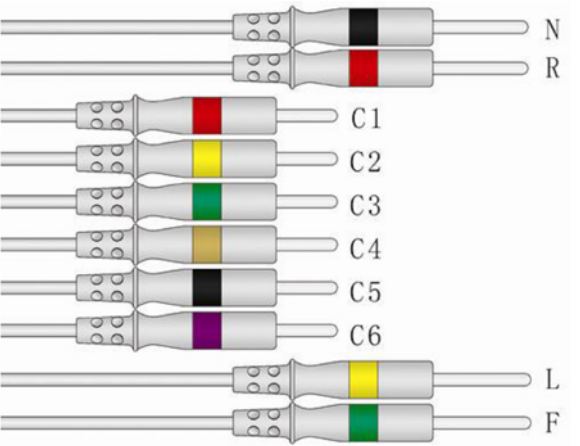

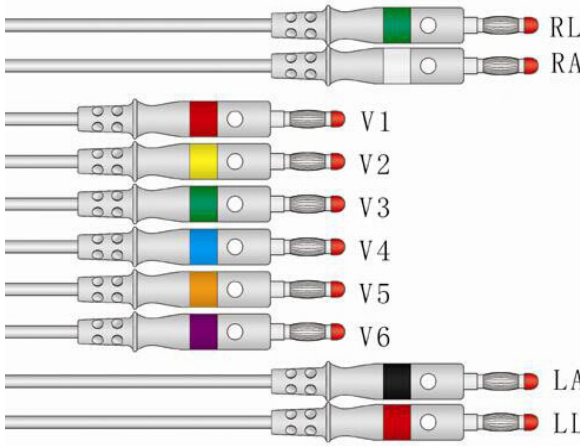

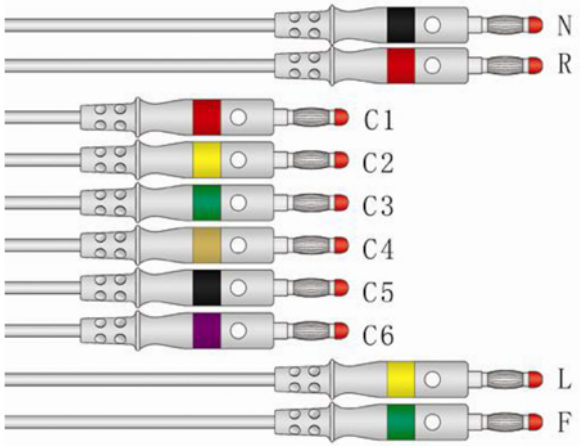
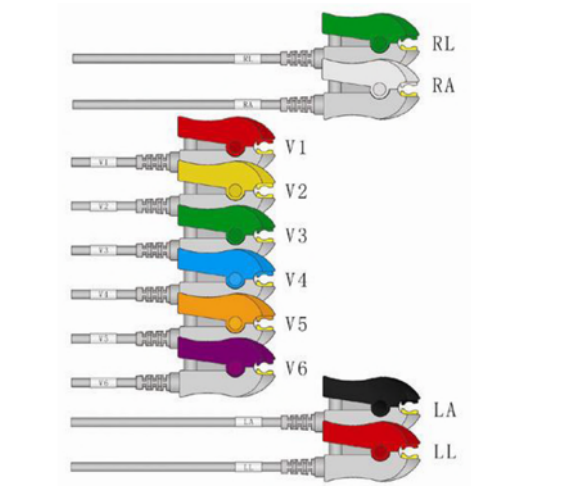
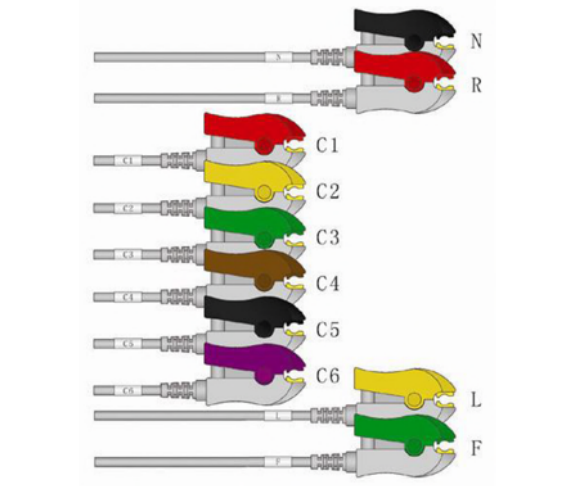
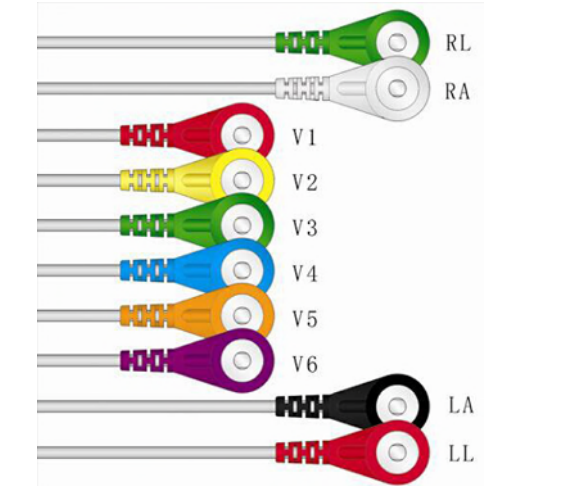
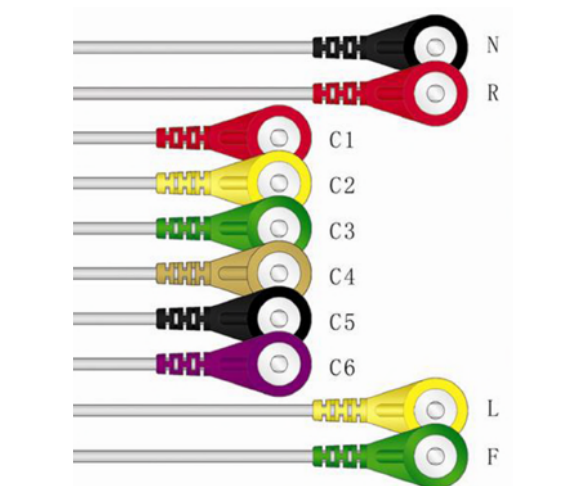
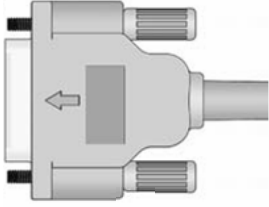
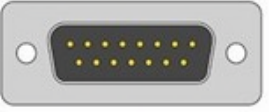
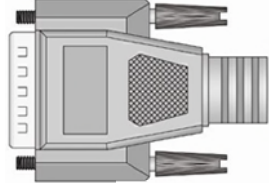
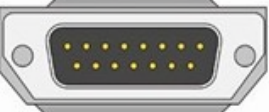
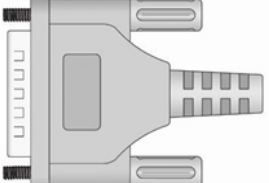
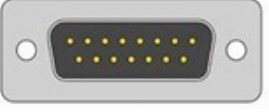
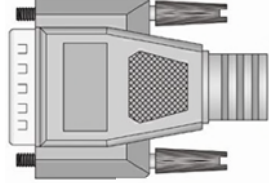
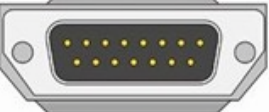
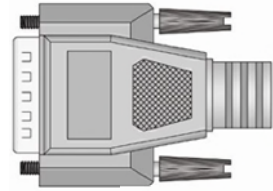
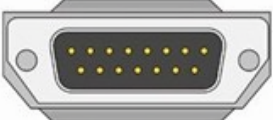
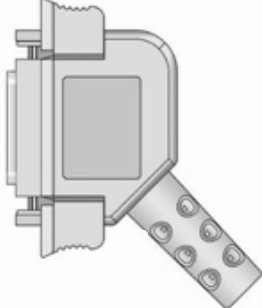

One piece 10 lead EKG Cable

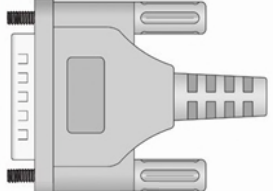
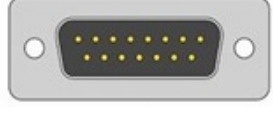
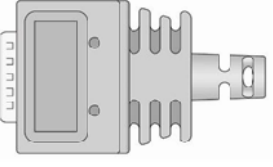

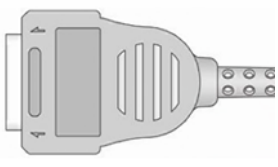
Code	AHA	IEC
Din 3.0mm	 <p>Diagram showing 10 leads with AHA Din 3.0mm connectors. Leads are labeled: RL (green), RA (white), V1 (red), V2 (yellow), V3 (green), V4 (blue), V5 (orange), V6 (purple), LA (black), and LL (red).</p>	 <p>Diagram showing 10 leads with IEC Din 3.0mm connectors. Leads are labeled: N (black), R (red), C1 (red), C2 (yellow), C3 (green), C4 (gold), C5 (black), C6 (purple), L (yellow), and F (green).</p>
Banana 4.0mm	 <p>Diagram showing 10 leads with AHA Banana 4.0mm connectors. Leads are labeled: RL (green), RA (white), V1 (red), V2 (yellow), V3 (green), V4 (blue), V5 (orange), V6 (purple), LA (black), and LL (red).</p>	 <p>Diagram showing 10 leads with IEC Banana 4.0mm connectors. Leads are labeled: N (black), R (red), C1 (red), C2 (yellow), C3 (green), C4 (gold), C5 (black), C6 (purple), L (yellow), and F (green).</p>
Clip	 <p>Diagram showing 10 leads with AHA Clip connectors. Leads are labeled: RL (green), RA (white), V1 (red), V2 (yellow), V3 (green), V4 (blue), V5 (orange), V6 (purple), LA (black), and LL (red).</p>	 <p>Diagram showing 10 leads with IEC Clip connectors. Leads are labeled: N (black), R (red), C1 (red), C2 (yellow), C3 (green), C4 (gold), C5 (black), C6 (purple), L (yellow), and F (green).</p>
Snap	 <p>Diagram showing 10 leads with AHA Snap connectors. Leads are labeled: RL (green), RA (white), V1 (red), V2 (yellow), V3 (green), V4 (blue), V5 (orange), V6 (purple), LA (black), and LL (red).</p>	 <p>Diagram showing 10 leads with IEC Snap connectors. Leads are labeled: N (black), R (red), C1 (red), C2 (yellow), C3 (green), C4 (gold), C5 (black), C6 (purple), L (yellow), and F (green).</p>

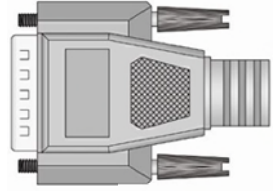
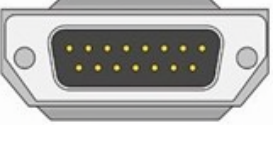

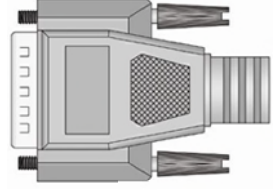
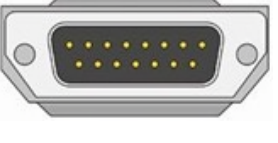

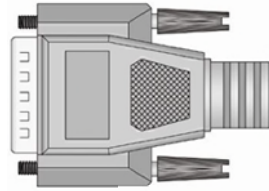
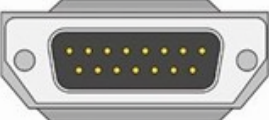
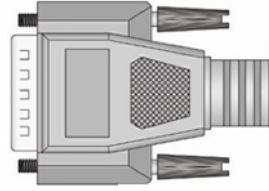
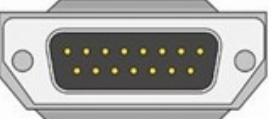
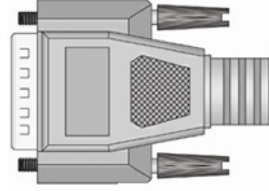
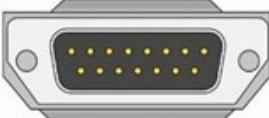
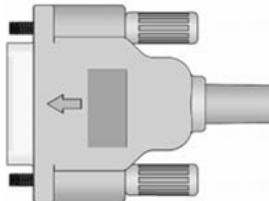
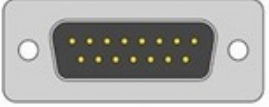

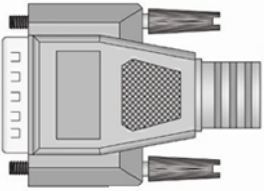
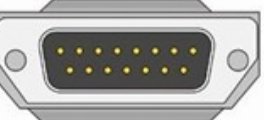
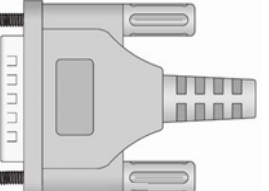
Brand	OEM NO	P/N	Description			Compatibility	Connector Imagine		
Aspel		MPK002A	IEC	Din3.0	20K resistance	AsCARD 3 (1992-93) Serie AsCARD AsCARD Mr Koral			
		MPK002B	AHA	Din3.0	20K resistance				
		MPK002C	IEC	Banana	20K resistance				
		MPK002D	AHA	Banana	20K resistance				
		MPK002E	IEC	Snap	20K resistance				
		MPK002F	AHA	Snap	20K resistance				
		MPK002G	IEC	Clip	20K resistance				
		MPK002H	AHA	Clip	20K resistance				
Biocare		MPK005A	IEC	Din3.0	No resistance	ECG101, 101G, 300, 300G, 9801, 9803, 9803G, 1200, 3010,3030, 6010, 1210, 1216, 1230 (solo/only conn. Dsub15: no 1215, iE15, iE12, ECG- 2000)			
		MPK005B	AHA	Din3.0	No resistance				
		MPK005C	IEC	Banana	No resistance				
		MPK005D	AHA	Banana	No resistance				
		MPK005E	IEC	Snap	No resistance				
		MPK005F	AHA	Snap	No resistance				
		MPK005G	IEC	Clip	No resistance				
		MPK005H	AHA	Clip	No resistance				
Bionet		MPK001A	IEC	Din3.0	10 k resistance	cardiocare 2000, cardiotouch 3000, cardio7			
		MPK001B	AHA	Din3.0	10 k resistance				
		MPK001C	IEC	Banana	10 k resistance				
		MPK001D	AHA	Banana	10 k resistance				
		MPK001E	IEC	Snap	10 k resistance				
		MPK001F	AHA	Snap	10 k resistance				
		MPK001G	IEC	Clip	10 k resistance				
		MPK001H	AHA	Clip	10 k resistance				
Biolight		MPK014A	IEC	Din3.0	No resistance	BLT-1203, BLT E12A, BLT E12, E70, E80 (solo/only conn. Dsub15)			
		MPK014B	AHA	Din3.0	No resistance				
		MPK014C	IEC	Banana	No resistance				
		MPK014D	AHA	Banana	No resistance				
		MPK014E	IEC	Snap	No resistance				
		MPK014F	AHA	Snap	No resistance				
		MPK014G	IEC	Clip	No resistance				
		MPK014H	AHA	Clip	No resistance				

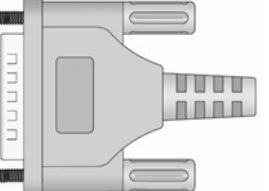
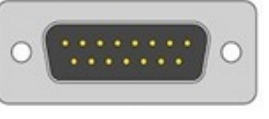
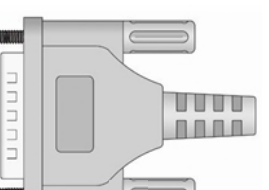
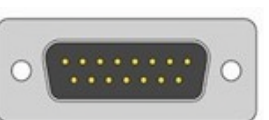
Brand	OEM NO	P/N	Description			Compatibility	Connector Imagine	
Bosch		MPK017A	IEC	Din3.0	4.7K resistance	EKG 601	 	
		MPK017B	AHA	Din3.0	4.7K resistance			
		MPK017C	IEC	Banana	4.7Kresistance			
		MPK017D	AHA	Banana	4.7K resistance			
		MPK017E	IEC	Snap	4.7K resistance			
		MPK017F	AHA	Snap	4.7K resistance			
		MPK017G	IEC	Clip	4.7K resistance			
		MPK017H	AHA	Clip	4.7K resistance			
Bosch		MPK015A	IEC	Din3.0	4.7 k resistance	603D, 603ER, 603S, 606	 	
		MPK015B	AHA	Din3.0	4.7 k resistance			
		MPK015C	IEC	Banana	4.7 k resistance			
		MPK015D	AHA	Banana	4.7 k resistance			
		MPK015E	IEC	Snap	4.7 k resistance			
		MPK015F	AHA	Snap	4.7 k resistance			
		MPK015G	IEC	Clip	4.7 k resistance			
		MPK015H	AHA	Clip	4.7 k resistance			
BTL		MPK001A	IEC	Din3.0	10 k resistance	Serie BTL-08	 	
		MPK001B	AHA	Din3.0	10 k resistance			
		MPK001C	IEC	Banana	10 k resistance			
		MPK001D	AHA	Banana	10 k resistance			
		MPK001E	IEC	Snap	10 k resistance			
		MPK001F	AHA	Snap	10 k resistance			
		MPK001G	IEC	Clip	10 k resistance			
		MPK001H	AHA	Clip	10 k resistance			
Burdick		MPK008A	IEC	Din3.0	No resistance	EK-10-E350	 	
		MPK008B	AHA	Din3.0	No resistance			
		MPK008C	IEC	Banana	No resistance			
	012-0700-00	MPK008D	AHA	Banana	No resistance			
		MPK008E	IEC	Snap	No resistance			
		MPK008F	AHA	Snap	No resistance			
		MPK008G	IEC	Clip	No resistance			
		MPK008H	AHA	Clip	No resistance			

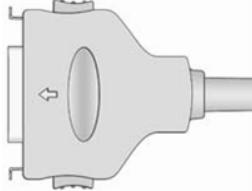

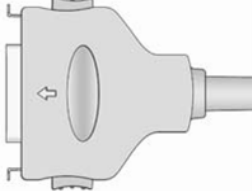

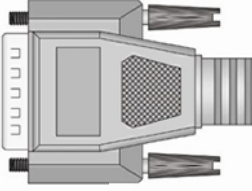
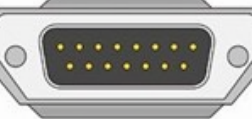
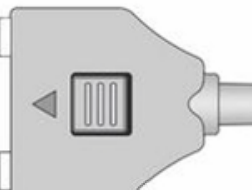

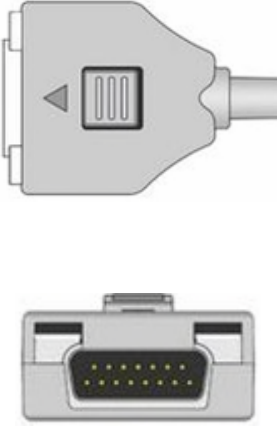
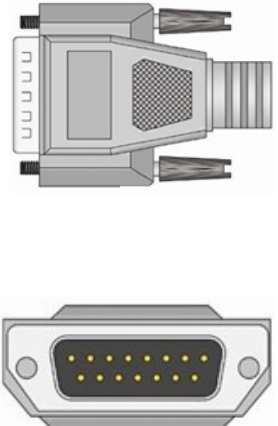
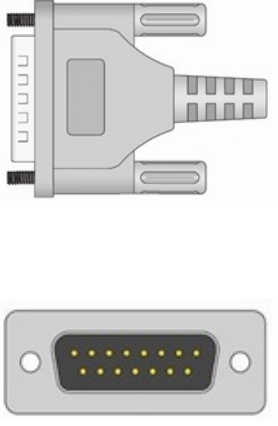
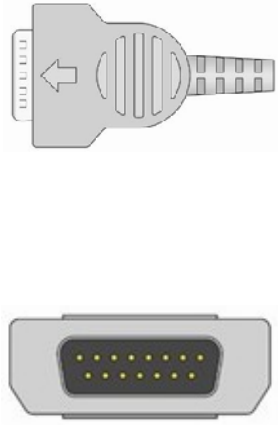

Brand	OEM NO	P/N	Description				Compatibility	Connector Imagine	
Burdick Quinton		MPK016A	IEC	Din3.0	10 k	resistance	Burdick Quinton Eclipse 4,8,400,800, 850,850i,plus, Eclipse LE II and ATRIA PLUS,ATRIA3000	 	
		MPK016B	AHA	Din3.0	10 k	resistance			
		MPK016C	IEC	Banana	10 k	resistance			
		MPK016D	AHA	Banana	10 k	resistance			
		MPK016E	IEC	Snap	10 k	resistance			
		MPK016F	AHA	Snap	10 k	resistance			
		MPK016G	IEC	Clip	10 k	resistance			
		MPK016H	AHA	Clip	10 k	resistance			
Burdick		MPK017A	IEC	Din3.0	4.7 k	resistance	Burdick: EK-10, Elite, Elite II, E-350,E350i, E550, E560, (1st Generation Eclipse LE/LEi, with serial number starting with 1051). Burdick #007705, Stress cable with detachable leads007706	 	
		MPK017B	AHA	Din3.0	4.7k	resistance			
		MPK017C	IEC	Banana	4.7k	resistance			
		MPK017D	AHA	Banana	4.7k	resistance			
		MPK017E	IEC	Snap	4.7k	resistance			
		MPK017F	AHA	Snap	4.7k	resistance			
		MPK017G	IEC	Clip	4.7k	resistance			
		MPK017H	AHA	Clip	4.7k	resistance			
Burdick Quinton		MPK018A	IEC	Din3.0	10 k	resistance	Burdick Q-Stress Treadmill System	 	
		MPK018B	AHA	Din3.0	10 k	resistance			
		MPK018C	IEC	Banana	10 k	resistance			
		MPK018D	AHA	Banana	10 k	resistance			
		MPK018E	IEC	Snap	10 k	resistance			
		MPK018F	AHA	Snap	10 k	resistance			
		MPK018G	IEC	Clip	10 k	resistance			
		MPK018H	AHA	Clip	10 k	resistance			
Carewell		MPK014A	IEC	Din3.0	No	resistance	tutti i modelli / all models stand-alone	 	
		MPK014B	AHA	Din3.0	No	resistance			
		MPK014C	IEC	Banana	No	resistance			
		MPK014D	AHA	Banana	No	resistance			
		MPK014E	IEC	Snap	No	resistance			
		MPK014F	AHA	Snap	No	resistance			
		MPK014G	IEC	Clip	No	resistance			
		MPK014H	AHA	Clip	No	resistance			



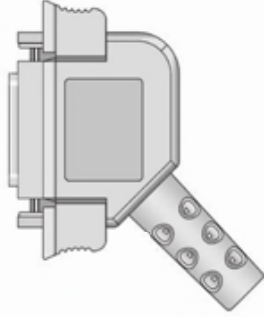

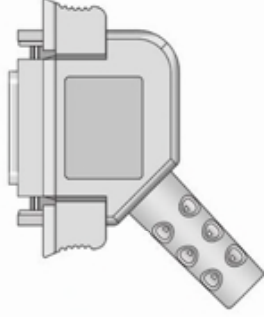
Brand	OEM NO	P/N	Description			Compatibility	Connector Imagine		
Cardioline		MPK005A	IEC	Din3.0	No resistance	AR600,1200, 2100 all versions;E1.E1 R . E3 , Delta 1, 300, 360, C3 .			
		MPK005B	AHA	Din3.0	No resistance				
		MPK005C	IEC	Banana	No resistance				
		MPK005D	AHA	Banana	No resistance				
		MPK005E	IEC	Snap	No resistance				
		MPK005F	AHA	Snap	No resistance				
		MPK005G	IEC	Clip	No resistance				
		MPK005H	AHA	Clip	No resistance				
Comen		MPK014A	IEC	Din3.0	No resistance	CM100, 300, 600, 1200, 1200A, 1200B			
		MPK014B	AHA	Din3.0	No resistance				
		MPK014C	IEC	Banana	No resistance				
		MPK014D	AHA	Banana	No resistance				
		MPK014E	IEC	Snap	No resistance				
		MPK014F	AHA	Snap	No resistance				
		MPK014G	IEC	Clip	No resistance				
		MPK014H	AHA	Clip	No resistance				
Contec		MPK014A	IEC	Din3.0	No resistance	Contec All			
		MPK014B	AHA	Din3.0	No resistance				
		MPK014C	IEC	Banana	No resistance				
		MPK014D	AHA	Banana	No resistance				
		MPK014E	IEC	Snap	No resistance				
		MPK014F	AHA	Snap	No resistance				
		MPK014G	IEC	Clip	No resistance				
		MPK014H	AHA	Clip	No resistance				
Dr. Lee		MPK002A	IEC	Din3.0	20 k resistance	ECG-120A, 320A, 320B			
		MPK002B	AHA	Din3.0	20 k resistance				
		MPK002C	IEC	Banana	20 k resistance				
		MPK002D	AHA	Banana	20 k resistance				
		MPK002E	IEC	Snap	20 k resistance				
		MPK002F	AHA	Snap	20 k resistance				
		MPK002G	IEC	Clip	20 k resistance				
		MPK002H	AHA	Clip	20 k resistance				

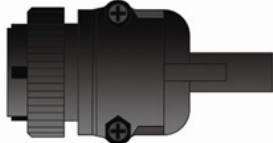

Brand	OEM NO	P/N	Description			Compatibility	Connector Imagine		
DongJiang		MPK005A	IEC	Din3.0	No resistance	ECG-11A, 11B, 11D, 32A,32A(II,) 120			
		MPK005B	AHA	Din3.0	No resistance				
		MPK005C	IEC	Banana	No resistance				
		MPK005D	AHA	Banana	No resistance				
		MPK005E	IEC	Snap	No resistance				
		MPK005F	AHA	Snap	No resistance				
		MPK005G	IEC	Clip	No resistance				
		MPK005H	AHA	Clip	No resistance				
Ecafix		MPK019A	IEC	Din3.0	51K resistance	Ecafix			
		MPK019B	AHA	Din3.0	51K resistance				
		MPK019C	IEC	Banana	51K resistance				
		MPK019D	AHA	Banana	51K resistance				
		MPK019E	IEC	Snap	51K resistance				
		MPK019F	AHA	Snap	51K resistance				
		MPK019G	IEC	Clip	51K resistance				
		MPK019H	AHA	Clip	51K resistance				
Edan		MPK001A	IEC	Din3.0	10 k resistance	SE-1010, SE-1212			
		MPK001B	AHA	Din3.0	10 k resistance				
		MPK001C	IEC	Banana	10 k resistance				
		MPK001D	AHA	Banana	10 k resistance				
		MPK001E	IEC	Snap	10 k resistance				
		MPK001F	AHA	Snap	10 k resistance				
		MPK001G	IEC	Clip	10 k resistance				
		MPK001H	AHA	Clip	10 k resistance				
Esaote		MPK001A	IEC	Din3.0	10 k resistance	P80, P80six, P80power.P8000, P8000power			
		MPK001B	AHA	Din3.0	10 k resistance				
		MPK001C	IEC	Banana	10 k resistance				
		MPK001D	AHA	Banana	10 k resistance				
		MPK001E	IEC	Snap	10 k resistance				
		MPK001F	AHA	Snap	10 k resistance				
		MPK001G	IEC	Clip	10 k resistance				
		MPK001H	AHA	Clip	10 k resistance				

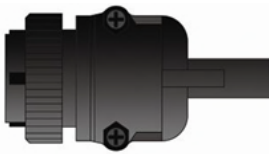

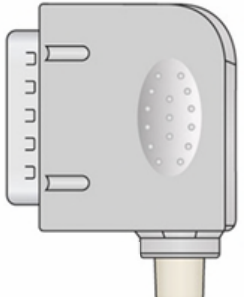
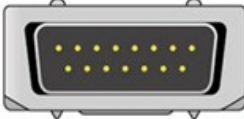
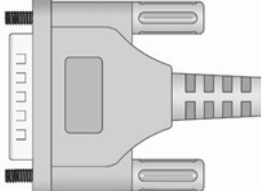
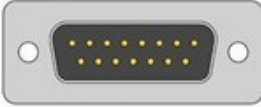
Brand	OEM NO	P/N	Description			Compatibility	Connector Imagine		
Fukuda Denshi		MPK009A	IEC	Din3.0	No resistance	FX101, FX102F, FX328U, FCP2201			
		MPK009B	AHA	Din3.0	No resistance				
		MPK009C	IEC	Banana	No resistance				
		MPK009D	AHA	Banana	No resistance				
		MPK009E	IEC	Snap	No resistance				
		MPK009F	AHA	Snap	No resistance				
		MPK009G	IEC	Clip	No resistance				
		MPK009H	AHA	Clip	No resistance				
Fukuda Denshi		MPK020A	IEC	Din3.0	4.7k resistance	Autocardiner, Cardimax FX- 2111 FX-3010 FX-4010 FCP-2155			
		MPK020B	AHA	Din3.0	4.7k resistance				
		MPK020C	IEC	Banana	4.7k resistance				
		MPK020D	AHA	Banana	4.7k resistance				
		MPK020E	IEC	Snap	4.7k resistance				
		MPK020F	AHA	Snap	4.7k resistance				
		MPK020G	IEC	Clip	4.7k resistance				
		MPK020H	AHA	Clip	4.7k resistance				
Fukuda Denshi		MPK017A	IEC	Din3.0	4.7k resistance	Fukuda Denshi: Alpha 500 / 600, FCP 2201			
		MPK017B	AHA	Din3.0	4.7k resistance				
		MPK017C	IEC	Banana	4.7k resistance				
		MPK017D	AHA	Banana	4.7k resistance				
		MPK017E	IEC	Snap	4.7k resistance				
		MPK017F	AHA	Snap	4.7k resistance				
		MPK017G	IEC	Clip	4.7k resistance				
		MPK017H	AHA	Clip	4.7k resistance				
Fukuda ME		MPK021A	IEC	Din3.0	No resistance	KP-500			
		MPK021B	AHA	Din3.0	No resistance				
		MPK021C	IEC	Banana	No resistance				
		MPK021D	AHA	Banana	No resistance				
		MPK021E	IEC	Snap	No resistance				
		MPK021F	AHA	Snap	No resistance				
		MPK021G	IEC	Clip	No resistance				
		MPK021H	AHA	Clip	No resistance				



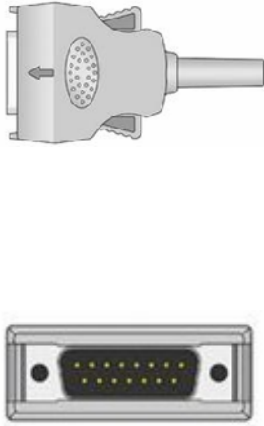

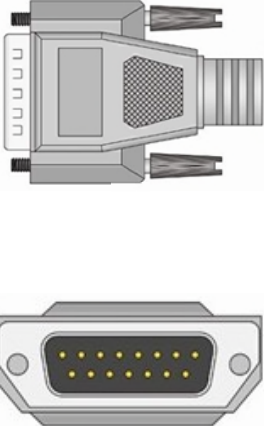

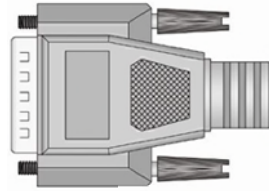
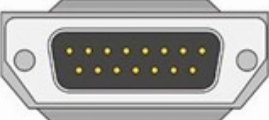
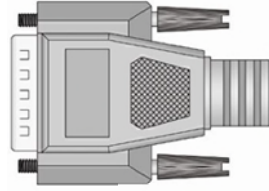
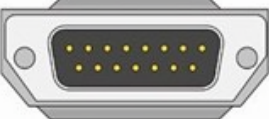
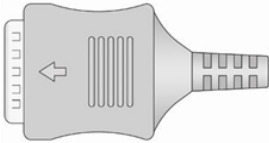
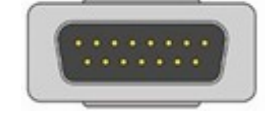
Brand	OEM NO	P/N	Description				Compatibility	Connector Imagine	
Fukuda ME		MPK022A	IEC	Din3.0	20 k	resistance	KP-500D		
		MPK022B	AHA	Din3.0	20 k	resistance			
		MPK022C	IEC	Banana	20 k	resistance			
		MPK022D	AHA	Banana	20 k	resistance			
		MPK022E	IEC	Snap	20 k	resistance			
		MPK022F	AHA	Snap	20 k	resistance			
		MPK022G	IEC	Clip	20 k	resistance			
		MPK022H	AHA	Clip	20 k	resistance			
Fukuda ME		MPK017A	IEC	Din3.0	4.7 k	resistance	Fukuda ME: Cardisuny alpha 4.700, Cardisuny alpha 6600 A / 6600 AX		
		MPK017B	AHA	Din3.0	4.7 k	resistance			
		MPK017C	IEC	Banana	4.7 k	resistance			
		MPK017D	AHA	Banana	4.7 k	resistance			
		MPK017E	IEC	Snap	4.7 k	resistance			
		MPK017F	AHA	Snap	4.7 k	resistance			
		MPK017G	IEC	Clip	4.7 k	resistance			
		MPK017H	AHA	Clip	4.7 k	resistance			
Innomed		MPK001A	IEC	Din3.0	10 k	resistance	MAC 500, MAC 1100, MAC 1200		
		MPK001B	AHA	Din3.0	10 k	resistance			
		MPK001C	IEC	Banana	10 k	resistance			
		MPK001D	AHA	Banana	10 k	resistance			
		MPK001E	IEC	Snap	10 k	resistance			
		MPK001F	AHA	Snap	10 k	resistance			
		MPK001G	IEC	Clip	10 k	resistance			
		MPK001H	AHA	Clip	10 k	resistance			
GE-Marquette		MPK010A	IEC	Din3.0	10 k	resistance	MicroSmart MAC 500 / 1100 MAC 1200 / 1200 ST		
		MPK010B	AHA	Din3.0	10 k	resistance			
	2029890-001	MPK010C	IEC	Banana	10 k	resistance			
	2029893-001	MPK010D	AHA	Banana	10 k	resistance			
		MPK010E	IEC	Snap	10 k	resistance			
		MPK010F	AHA	Snap	10 k	resistance			
		MPK010G	IEC	Clip	10 k	resistance			
		MPK010H	AHA	Clip	10 k	resistance			





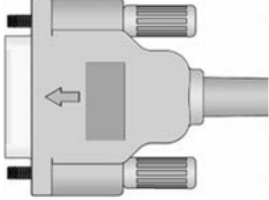
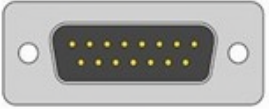

Brand	OEM NO	P/N	Description				Compatibility	Connector Imagine	
GE-Marquette		MPK023A	IEC	Din3.0	10 k	resistance	GE Eagle, Solar, Dash , Tram, MAC-Lab Cath Lab System, Datex-Ohmeda S/5 FM	 	
		MPK023B	AHA	Din3.0	10 k	resistance			
		MPK023C	IEC	Banana	10 k	resistance			
		MPK023D	AHA	Banana	10 k	resistance			
		MPK023E	IEC	Snap	10 k	resistance			
		MPK023F	AHA	Snap	10 k	resistance			
		MPK023G	IEC	Clip	10 k	resistance			
		MPK023H	AHA	Clip	10 k	resistance			
Hellige / Siemens H mann / Bosch		MPK024A	IEC	Din3.0	No	resistance	Hellige:EK 36, EK 41, EK 43, EK 53,EK 56, EK 403, EK 413, EK 512, EK 512 E,EK 512 P, Cardiosmart, CardioSys, Corna;Siemens: Cardiostat 1/3T/703/710,Cardina C,Cardirex 3T/4/6T/62,Cathcor,Megacard Elema A/B, R, R/E,Mingodoc, Mingocard 3 / 4 / 7, Mingograph 4 / 62 / 81,Mingograph 82 / 740, Mingolog7,Mira card 1,Sirecard440/440S/460/460S/740,Sireg, Sirecard 803, Sirecust 701;Custo-med: Custo-card Bosch:603 D,	 	
		MPK024B	AHA	Din3.0	No	resistance			
		MPK024C	IEC	Banana	No	resistance			
		MPK024D	AHA	Banana	No	resistance			
		MPK024E	IEC	Snap	No	resistance			
		MPK024F	AHA	Snap	No	resistance			
		MPK024G	IEC	Clip	No	resistance			
		MPK024H	AHA	Clip	No	resistance			
Hellige / Siemens Hörmann / Bosch		MPK015A	IEC	Din3.0	4.7k	resistance	Hellige:EK 36, EK 41, EK 43, EK 53,EK 56, EK 403, EK 413, EK 512, EK 512 E,EK 512 P, Cardiosmart, CardioSys, Corna;Siemens: Cardiostat 1/3T/703/710,Cardina C,Cardirex 3T/4/6T/62,Cathcor,Megacard Elema A/B, R, R/E,Mingodoc, Mingocard 3 / 4 / 7, Mingograph 4 / 62 / 81,Mingograph 82 / 740, Mingolog7,Mira card 1,Sirecard440/440S/460/460S/740,Sireg, Sirecard 803, Sirecust 701;Custo-med: Custo-card Bosch:603 D,	 	
		MPK015B	AHA	Din3.0	4.7k	resistance			
		MPK015C	IEC	Banana	4.7k	resistance			
		MPK015D	AHA	Banana	4.7k	resistance			
		MPK015E	IEC	Snap	4.7k	resistance			
		MPK015F	AHA	Snap	4.7k	resistance			
		MPK015G	IEC	Clip	4.7k	resistance			
		MPK015H	AHA	Clip	4.7k	resistance			
Kanz		MPK003A	IEC	Din3.0	No	resistance	Delta 3, Delta 30, Delta 60, Delta 1 plus, Delta 3 plus, Delta 60 plus	 	
		MPK003B	AHA	Din3.0	No	resistance			
		MPK003C	IEC	Banana	No	resistance			
		MPK003D	AHA	Banana	No	resistance			
		MPK003E	IEC	Snap	No	resistance			
		MPK003F	AHA	Snap	No	resistance			
		MPK003G	IEC	Clip	No	resistance			
		MPK003H	AHA	Clip	No	resistance			

Brand	OEM NO	P/N	Description				Compatibility	Connector Imagine	
Kanz	PC-104	MPK025A	IEC	Din3.0	4.7k	resistance	Delta 3, Delta 30, Delta 60, Delta 1 plus, Delta 3 plus, Delta 60 plus	 	
		MPK025B	AHA	Din3.0	4.7k	resistance			
		MPK025C	IEC	Banana	4.7k	resistance			
		MPK025D	AHA	Banana	4.7k	resistance			
		MPK025E	IEC	Snap	4.7k	resistance			
		MPK025F	AHA	Snap	4.7k	resistance			
		MPK025G	IEC	Clip	4.7k	resistance			
		MPK025H	AHA	Clip	4.7k	resistance			
Kanz	PC-109	MPK004A	IEC	Din3.0	No	resistance	ECG 108/110/1203, 1205, Cardico 302/601/1210/1211	 	
		MPK004B	AHA	Din3.0	No	resistance			
		MPK004C	IEC	Banana	No	resistance			
		MPK004D	AHA	Banana	No	resistance			
		MPK004E	IEC	Snap	No	resistance			
		MPK004F	AHA	Snap	No	resistance			
		MPK004G	IEC	Clip	No	resistance			
		MPK004H	AHA	Clip	No	resistance			
Kontron		MPK001A	IEC	Din3.0	10 k	resistance	EKG P80	 	
		MPK001B	AHA	Din3.0	10 k	resistance			
		MPK001C	IEC	Banana	10 k	resistance			
		MPK001D	AHA	Banana	10 k	resistance			
		MPK001E	IEC	Snap	10 k	resistance			
		MPK001F	AHA	Snap	10 k	resistance			
		MPK001G	IEC	Clip	10 k	resistance			
		MPK001H	AHA	Clip	10 k	resistance			
Medtronic Physio Contro		MPK026A	IEC	Din3.0	10 k	resistance	Lifepak 12	 	
		MPK026B	AHA	Din3.0	10 k	resistance			
		MPK026C	IEC	Banana	10 k	resistance			
		MPK026D	AHA	Banana	10 k	resistance			
		MPK026E	IEC	Snap	10 k	resistance			
		MPK026F	AHA	Snap	10 k	resistance			
		MPK026G	IEC	Clip	10 k	resistance			
		MPK026H	AHA	Clip	10 k	resistance			

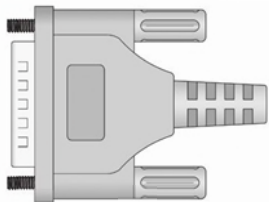
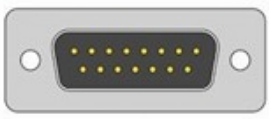
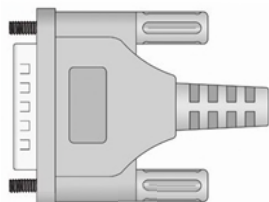
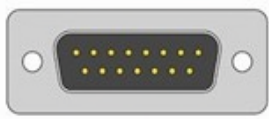
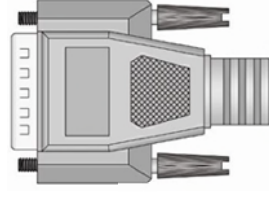
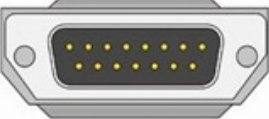
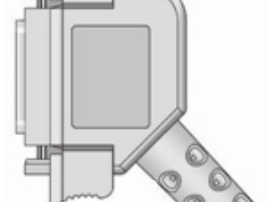
Brand	OEM NO	P/N	Description				Compatibility	Connector Imagine	
Mindray		MPK027A	IEC	Din3.0	10 k	resistance	Mindray		
		MPK027B	AHA	Din3.0	10 k	resistance			
		MPK027C	IEC	Banana	10 k	resistance			
		MPK027D	AHA	Banana	10 k	resistance			
		MPK027E	IEC	Snap	10 k	resistance			
		MPK027F	AHA	Snap	10 k	resistance			
		MPK027G	IEC	Clip	10 k	resistance			
		MPK027H	AHA	Clip	10 k	resistance			
Mortara		MPK028A	IEC	Din3.0	4.7k	resistance	ELI-100、ELI-200、ELI-50		
		MPK028B	AHA	Din3.0	4.7k	resistance			
		MPK028C	IEC	Banana	4.7k	resistance			
		MPK028D	AHA	Banana	4.7k	resistance			
		MPK028E	IEC	Snap	4.7k	resistance			
		MPK028F	AHA	Snap	4.7k	resistance			
		MPK028G	IEC	Clip	4.7k	resistance			
		MPK028H	AHA	Clip	4.7k	resistance			
NEC		MPK011A	IEC	Din3.0	10 k	resistance	YY-1063		
		MPK011B	AHA	Din3.0	10 k	resistance			
		MPK011C	IEC	Banana	10 k	resistance			
		MPK011D	AHA	Banana	10 k	resistance			
		MPK011E	IEC	Snap	10 k	resistance			
		MPK011F	AHA	Snap	10 k	resistance			
		MPK011G	IEC	Clip	10 k	resistance			
		MPK011H	AHA	Clip	10 k	resistance			
Nihon Kohden	BJ-901D	MPK005A	IEC	Din3.0	No	resistance	Cardio Fax Q ECG-9110K ECG-9130K Doing Juang Cardioline (New)		
	BA-901D	MPK005B	AHA	Din3.0	No	resistance			
	BJ-902D	MPK005C	IEC	Banana	No	resistance			
	BA-902D	MPK005D	AHA	Banana	No	resistance			
		MPK005E	IEC	Snap	No	resistance			
		MPK005F	AHA	Snap	No	resistance			
	BJ-903D	MPK005G	IEC	Clip	No	resistance			
	BA-903D	MPK005H	AHA	Clip	No	resistance			

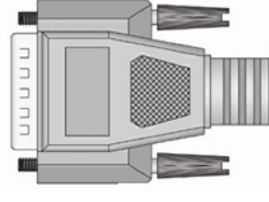
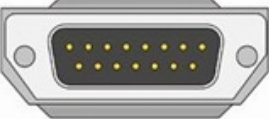
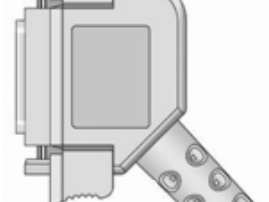

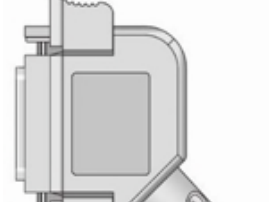

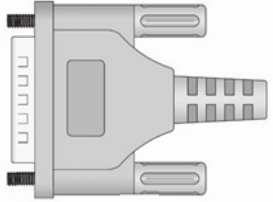
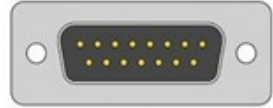
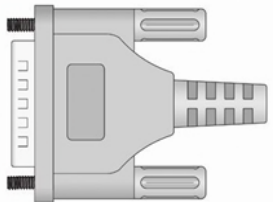
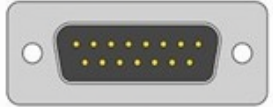

Brand	OEM NO	P/N	Description				Compatibility	Connector Imagine		
Nihon Kohden		MPK017A	IEC	Din3.0	4.7k	resistance	Nihon Kohden: Cardiofax6151/ 6353,Cardiofax EKG- 8270/8350/8370 /8420 8423/8450/8453 /8820/8823/883 0/9130 Cardiofax- Q;Bosch/dimeq: 501A,501NV,50 3,601,503B,503 D,503NV,503V, 506,506D,Camb ridge: VS 6,SC 1000,Cardioline: E1,1 R/3,DELTA 3/300/360,Cardi onics:all Models,Hellige: Corina.EK 51,Honeywell/P hilips:Cardiopl n,CR 300,CR 330,ER330,Poly med:Alpha 600/800,Schwar zer:VS 6,SECA:3000			
		MPK017B	AHA	Din3.0	4.7k	resistance				
		MPK017C	IEC	Banana	4.7k	resistance				
		MPK017D	AHA	Banana	4.7k	resistance				
		MPK017E	IEC	Snap	4.7k	resistance				
		MPK017F	AHA	Snap	4.7k	resistance				
		MPK017G	IEC	Clip	4.7k	resistance				
		MPK017H	AHA	Clip	4.7k	resistance				
Nihon Kohden		MPK017A	IEC	Din3.0	4.7k	resistance	Nihon Kohden: Cardiofax6151/ 6353,Cardiofax EKG- 8270/8350/8370 /8420 8423/8450/8453 /8820/8823/883 0/9130 Cardiofax- Q;Bosch/dimeq: 501A,501NV,50 3,601,503B,503 D,503NV,503V, 506,506D,Camb ridge: VS 6,SC 1000,Cardioline: E1,1 R/3,DELTA 3/300/360,Cardi onics:all Models,Hellige: Corina.EK 51,Honeywell/P hilips:Cardiopl n,CR 300,CR 330,ER330,Poly med:Alpha 600/800,Schwar zer:VS 6,SECA:3000			
		MPK017B	AHA	Din3.0	4.7k	resistance				
		MPK017C	IEC	Banana	4.7k	resistance				
		MPK017D	AHA	Banana	4.7k	resistance				
		MPK017E	IEC	Snap	4.7k	resistance				
		MPK017F	AHA	Snap	4.7k	resistance				
		MPK017G	IEC	Clip	4.7k	resistance				
		MPK017H	AHA	Clip	4.7k	resistance				
Nihon Kohden (Shanghai Konden)		MPK006A	IEC	Din3.0	No	resistance	Cardio Fax 6151,6851,6353 CadioFax 8110,			
		MPK006B	AHA	Din3.0	No	resistance				
	BD-615E	MPK006C	IEC	Banana	No	resistance				
		MPK006D	AHA	Banana	No	resistance				
		MPK006E	IEC	Snap	No	resistance				
		MPK006F	AHA	Snap	No	resistance				
		MPK006G	IEC	Clip	No	resistance				
		MPK006H	AHA	Clip	No	resistance				
Nihon Kohden	BR-912D	MPK029A	IEC	Din3.0	20 k	resistance	ECG-9320/ ECG-9522P (Original part No.: BR-911D)			
		MPK029B	AHA	Din3.0	20 k	resistance				
		MPK029C	IEC	Banana	20 k	resistance				
		MPK029D	AHA	Banana	20 k	resistance				
		MPK029E	IEC	Snap	20 k	resistance				
		MPK029F	AHA	Snap	20 k	resistance				
		MPK029G	IEC	Clip	20 k	resistance				
		MPK029H	AHA	Clip	20 k	resistance				

Brand	OEM NO	P/N	Description			Compatibility	Connector Imagine	
Nihon Kohden		MPK033A	IEC	Din3.0	No resistance	BSM-2301, BSM-2353, BSM-5100,	 	
		MPK033B	AHA	Din3.0	No resistance			
		MPK033C	IEC	Banana	No resistance			
		MPK033D	AHA	Banana	No resistance			
		MPK033E	IEC	Snap	No resistance			
		MPK033F	AHA	Snap	No resistance			
		MPK033G	IEC	Clip	No resistance			
		MPK033H	AHA	Clip	No resistance			
Petas		MPK030A	IEC	Din3.0	No resistance	Petas KardioPET 300,500	 	
		MPK030B	AHA	Din3.0	No resistance			
		MPK030C	IEC	Banana	No resistance			
		MPK030D	AHA	Banana	No resistance			
		MPK030E	IEC	Snap	No resistance			
		MPK030F	AHA	Snap	No resistance			
		MPK030G	IEC	Clip	Noresistance			
		MPK030H	AHA	Clip	No resistance			
Philips/ HP		MPK002A	IEC	Din3.0	20 k resistance	PageWriter 100, 200, 300 (M1770A, M1771A, M1772A)	 	
		MPK002B	AHA	Din3.0	20 k resistance			
	M3703C	MPK002C	IEC	Banana	20 k resistance			
	M3702C	MPK002D	AHA	Banana	20 k resistance			
		MPK002E	IEC	Snap	20 k resistance			
		MPK002F	AHA	Snap	20 k resistance			
		MPK002G	IEC	Clip	20 k resistance			
		MPK002H	AHA	Clip	20 k resistance			
Spacelabs		MPK032A	IEC	Din3.0	10 k resistance	90496 Ultraview Module	 	
		MPK032B	AHA	Din3.0	10 k resistance			
		MPK032C	IEC	Banana	10 k resistance			
		MPK032D	AHA	Banana	10 k resistance			
		MPK032E	IEC	Snap	10 k resistance			
		MPK032F	AHA	Snap	10 k resistance			
		MPK032G	IEC	Clip	10 k resistance			
		MPK032H	AHA	Clip	10 k resistance			



Brand	OEM NO	P/N	Description			Compatibility	Connector Imagine			
Schiller		MPK031A	IEC	Din3.0	No resistance	Schiller EKG? AT-1 , AT-2 , AT-3 , AT-5, AT-6, AT-10 , AT-60, AT-106 AT-102,CS-200 ,CARDIOVIT AT-10 plus ,AT- 104 PC,AT-110, CS100 ,cs 6,CS 6/12. AT- 4;Avionics(Del Mar):910/920/9 30/940/942 950/960/970/98 0 Custo-med: Custo-norm; Ergoline: Autoruler, Autoscript 6/12 Cardiette, EK 3003 / 3012, Ergoline; Fidelity: LP 3000; Reynolds: Cardiotrack 12 Trentina: All Excel-Types				
		MPK031B	AHA	Din3.0	No resistance					
		MPK031C	IEC	Banana	No resistance					
		MPK031D	AHA	Banana	No resistance					
		MPK031E	IEC	Snap	No resistance					
		MPK031F	AHA	Snap	No resistance					
		MPK031G	IEC	Clip	Noresistance					
		MPK031H	AHA	Clip	No resistance					
		MPK001A	IEC	Din3.0	10 k resistance					
		MPK001B	AHA	Din3.0	10 k resistance					
		MPK001C	IEC	Banana	10 k resistance					
		MPK001D	AHA	Banana	10 k resistance					
		MPK001E	IEC	Snap	10 k resistance					
		MPK001F	AHA	Snap	10 k resistance					
		MPK001G	IEC	Clip	10 k resistance					
		MPK001H	AHA	Clip	10 k resistance					
Trismed		MPK014A	IEC	Din3.0	No resistance	Cardipia, tutti i modelli / all models				
		MPK014B	AHA	Din3.0	No resistance					
		MPK014C	IEC	Banana	No resistance					
		MPK014D	AHA	Banana	No resistance					
		MPK014E	IEC	Snap	No resistance					
		MPK014F	AHA	Snap	No resistance					
		MPK014G	IEC	Clip	No resistance					
		MPK014H	AHA	Clip	No resistance					
Von Berg (Hormann)		MPK015A	IEC	Din3.0	4.7 k resistance	Bioset 3500, 3600, 3700, 6000, 8000				
		MPK015B	AHA	Din3.0	4.7 k resistance					
		MPK015C	IEC	Banana	4.7 k resistance					
		MPK015D	AHA	Banana	4.7 k resistance					
		MPK015E	IEC	Snap	4.7 k resistance					
		MPK015F	AHA	Snap	4.7 k resistance					
		MPK015G	IEC	Clip	4.7 k resistance					
		MPK015H	AHA	Clip	4.7 k resistance					





Brand	OEM NO	P/N	Description				Compatibility	Connector Imagine		
Von Berg (Hormann)		MPK001A	IEC	Din3.0	10 k	resistance	Bioset 9000			
		MPK001B	AHA	Din3.0	10 k	resistance				
		MPK001C	IEC	Banana	10 k	resistance				
		MPK001D	AHA	Banana	10 k	resistance				
		MPK001E	IEC	Snap	10 k	resistance				
		MPK001F	AHA	Snap	10 k	resistance				
		MPK001G	IEC	Clip	10 k	resistance				
		MPK001H	AHA	Clip	10 k	resistance				
Welch Allyn		MPK001A	IEC	Din3.0	10 k	resistance	CP10, 20, 50, 300. Serie AT. Serie SP. Serie CT.			
		MPK001B	AHA	Din3.0	10 k	resistance				
		MPK001C	IEC	Banana	10 k	resistance				
		MPK001D	AHA	Banana	10 k	resistance				
		MPK001E	IEC	Snap	10 k	resistance				
		MPK001F	AHA	Snap	10 k	resistance				
		MPK001G	IEC	Clip	10 k	resistance				
		MPK001H	AHA	Clip	10 k	resistance				

Suction Electrode

Brand	OEM No	Part No	Description	Image	
All Resting ECG Recommended for Nihon Konden, GE, Philips		MPK012A	Suction Electrode Perfect for Din3.0,6 pcs/set		
		MPK012B	Suction Electrode Perfect for Banana 4.0,6 pcs/set		
		MPK012C	Suction Electrode Perfect for Banana 4.0 and Din3.0,6 pcs/set		
All Resting ECG Recommended for GE-Marquette, Schiller, Mortala, Burdick, Philips		MPK012D	Adult Multi Purpose Suction Electrode Both for Banana 4.0, Din3.0,snap,Agcl,bulb diameter 26mm,6 pcs/set		
	40419A	MPK012E	Large Adult Multi Purpose Suction Electrode Both for Banana 4.0, Din3.0,snap,Agcl, bulb diameter 32mm-5cc		
	40422A	MPK012F	Pediatric Multi Purpose Suction Electrode Both for Banana 4.0, Din3.0,snap,Agcl,bulb diameter 23mm-2cc,6 pcs/set		

Limb Electrode

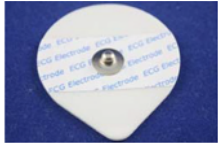
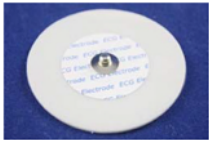
Brand	OEM No	Part No	Description	Image	
II Resting ECG Electrode Recommended for Nihon Konden, Fukuda, NEC, Kenz, China	H068K	MPK013A	Limb Electrode Perfect for Din3.0,4 pcs/set		
		MPK013B	Limb Electrode Perfect for Banana 4.0,4 pcs/set		
		MPK013D	Limb Electrode Perfect for Din3.0 and 4.0,4 pcs/set		

all Resting ECG Recommended for GE-Marquette, Schiller, Bionet, Mortala, Burdick	40494E	MPK013C	Adult Multi Purpose Limb Electrode for Banana4.0, Din3.0 and snap,Agcl,4 pcs/set			
		MPK013F	Adult Multi Purpose Limb Electrode for Banana4.0, Din3.0 and snap,Agcl,4 pcs/set			
		MPK013G	Pediatric Multi Purpose Limb Electrode for Banana4.0, Din3.0 and snap,Agcl,4 pcs/set			
Disposable ECG Electrode		MPK039I	Adult foam,50mm	50 pcs/bag,2000 pcs/box		
		MPK039J	Adult foam,55mm	50 pcs/bag,2000 pcs/box		
		MPK039K	Pedia foam,43mm	50 pcs/bag,2000 pcs/box		
		MPK039L	infant foam,30mm	100 pcs/bag,4000 pcs/box	